

Instruction

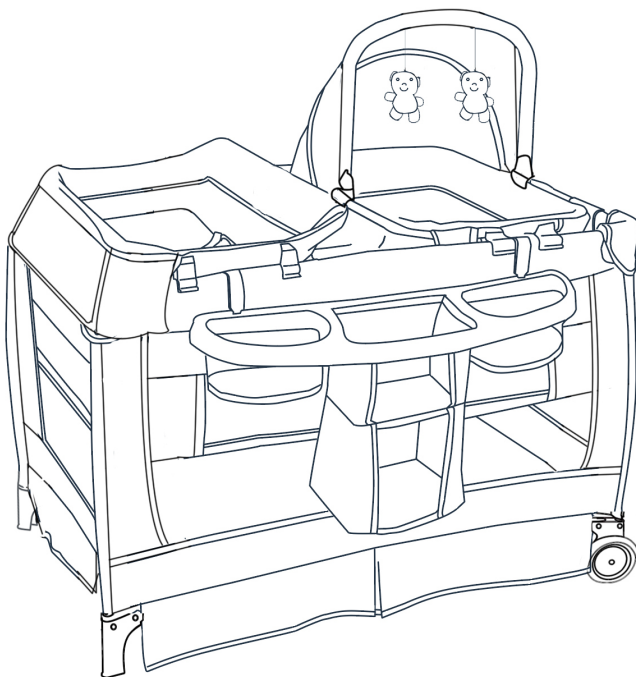

NATURE INTERNATIONALTRADING
INC.597 BEAVER CREEK CT,
BRIGHTION,CO 80601
Email Add:tfsservices@163.com

USER'S MANUAL

Baby Playard
ETD058

KEEP INSTRUCTIONS FOR FUTURE USE

Read all instructions before assembling and using the product.
Never use this product if any parts are missing, damaged, or broken. Contact seller for replacement parts and instructional literature if needed. Never substitute parts.

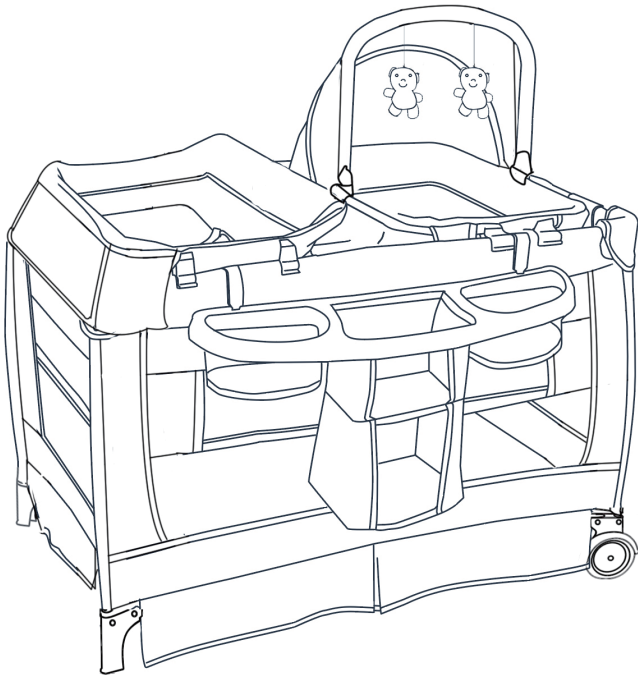

Instruction

NATURE INTERNATIONAL TRADING
INC. 597 BEAVER CREEK CT,
BRIGHTON, CO 80601

Before You Start

Please read all instructions carefully and keep it for future reference.

General Warnings:

- ⚠ **Attention:** To prevent possible injury by entanglement, remove this toy when the child starts trying to get up on its hands and knees in a crawling position.
- ⚠ **Danger!** Keep all small parts and packaging materials for this product away from babies and children, otherwise they may pose a choking hazard.
- ⚠ The product must be installed and used under the supervision of an adult.
- ⚠ Read through each step carefully and follow the proper order.
- ⚠ Remove all Packaging, separate and count all parts and hardware before Installation.
- ⚠ Please ensure that all parts are correctly installed, incorrect Installation can lead to a Danger.
- ⚠ We recommend that, where possible, all items are assembled near to the area in which they will be placed in use, to avoid moving the product unnecessarily once assembled.
- ⚠ Ensure a secure surface during construction, and place the product always on a flat, steady and stable surface.

WARNING

Playard Warnings

 **WARNING:** Failure to follow these warnings and the instructions could result in serious injury or death. This product including side rails, must be fully erected prior to use. Make sure latches are secure.

SUFFOCATION HAZARD

INFANTS HAVE SUFFOCATED:

- In gaps between a mattress too small or too thick and product sides
- On soft bedding
Never add a mattress, pillow, comforter, or padding. Use only the mattress provided by manufacturer.
- The playard mattress/pad is specially designed to prevent suffocation. The playard mattress/pad has a solid base, which must be at least 40 in. long and 28 in. wide and not more than 1 in. thick in order to meet safety standards. Using a thicker or a different sized mattress/pad may allow a child's head to get between mattress/pad and the side of the playard causing suffocation.
- To reduce the risk of SIDS, pediatricians recommend healthy infants be placed on their back to sleep, unless otherwise advised by your physician.
- ALWAYS place child on back to sleep.
- **NEVER use plastic shipping bags or other plastic film as mattress covers not sold and intended for that purpose.** They can cause suffocation.
- **NEVER use a water mattress with this product.**

FALL HAZARD: Always check that the bassinet is securely locked on the base/stand by pulling upwards on the bassinet.

 **WARNING: STRANGULATION HAZARD:** NEVER LEAVE INFANT IN PRODUCT WITH SIDES DOWN. Infant may roll into space between pad and loose mesh side causing suffocation.

- Strings can cause strangulation! NEVER place items with a string around a child's neck such as hood strings or pacifier cords. **NEVER suspend strings over playard or attach strings to toys.**

WARNING

- **NEVER** place the playard near a window where cords from blinds or drapes can strangle a child.
- Child can become entrapped and die when improvised netting or covers are placed on top of a playard. Never add such items to confine child in playard.
- **NEVER** leave child in product with sides lowered. Be sure sides are in raised and locked position whenever child is in product.

WARNING: See playard floor and side rails for warnings.

- The playard, including side rails, must be fully erected prior to use.
- Make sure latches are secure.
- Discontinue use of the product when child is able to climb out or has reached the height of 35 in. (890 mm), or 30lbs. (13.6kg)
- When child is able to pull to standing position, remove bumper pads, large toys and other objects that could serve as steps for climbing out.
- **ALWAYS** provide the supervision necessary for the continued safety of your child. When used for playing, never leave child unattended. Child in crib must be under supervision at all times.
- **ALWAYS** ensure that the playard, changing table, and the Portable Bassinet are safe by checking regularly, before placing the child in it, check that every part is properly secured in place.
- **NEVER** leave the Bassinet in place when child is in playard.
- **NEVER** leave Changing Table in place when child is in the playard.
- **NEVER** leave Portable Bassinet in place when child is in the playard. Only one child can use the Playard/Nursery Center at any time.
- **NEVER** use this product if there are any loose or missing fasteners, loose joints, broken parts, or torn mesh/fabric. Check before assembly and periodically during use.
- This product is not intended for commercial use.

AVERTISSEMENT

IMPORTANT! To ensure safe operation of your playard, please follow these instructions carefully. Please keep these instructions for future reference.

IMPORTANT! Before assembly and each use, inspect this product for damaged hardware, loose joints, missing parts or sharp edges. NEVER use if any parts are missing or broken.

IMPORTANT! Adult assembly is required.

MAINTENANCE

MAINTENANCE AND CLEANING INSTRUCTIONS:

Use only household mild soap and warm water.

DO NOT USE BLEACH.

DO NOT MACHINE WASH.

PARTS

Check the parts list on the back cover to make sure you have all the parts for this model before assembling the playard.



Playard

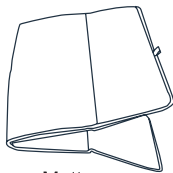

Mattress

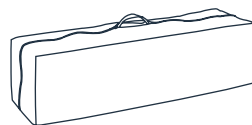

Travel / Storage Bag

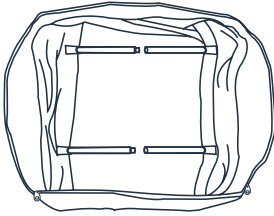

Large bassinet with metal support tubes

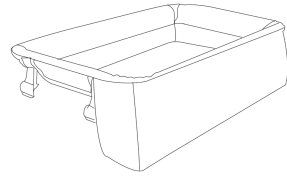

Changing Table

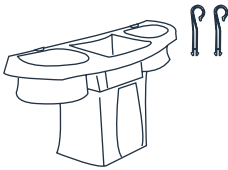

* Parent Organizer

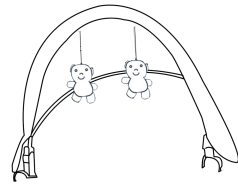

Canopy with toys

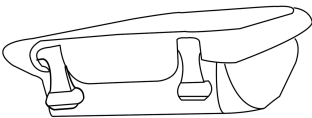

**Portable bassinet

ASSEMBLY

TO ASSEMBLE PLAYARD



Playard

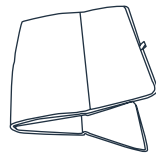

Mattress

ATTENTION: Playard must be fully assembled and securely locked before installing or using other accessories.

- 1) • Unzip bag and remove Playard frame (Fig. 1). Undo the Fasten straps and set the Mattress aside.
DO NOT push center down yet.



Fig. 1

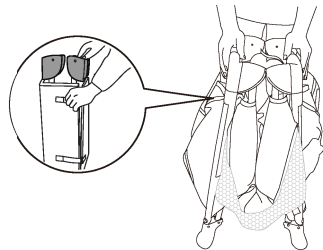

- 2) • While keeping the bassinet bottom base high, pull up the short bars in a quick upward motion to lock into place.
IMPORTANT: There are two unlocking mechanisms on each bar, please try to pull it quickly and avoid grabbing the center unlocking mechanisms (Fig. 2a) .
- While keeping the bassinet bottom base high, pull up the long bars in a quick upward motion to lock into place.
IMPORTANT: If a top bar does not lock into place, pull the base higher and try again(Fig. 2b).

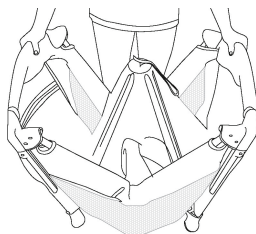

Fig.2a

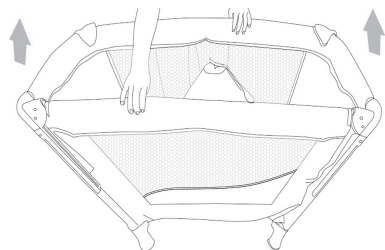

Fig.2b

ASSEMBLY ASA

- 3) • Once all four (4) top rails are locked in place, push down on the center handle (Fig. 3a). The center mechanism automatically locks in place.

IMPORTANT: Test each top rail by pushing down slightly to confirm each is rigid and securely in place before use (Fig. 3b).

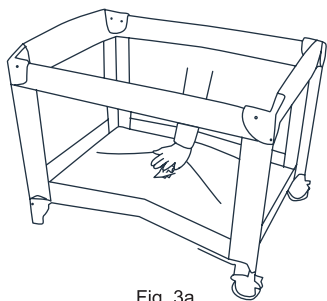

Fig. 3a

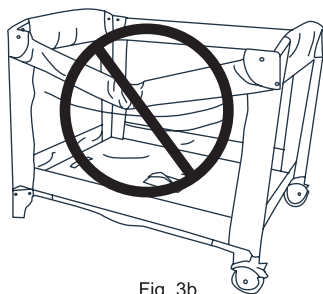

Fig. 3b

ASSEMBLY

For already assembled Playard you may skip to page 14 for the accessories instructions. To install mattress into the playard proceed to Step 4.

- 4) • Place the Mattress on the floor of the Playard with the padded side facing up (Fig. 4).

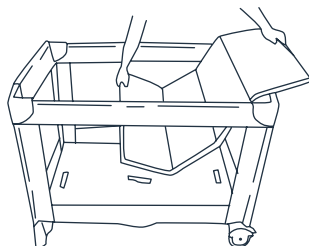

Fig. 4

-
- 5) • Insert the hook & loop fasteners located on the underside of the mattress through the slots in the floor of each end of the playard (Fig. 5a). Fasten the hook and loop fasteners to the underside of the playard floor to prevent the mattress from moving (Fig. 5b).

IMPORTANT: The handle located in the center of the Playard floor **MUST** remain raised (Approx. 45.7 cm or 18 inches) while locking the side rails in place. If the center is not raised the rails will **NOT** lock.

If you experience difficulty and one side of the rail will lock but the other side will not then, unlock the rail by squeezing the release in the center and try again.

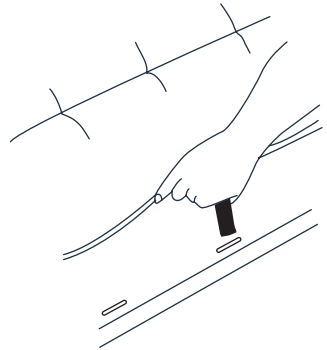

Fig. 5a

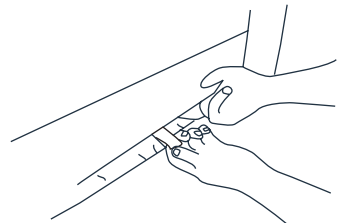

Fig. 5b

- 6) • To operate the brakes on the wheels, press downward on the brake levers. To release, lift upward on the lever (Fig. 6).

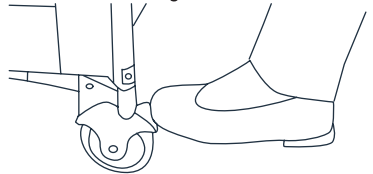

Fig. 6

FOLDING PLAYARD

- 7) • Release the hook and loop fastener holding

or the Bassinet and set the mattress aside. **DO NOT** unlock top rails yet, center of floor handle must be raised before top rails will unlock.

- Pull the red strap upwards and raise the center as high as the top rails (Fig. 7). Gather the Legs and Wheels together towards the center as close as possible so that they nearly touch.

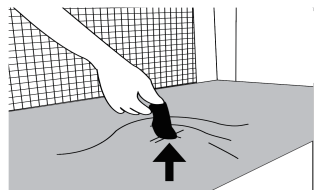

Fig. 7

-
- 8)** • Locate the rail latch release in the center and bottom side of each rail. Squeeze the lever with two hands until the rail releases the two tubes (Fig. 8a), then push down (Fig. 8b). **NOTE:** If the top rail(s) do not release completely, **DO NOT FORCE!** Lift the center of floor higher. Both tubes must be released for the top rail to fold.

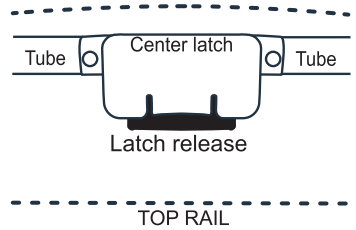

Fig. 8a

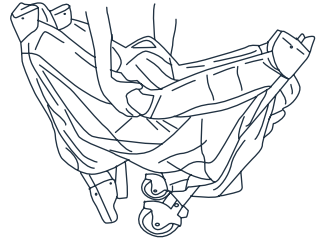

Fig. 8b

- 9)** • Gather all four (4) corners and the center together tightly (Fig. 9). W with padded side facing inward.



Fig. 9

- 10)** • Secure the hook and loop fasteners by feeding them through the loops on the end of the mattress then fold them back onto themselves (Fig. 10).
- Place folded Playard into carry bag so that the handle comes through the opening between each side of the zipper.

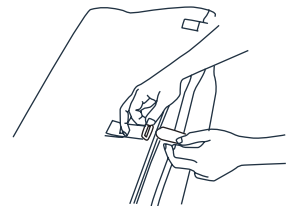



Fig. 10

WARNING

ACCESSORIES

Bassinet & Cradles Warnings:

-  **WARNING:** Failure to follow these warnings and the instructions could result in serious injury or death.
- WARNING FALL HAZARD:** To help prevent falls, do not use this product when the infant begins to push up on hands and knees or has reached the height of 25 in. (635 mm), weight of 22 lbs. (10 kg), whichever comes first.
- **ALWAYS** check that the large bassinet is securely locked on the base/stand by pulling upwards on the large bassinet bed.

SUFFOCATION HAZARD **Infants have suffocated:**

- In gaps between extra padding and sides of bassinet/ cradle and
- On soft bedding
Use only the pad provided by the manufacturer.
NEVER add a pillow, comforter, or another mattress for padding.
- Always attach large bassinet securely. If the large bassinet is not secured, at all locations child could get neck trapped between large bassinet and playard frame.
- Do not place items with a string around a child's neck such as hood strings or pacifier cords. Strings can cause strangulation! Do not suspend strings over the large bassinet or attach strings to toys.
- **NEVER** use plastic shipping bags or other plastic film as mattress covers not sold and intended for that purpose. They can cause suffocation.
- Use the large bassinet with only one child at a time.
- **NEVER** place a child under the large bassinet.



WARNING

- The Playard must be fully assembled and installed before using.
- The playard, including side rails, must be fully erected prior to use. Make sure each latch is secure.
- **NEVER** leave the large bassinet in place when child is in playard.
- **NEVER** place a child under the large bassinet.
- **NEVER** leave Changing Table in place when child is in the playard.
- **NEVER** leave the Portable Bassinet in place when child is in the playard. Only one child can use the Playard at any time.
- To reduce the risk of SIDS, pediatricians recommend healthy infants be placed on their back to sleep, unless otherwise advised by your physician.
- **ALWAYS** place child on back to sleep.
- **ALWAYS** provide the supervision necessary for the continued safety of your child. **NEVER** leave children unattended.
- If a sheet is used with the mattress/pad, use only the one provided by Babyjoy or one specifically designed to fit the dimension of the playard mattress.
- Discontinue use of the large bassinet and the changing table when child begins to push up on hands and knees or has reached the height of 25 in. (635 mm), weight of 22 lbs. (10 kgs) or 3 months old, whichever comes first.
- Child can become entrapped and die when improvised netting or covers are placed on top of a playard. Never add such items to confine child in playard.

SUFFOCATION HAZARD: Infant carrier can roll over on soft surfaces and suffocate child. **NEVER** place carrier on beds, sofas, or other soft surfaces.

FALL HAZARD: **ALWAYS** check that the large bassinet is securely locked on the base/stand by pulling upwards on the large bassinet.

ASSEMBLY

TO ASSEMBLE LARGE BASSINET

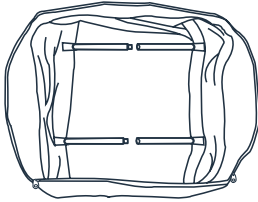

Bassinet with metal support tubes

ATTENTION: Playard must be fully assembled and securely locked before installing or using the Bassinet feature (See To Assemble Playard section). You will need to remove the mattress from the bottom of the Playard to use inside your Bassinet.

- 11) • Connect opposing Mattress Support Tubes that are attached to the bottom of the Bassinet (Fig. 11a).
- Before placing the Mattress into the Bassinet, make sure Mattress Support tubes are connected (Fig. 11b).

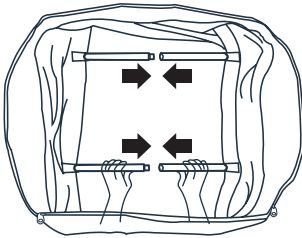

Fig. 11a

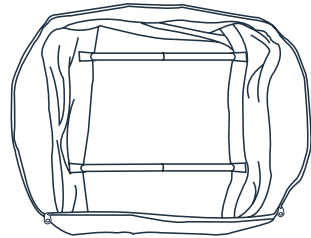

Fig. 11b

- 12) • Position the Bassinet over and down into the fully assembled Playard. Zip up the second sleeping layer (Fig. 12). Insert the plug (A) into the lock (B) and snap at the sound of "click".

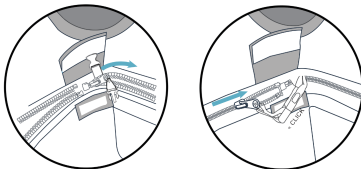
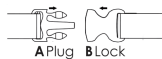
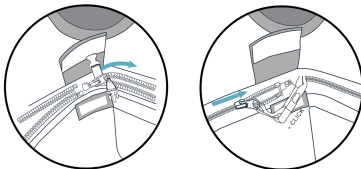

Fig. 12



-
- 13)** • Place the Mattress into the Bassinet with the padded side facing upward (Fig. 13).

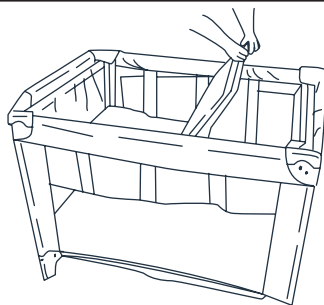

Fig. 13

TO REMOVE LARGE BASSINET

- Remove Mattress from Bassinet. Disconnect opposing Mattress Support Tubes. Press the plug inward and pull the latch outward to open, unzip and lift bassinet.



TO ASSEMBLE CHANGING TABLE

ATTENTION:

locked before installing or using the changing table feature (See To Assemble Playard and large bassinet section)

Changing Table:

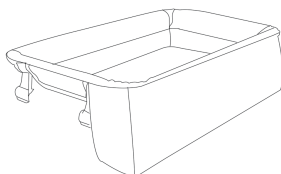

(1) Changing Table

ACCESSORIES

Changing Table:



WARNING FALL HAZARD: Children have suffered serious injuries after falling from changing tables. Falls can happen quickly.

- **STAY** within arm's reach.
- **ALWAYS** secure the changing table to the playard

SUFFOCATION HAZARD : Babies have suffocated while sleeping on changing tables. Changing tables are not designed for safe sleep.

- **NEVER** allow baby to sleep on changing table.
- **NEVER** leave the changing table in place when the child is in the large bassinet or the playard.
- Discontinue use of the large bassinet and the changing table when child begins to push up on hands and knees or has reached the height of 22 in. (558.8 mm), weight of 22 lbs. (10 kg) or 3 months old, whichever comes first.
- Do not use changing table if it is damaged or broken.

- 14)** • Lay the changing table cover on a flat surface with the back side facing up (Fig. 14a).
Ensure the clips are perpendicular to the bars during preparation (Fig. 14b).
- Insert both ends with the push pins into the bars (Fig. 14c). Ensure 2 pins click into position on 2 connection points (Fig. 14c).
 - Close the covering by using the hook and loop fasteners on the flap (Fig. 14d).

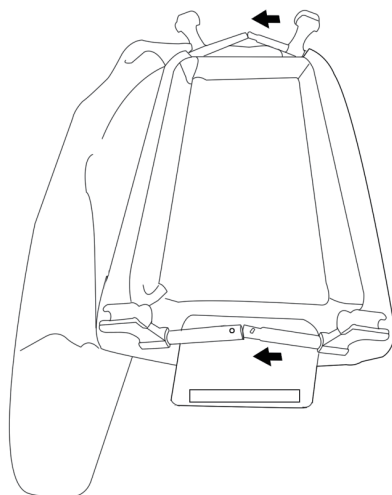

Fig. 14a

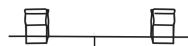

Fig. 14b



Fig. 14c

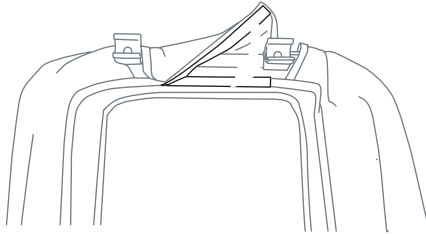

Fig. 14d

TO SECURE THE CHANGING TABLE TO THE PLAYARD

IMPORTANT! When the changing table is on the upper position the changing table must be secured to the playard frame by using the snap buttons straps or fasteners provided.

- 15)** • Locate the 4 clip fasteners on the bottom of the changing table (Fig. 15a).
- To attach the changing table to the playard, lower the changing table into the large bassinet. Push down on the 4 clips to secure it onto the large bassinet railing. Close the covering by using the hook and loop fasteners on the flap (Fig. 15b).

NOTE: DO NOT use changing table on playard without the large bassinet (See To Assemble large bassinet section, pages 12 - 13) and securing the clips to playard.

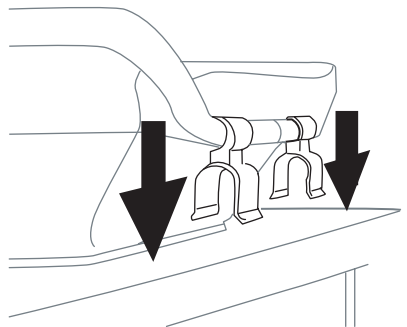

Fig. 15a

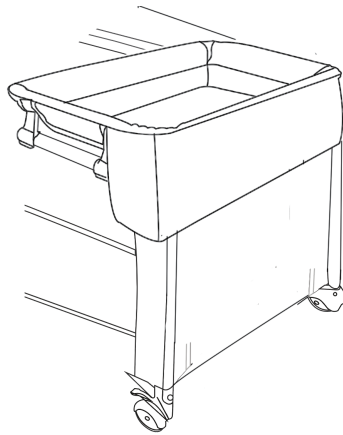
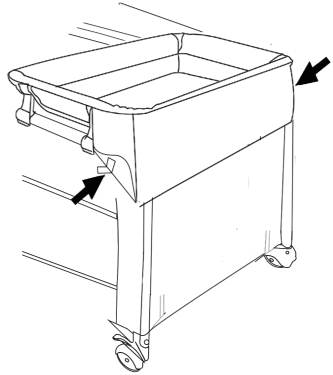
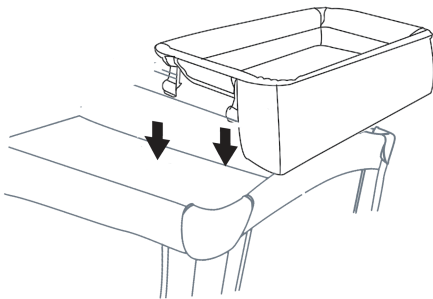

Fig. 15b

TO REMOVE CHANGING TABLE

- 17)** • Locate all 4 clip/fasteners on the changing table. Pull up on all 4 clips to release them from the playard frame (Fig. 17a).

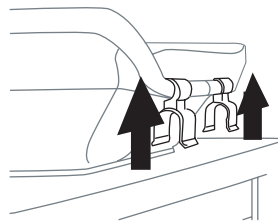
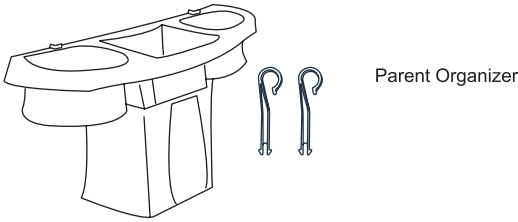

Fig. 17a

PARENT ORGANIZER ASSEMBLY



Parent Organizer

- 18)** • Parent Organizer: Position each hook so that the hooked end is facing the rear side of the organizer. Press the hook down firmly into the slot until it snaps into place (Fig. 18a). Diaper Stacker: Skip to step 18b.

- Connect the Parent Organizer/Diaper Stacker to the Playard by sliding the two (2) connecting clips over an open portion of the top rail of the Playard (Fig. 18b).

NOTE: The Parent Organizer / Diaper Stacker can only be installed on open sides of the Playard where the connecting clips can easily be attached without interfering with other features.

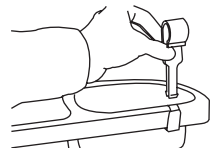

Fig. 18a

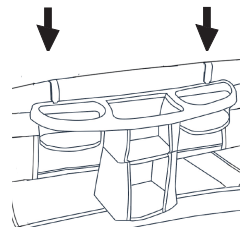
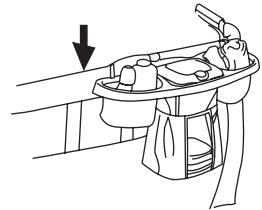

Fig. 18b

WARNING

ACCESSORIES

Warnings for Toy Accessories - Canopy with toys:

WARNING:

- Possible entanglement injury.
- Keep out of baby's reach.
- Remove Canopy with toys when baby begins to push up on hands and knees. Recommended use from birth to 5 months.
- Toys are not intended to be mouthed by the baby and should be positioned clearly out of reach of the baby's face and mouth.
- **ALWAYS** attach all provided fasteners (strings, straps, clamps, etc.) tightly to playard according to these instructions. Check frequently.
- Do not add additional strings or straps to attach to any other crib or playpen.
- The Toybar/Mobile/Canopy with toys is intended for visual stimulation and not to be grasped by the child.

ASSEMBLY

TO ASSEMBLE PORTABLE BASSINET

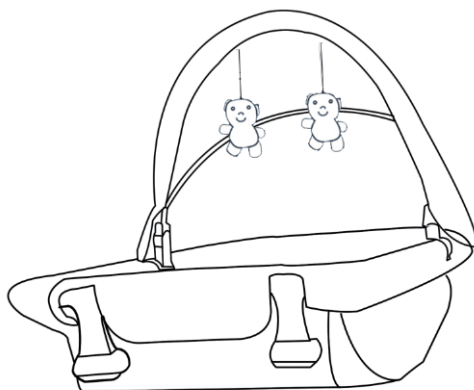

WARNING

 **WARNING:** Failure to follow these warnings and the instructions could result in serious injury or death.

FALL HAZARD: To prevent falls, stop using the product when infant:

- Begins to wiggle out of position or turn over in the product, head touches the upper edge of the product, reached the height of 25 in. (635 mm), weight of 22 lbs.(10 kgs) (approximately 3 months of age).
- **ALWAYS** use restraint system if a restraint system is provided with the product.

SUFFOCATION HAZARD **Infants have suffocated:**

- In gaps between extra padding and sides of bassinet/ cradle and
- On soft bedding
Use only the pad provided by the manufacturer. **NEVER** add a pillow, comforter, or another mattress for padding.
- When trapped between product and adjacent surfaces.
- **ONLY** use POTRTABLE BASSINET on playard when it is securely attached.
- If a sheet is used with the pad, use only the one provided by Kinder King or one specifically designed to fit the dimension of the POTRTABLE BASSINET bassinet mattress.
- **NEVER** use POTRTABLE BASSINET in different product.

 **WARNING:** **NEVER** leave child unattended.

SUFFOCATION HAZARD: Infant carrier can roll over on soft surfaces and suffocate child. **NEVER** place carrier on beds, sofas, or other soft surfaces.



WARNING

FALL HAZARD: Child's activity can move carrier. **NEVER** place carrier on counter tops, tables, or any other elevated surface. **NEVER** use this carrier as a means to transport an infant in a motor vehicle. Infant carriers not intended for use as infant restraint devices in motor vehicles.

- To reduce the risk of SIDS, pediatricians recommend healthy infants be placed on
- The playard, including side rails, must be fully erected prior to use. **MAKE SURE EACH LATCH IS SECURE.**
- Strings can cause strangulation! **NEVER** place items with a string around a child's neck such as hood strings or pacifier cords. **NEVER** suspend strings over portable bassinet or attach strings to toys.
- **WARNING:** Possible entanglement injury with toys attached. Keep out of baby's reach.
- Do not use portable bassinet or place on playard when baby begins to push up on hands and knees.
- **NEVER** place product near a window where cords from blinds or drapes can strangle a child.
- Always provide the supervision necessary for the continued safety of your child. **NEVER** leave child unattended.
- **NEVER** use plastic shipping bags or other plastic film as mattress covers not sold and intended for that purpose. They can cause suffocation.
- Use portable bassinet with only one child at a time.
- **DO NOT** use large bassinet when using Portable Bassinet.
- **NEVER** place a child under the portable bassinet.
- **NEVER** store the portable bassinet in the playard while in use.
- The large bassinet must be fully assembled and installed before using.
- To help prevent heat build-up inside the playard and to avoid overheating your child, when using the portable Bassinet **NEVER** use an outdoor canopy.
- **NEVER** leave Portable Bassinet in place when child is in the playard. Only one child can use the Playard at any time.
- **ALWAYS** ensure that the playard, changing table, and Portable Bassinet are safe by checking regularly, before placing the child in it, that every part is properly and securely in place.
- **NEVER** use this product if there are any loose or missing fasteners, loose joints, broken parts, or torn mesh/fabric. Check before assembly and periodically during use.

ASSEMBLY

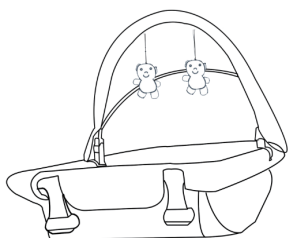

**Portable bassinet

- 19)** • Lay the bassinet cover on a flat surface with the back side facing up (Fig. 19a).
Ensure the clips are perpendicular to the bars during preparation (Fig. 19b).

- Insert both ends with the push pins into the bars (Fig. 19c). Ensure 2 pins click into position on 2 connection points (Fig. 19c).
- Close the covering by using the hook and loop fasteners on the flap (Fig. 19d).

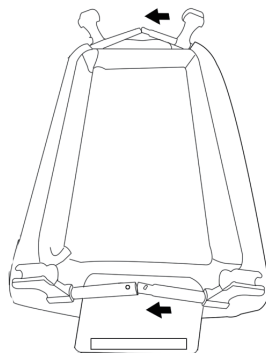

Fig. 19a

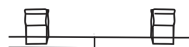

Fig. 19b



Fig. 19c

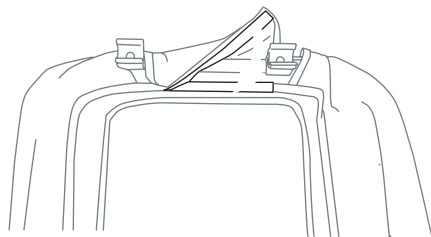

Fig. 19d

- 20) •** Assemble 2 straps as shown (Fig.20a).
Insert the both plastic clips of the canopy onto the bassinet railing (Fig.20b).

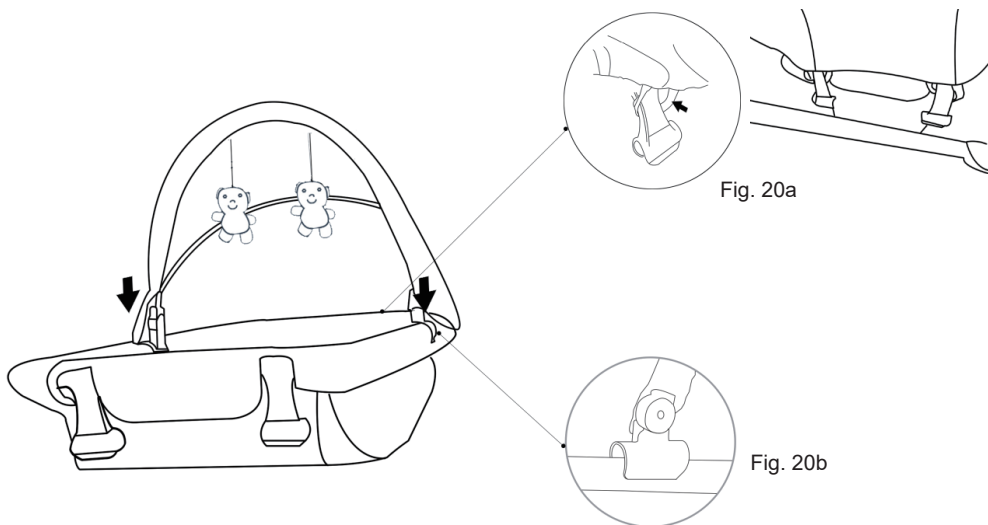

Fig. 20a

Fig. 20b

-
- 21)** • To attach the portable bassinet to the playard, lower the portable bassinet into the large bassinet. Push down on the 4 clips to secure it onto the large bassinet railing (Fig. 21).

ATTENTION: Playard and large bassinet must be fully assembled and securely locked before installing or using the Portable bassinet feature. (See To Assemble Playard and large bassinet sections, pages 7-13).

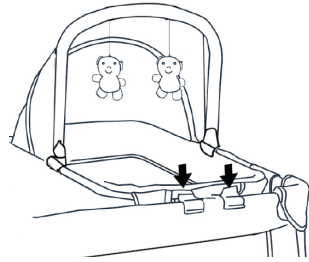

Fig. 21

TO FOLD REMOVABLE PORTABLE BASSINET

⚠ WARNING: Care must be taken when folding and unfolding to prevent finger entrapment.

CAUTION: Do not allow children near while folding and unfolding.

- 22)** • Remove the Portable Bassinet from the Playard and place on a flat surface (Fig. 22).

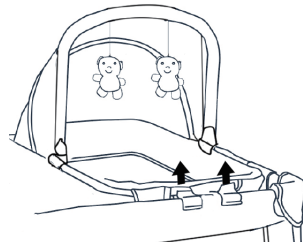

Fig. 22

AFTER-SALE SUPPORT

If you have any questions, please contact us via email (tfservices@163.com). We will be happy to serve you and guarantee a 100% satisfactory treatment plan. If you want to know more about Kinder King, please visit our official website: <https://kinderking.store>



tfservices@163.com