

Assembly Instructions

Caution : You should read this before proceeding

Please look in chair base for hardware pack.

CHAIR



Parts List

Label	Picture	Description	QTY
A	A small, curved, woven chair seat, shown in a perspective view. It has a dark, textured surface and a light-colored inner rim.	Chair Seat	1
B	A chair base consisting of four thin, slightly tapered legs and a central support structure. The legs are arranged in a square pattern, and the central support is a small, rectangular frame.	Chair Base	1

Hardware

Label	Picture	Description	QTY
①		Flat Washers (φ6mm)	5
②		Spring Washers (φ6mm)	5
③		Screws (M6x20mm)	5
④		Allen Key	1

Assembly Preparation

Before Beginning Assembly:

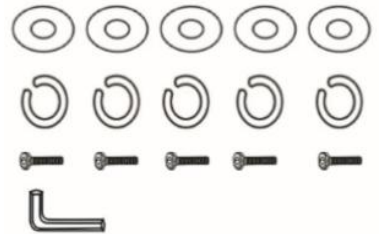

- Read instructions, cover to cover-



- Have 2 adults on hand for assembly-



- Do not assemble on flooring or carpet-



- Assemble on a clean non-marring surface (packing foam)-



- Save all packaging until finished-

Assembly Steps

Overview

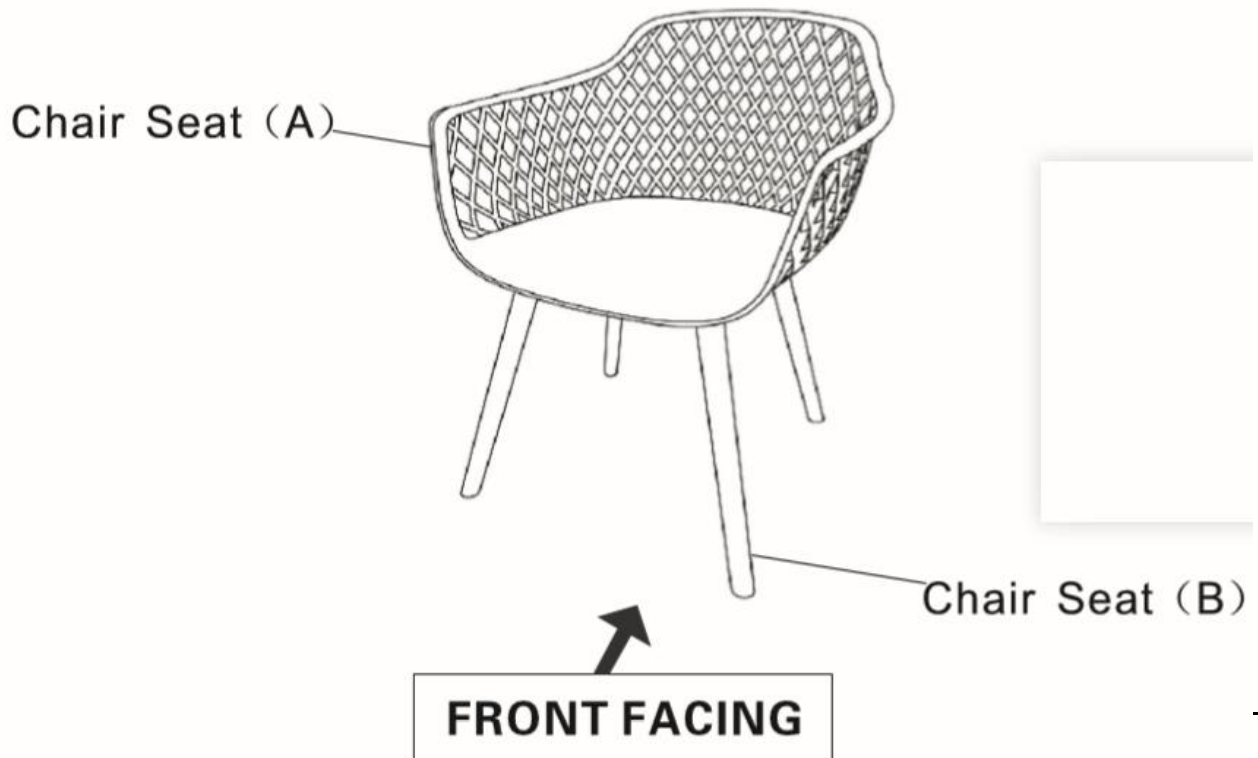

assemble. To give you an overview of the Chair parts, the above picture is to help you put the various parts into perspective. Please read through the instructions below to familiarise yourself with the parts and steps before assembly.

Step 1



Unpack and place all parts on a clean, non-marring surface.

Step 2

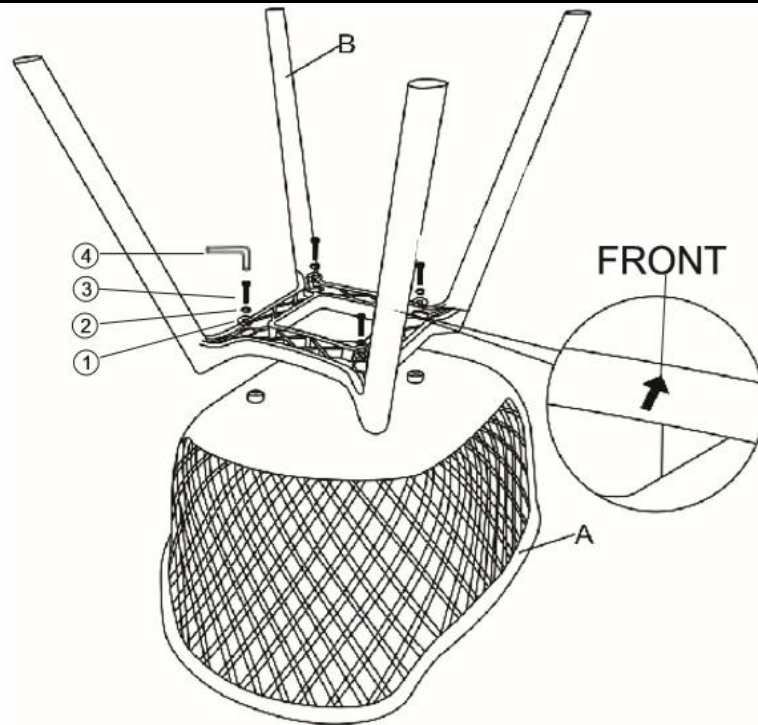

Place the Chair Seat (A) with its bottom side facing upwards onto a clean, soft surface to avoid any scratches or damage to the product.

Align the Mounting Position of the Chair Seat (A) with the Mounting Position of the Chair Base (B) as shown above.

Then, affix the Chair Seat (A) to the Chair Base (B) using Flat Washers (①), Spring Washers (②), Screws (③) and the Allen Key (④).

DO NOT FULLY TIGHTEN THE SCREWS AT THIS TIME.

Step 3

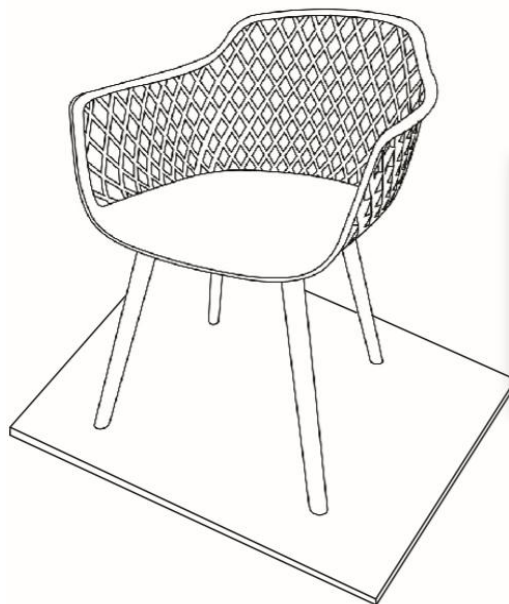

Turn the Chair up. Place the Chair on a LEVEL SURFACE. Inspect it and make sure all parts are adequately connected. Gently and carefully, sit into the Chair. This will help align all the parts at all the joint areas.

Then get off the Chair, and in a sequential manner, proceed to tighten all screws. Please turn each screw 6 times, so they are neither too loose nor too tight. To tighten the Screws, do secure assistance from your adult partner(s).

You may be required to turn the Chair, to gain easy access to the secure points. Turn the Chair in a synchronised manner.











CAUTION 1: When tightening these screws, tighten sequentially.

DO NOT tighten any screw fully and then move towards the next one.

This would cause the frame to warp. If the chair wobbles after tightening, loosen the screws and execute this same process. WARNING!! IF the Chair IS NOT STABLE , IT COULD LEAD TO DAMAGING THE PRODUCT. Ensure all screws are fully locked into position. The Chair is ready to be used.

Caution 2: This Chair can only be used on a flat, level surface.

Care & Maintenance

-  ● Do not put hot items directly on furniture surface
 -  ● Do not clean furniture with harsh cleansers or polish.
 -  ● To obtain the longest lifespan of your outdoor products, minimizing exposure to direct sunlight is recommended.
 -  ● Children should not climb or jump on the furniture.
 -  ● Do not write on furniture without a padded barrier to protect the surface.
 -  ● To obtain the longest lifespan of your outdoor products, avoid extended and lengthy exposure to rain, snow, and direct sunshine. Whenever possible cover the product and /or place under patio or awnings.
 -  ● Not for commercial use. For residential use only .
 -  ● Stains may be removed with mild soap solution and damp cloth.
 -  ● Keep away from sources of ignition.
-
-  ● Dust and pick-up spills using a clean, non-colored, lint-free cloth.