

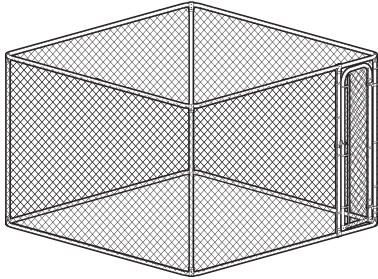

ALEKO 7.5x7.5x4 Dog Kennel Step-by-Step Assembly Instructions

Finished size: 7 ½' x 7 ½' x 4' high, 56 ¼ square feet.



Tools needed:

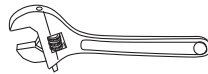

or

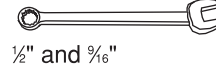

½" and ⅝"

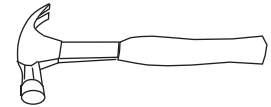

Step 1 CHECK PARTS BEFORE ASSEMBLY:

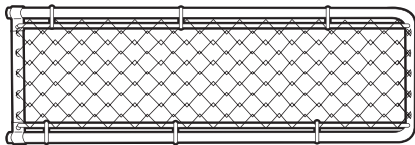

1 - gate

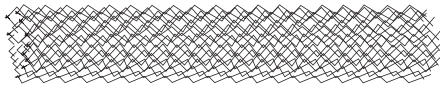

1 - roll chain link fabric

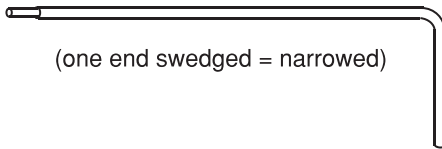

(one end swedged = narrowed)

8 - bent tubing (corner rail)



(both ends plain)

5 - straight tubing



(one end swedged)

8 - tubing (frame rail)



2 - tension rod



1 - Tie wires (Bag)



20 - Clamps

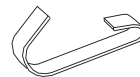

8 - Clips

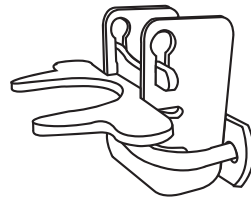

1 - gate latch



2 - male hinges



2 - female hinges

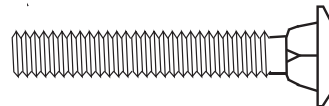

14 - carriage bolts



14 - hex nuts (⅝" hex nut)

Step 2 Assemble kennel on a level surface. Gather four corner rails and four frame rails swedged on one end. Point all swedged (narrowed) ends clockwise.

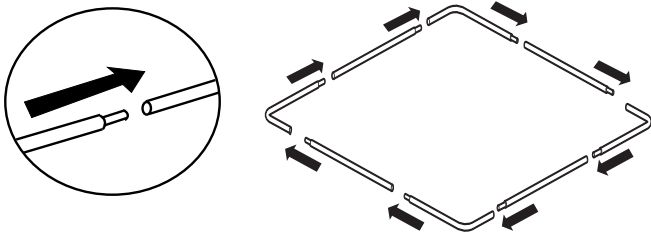

Step 3 Connect the bottom frame. Slip swedged ends of tubing into the next piece of tubing.

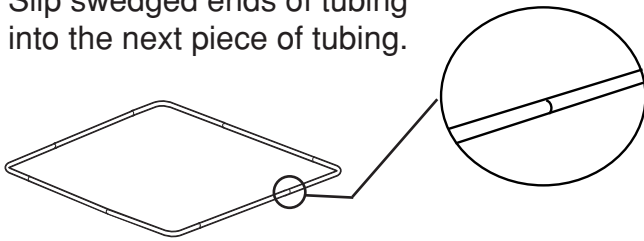

Step 4 Add uprights. Gather: four uprights, eight clamps, four medium bolts, four small nuts and a 1/2" wrench.

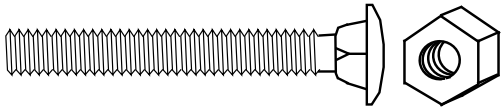

With the nut on top, clamp all posts to the bottom frame at each corner (as shown below)

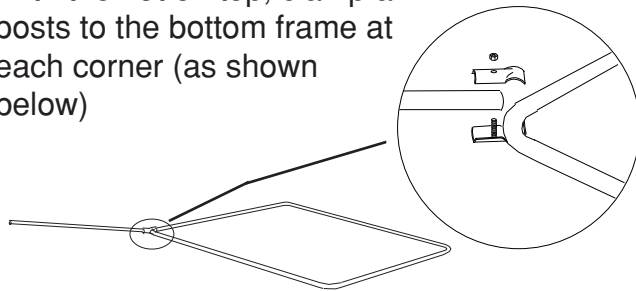

Stand corner posts up and tighten clamps.

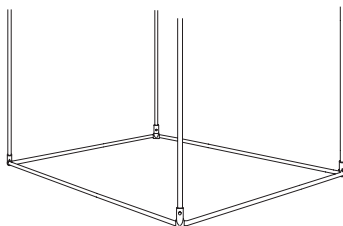

Step 5 Add top rails. Point all top rail swedges clockwise as the bottom frame. Connect them as shown to all posts. Tighten all clamps as you go.

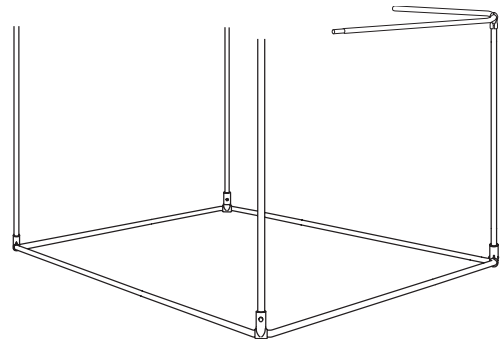
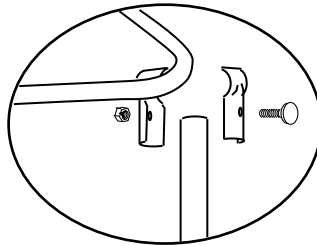

Step 6 Check that all posts are straight up and down.

Step 7 Add an upright post for the gate. The gate can be put 22 1/4" to either side of any of the post. **Do NOT have the gate span a joint in the frame. The frame can come apart at the swedged joint.**

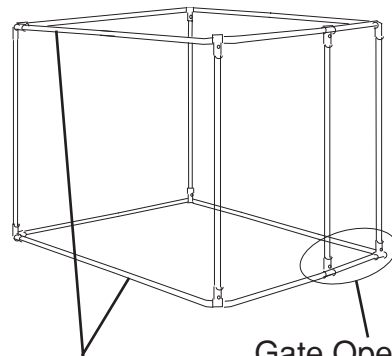

Note: All swedged joints will be loose until fence fabric is installed.

Gate Opening: 22 1/4" between posts.

Step 8 Install the gate.

1. Gather male and female hinges, 4 - carriage bolts with nuts, and the gate.

Note: Gate can open from either side.

2. Install the upper female hinge below the upper most gate clip (8B).
3. Install the lower female hinge directly above the bottom gate clip (8C).
4. Position the gate centered in the gate opening.
5. Attach bottom male hinge and slide up to meet bottom female hinge. Tighten securely (8C).
6. Attach top male hinge and slide down to meet top female hinge. Tighten securely (8B).
7. With an adjustable wrench, install the gate latch 24" from the ground (8A). *Note: The gate latch can be locked. Lock not provided.*

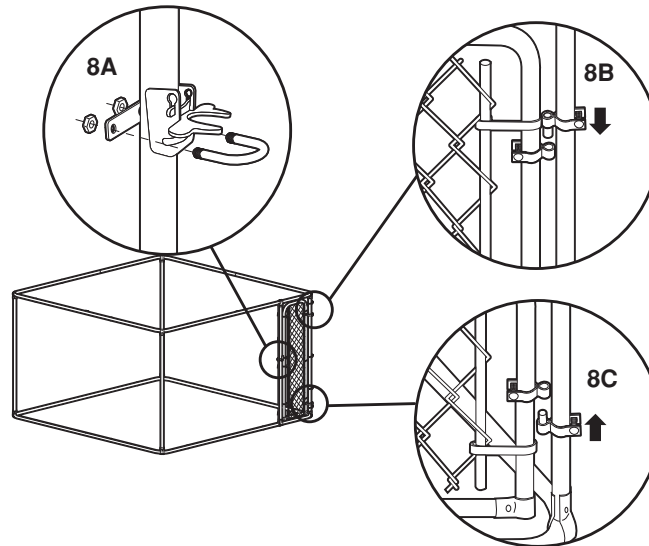

Next put on the fence fabric.

Note: Putting the fabric on is easy, except chain link fabric is strong and stiff and the roll is heavy, so a helper is recommended.

Tools needed

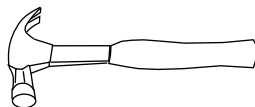

Step 9 Add fence fabric.

Gather 4 clips, one tension rod, package of tie wires, and the roll of wire.

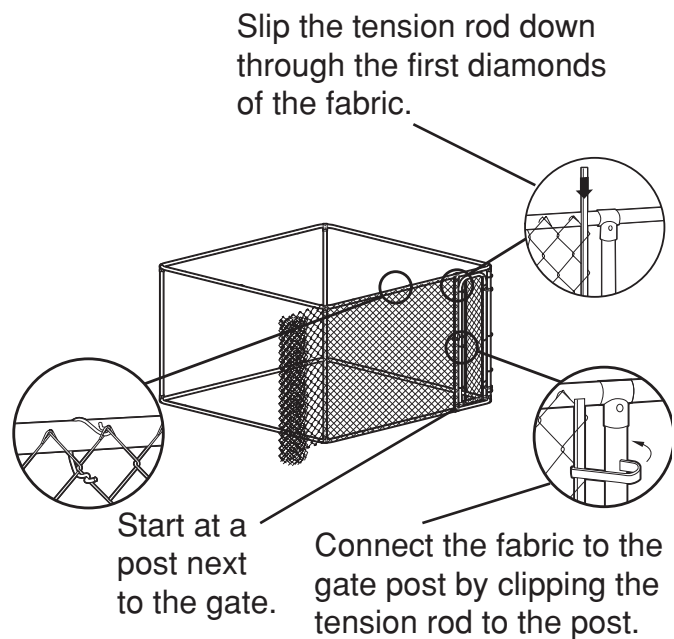

Unroll the fabric around the kennel. Loosely add a tie wire to the top frame about every 5 feet to keep the fabric from falling down.

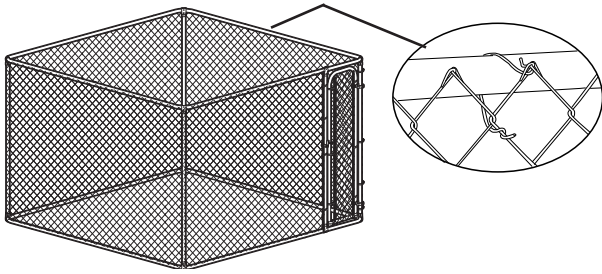

Step 10 Stretch the fabric Starting from the first post away from the gate, use a hammer to stretch the fabric as shown. Add tie wires to posts to hold the fabric stretched. Stretch fabric as tightly as possible. **Be sure all tie wires are on the same picket (wire) or the fabric will be crooked.** Then stretch and tie to the next post, until you go all the way around. Don't tie the last post (at the gate).

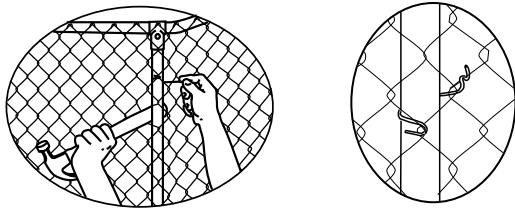

Step 11 Stretch the fabric as tightly as possible to the last post and select a fabric wire to cut, allowing 4 1/2" for the tension rod and clips.

Cut the fabric by holding the fabric loosely while you spin one of the pickets (wires) out.

Here's how:

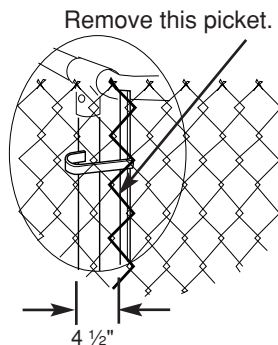
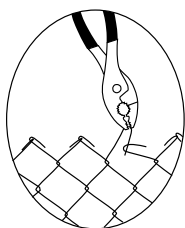

a. Undo the knuckle (loop) at the top and the knuckle at the bottom of the same picket (wire).

b. Unweave that picket by spinning it. **Be careful! Wire ends are sharp.**

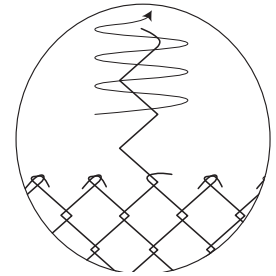

Install the tension rod and 4 clips.

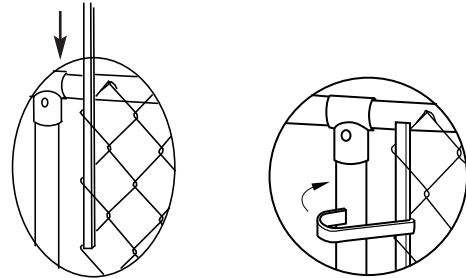

Step 12 Secure the fabric Beginning at the gate opening, attach a tie wire to every third diamond around the top, and every fifth around the bottom of kennel.

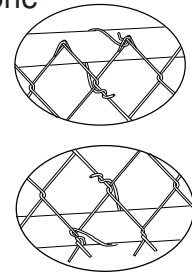

*Use any extra tie wires around bottom for added security.

Note: Attaching tie wires to the bottom is easier if you temporarily raise the bottom of the kennel onto bricks, blocks of wood, or the box the kennel came in.

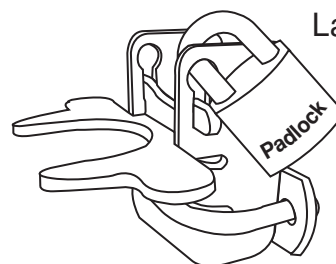

Latch can be locked!

Please - for your pet's safety - train your pet to become accustomed to his/her new home. Consult a professional for help.