

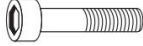





ASSEMBLY INSTRUCTION

Parts list :

| Ref | Part Name | Part Image | QTY | Ref | Part Name | Part Image | QTY |
|-----|-------------|---|------|-----|---------------|---|------|
| A | Top |  | 1pc | E | Bolt |  | 8pcs |
| B | Front leg |  | 2pcs | F | Spring washer |  | 8pcs |
| C | Back leg |  | 2pcs | G | Flat washer |  | 8pcs |
| D | Black cover |  | 1pc | H | Allen key |  | 1pc |

Step 1:

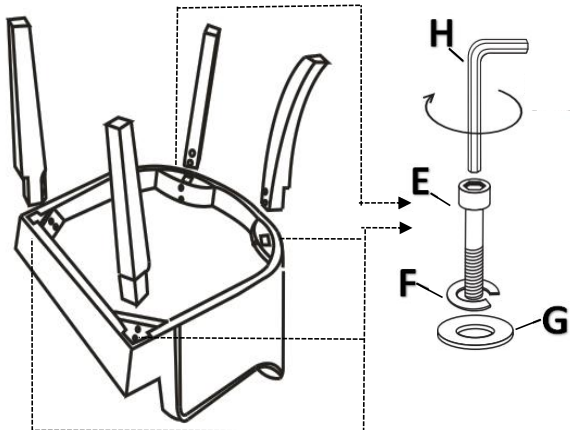

Step 2:

