



















# ASSEMBLY INSTRUCTION

**Before you begin, please follow assembly instruction carefully, then follow step by step.**

Read instruction carefully. See furniture Parts List and Hardware List for guidance. Be sure you have all parts before you start assembling. Place and assemble furniture on a clean flat soft surface, such as carpet, rug or carton to prevent being scratched.

## Reminder :

Please ensure that all surface and edges with colours / laminations are facing forward / outward.

HARDWARE LIST			QTY
A2		Screw m3.5 x 14mm	74
A4		Screw m3.5 x 20mm	4
A7		Screw m4 x 30mm	4
A17		Crosshead Screw 6.3 x 40mm	14
A18		Crosshead Screw 6.3 x 50mm	4
C5		Square Lock Set	1 Set
D4		Wood Dowel 6 x 25mm	8
E5		Soft Closing Hinge 5/8	6
H6		Handle 128mm	2
L2		Plastic Leg L Shape	4
N1		Allen Key	1
N3		Nail	35 (+-3)
P		Hanging Steel Pipe 18mm x 727mm	1
P1		Hanger 21	1
Q4		Plastic Shelf Support with Steel Pin	12
R1		L Bracket	2
S1		Door Catches	1
S2		Door Stopper	1
Y		Crosshead Cover	14

Each pack have contain different type hardware and size of screw for easy assemble. Please refer to page 2, check a screw size.

## CAUTION

MATERIAL USE LAMINATED PARTICLE BOARD, TO CLEAN USE SOFT, DRY CLOTH. DO NOT USE DETERGENT OR CHEMICAL. AVOID CONTACT WITH WATER AND DIRECT SUNLIGHT. TO BE ASSEMBLED ON A SOFT, DRY, CLEAN SMOOTH SURFACE.



USE OF POWER TOOLS TO ASSEMBLE THIS PRODUCT WILL INVALIDATE ANY CLAIM AND MAY DAMAGE THIS PRODUCT MAKING IT UNSAFE.

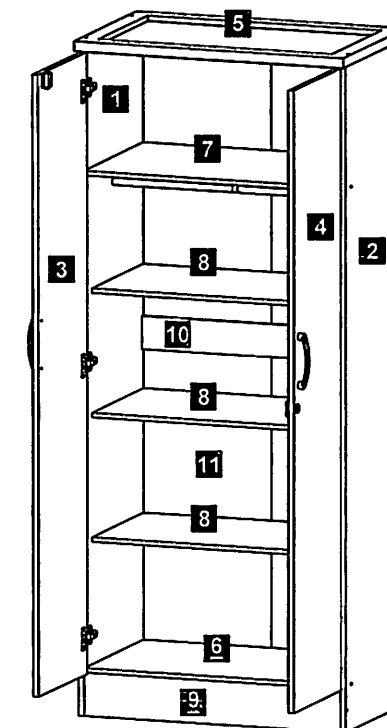
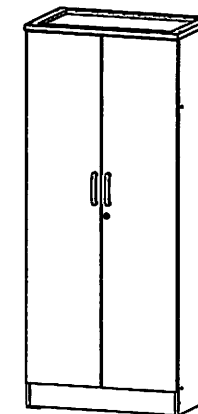

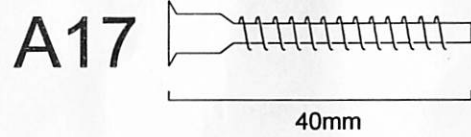
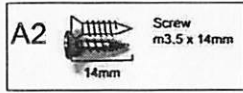
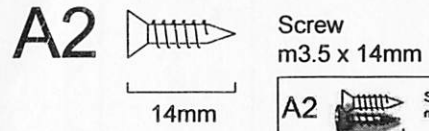

Crosshead Screw  
6.3 x 40mm

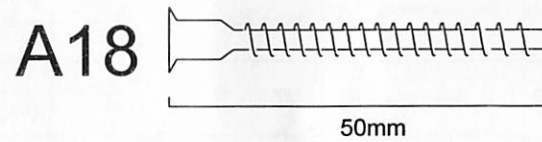
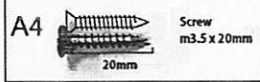
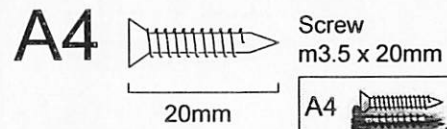
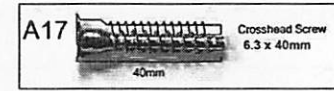

Crosshead Screw  
6.3 x 50mm

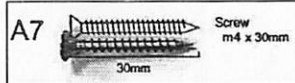
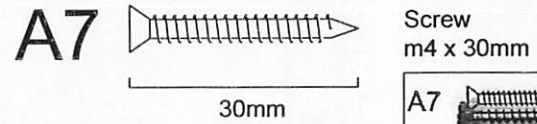
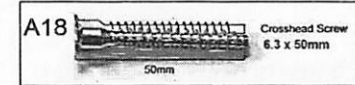

**STEP 1** First, assemble each hardware with the different size screw at both door panel no. 3 & 4.

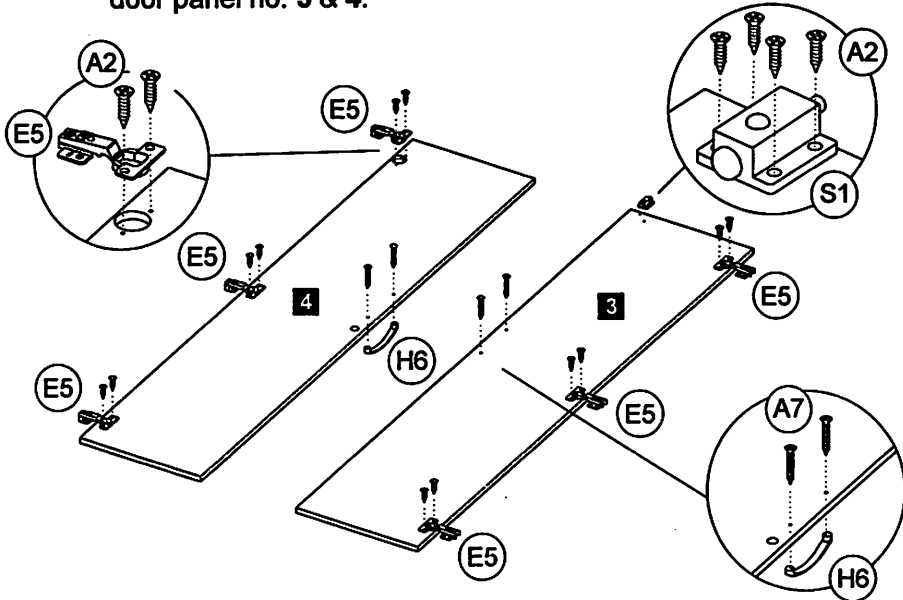

**STEP 2** Use Screw (A2) to assemble the Hanger (P1) at marking hole panel no. 7. Insert the Wood Dowel (D4) at both side of panel no. 9.

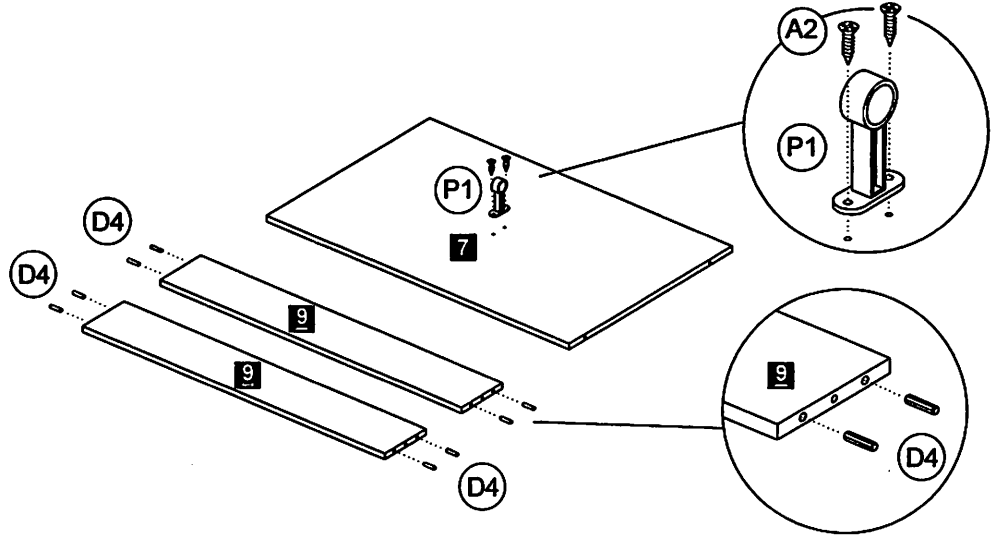

**STEP 3** Use Allen Key (N1) to tighten the Crosshead Screw (A17) & button the screw head with Crosshead Cover (Y). Insert the Hanging Steel Pipe (P) through the pipe holder until large marking hole at panel no. 2.

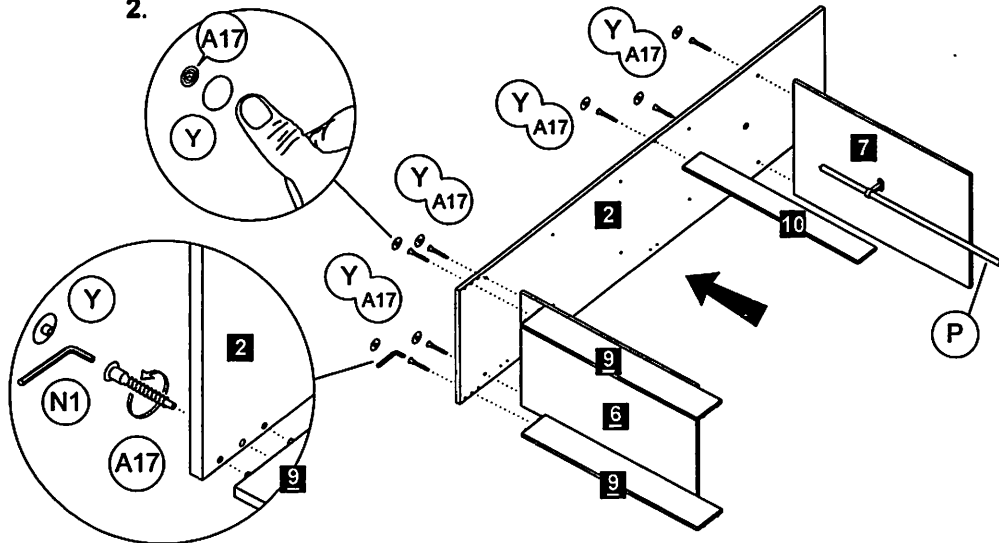

**STEP 4** Use Allen Key (N1) to tighten the Crosshead Screw (A17) & button the screw head with Crosshead Cover (Y).

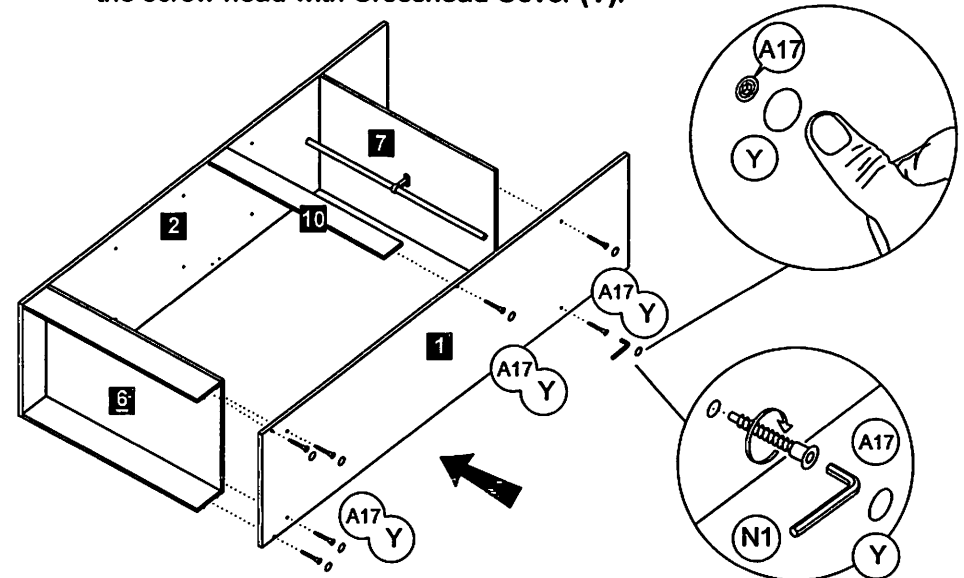

**STEP 5** Attach the panel no. 5 in right position. Use Allen Key (N1) to tighten the Crosshead Screw (A18). Screw the L Bracket (R1) at between panel no. 6 & 9.

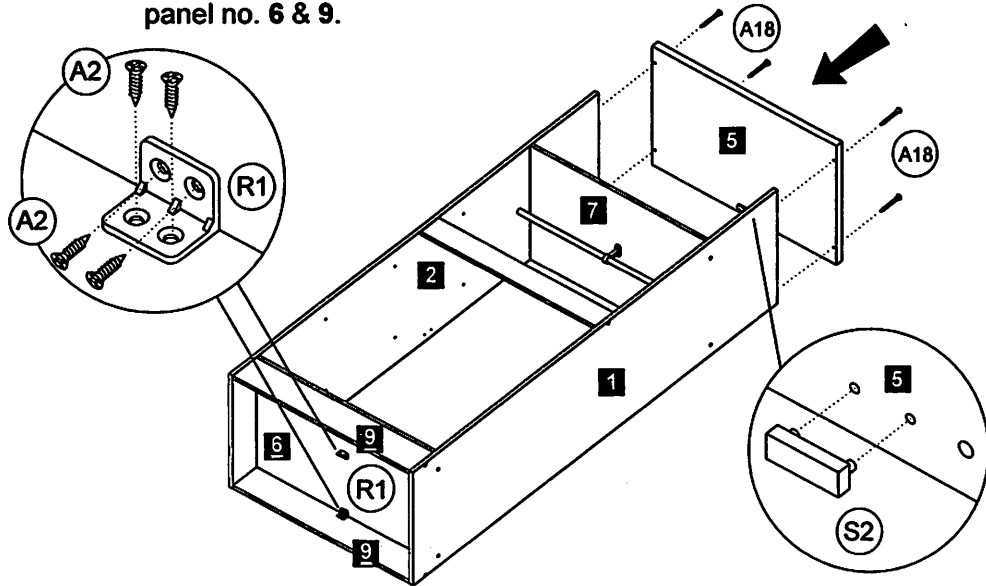

**STEP 6** Use Screw (A2) to assemble the Plastic Leg L Shape (L2) at between panel no. 9 & side panels. Assemble the back panel no. 11 with secure by Nail (N3). Panel no. 6 & 10 secure by Screw (A2).

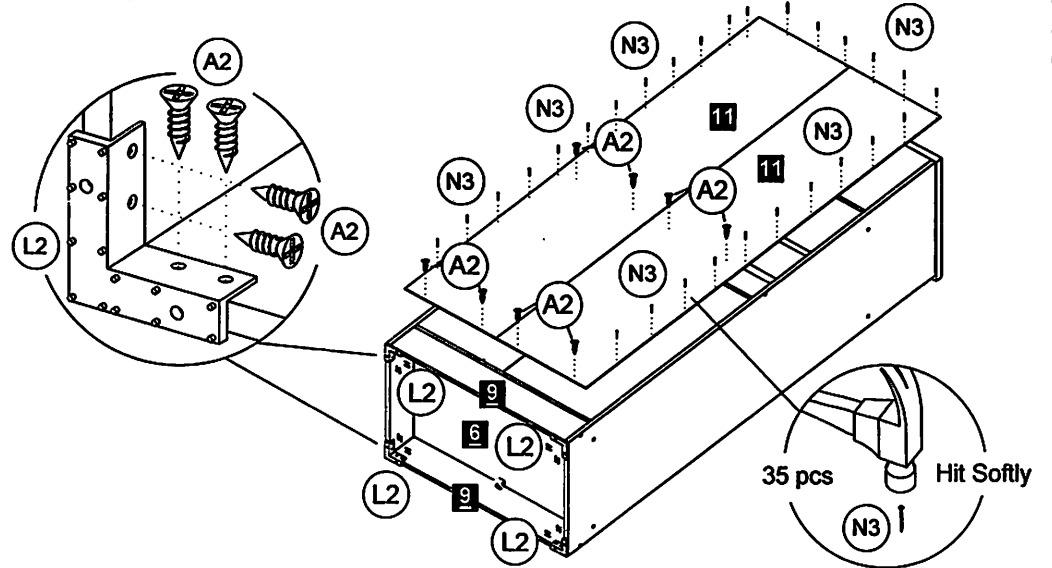

**STEP 7** Insert the Plastic Shelf Support With Steel Pin (Q4) at panel 1 & 2. Use Screw (A4) to assemble Square Lock Set (C5) at panel no. 4. Attach the Door Hinges (E5) at panels no. 3 & 4 to side panels then adjust the hinges screw to ensure the parallel of door gaps.

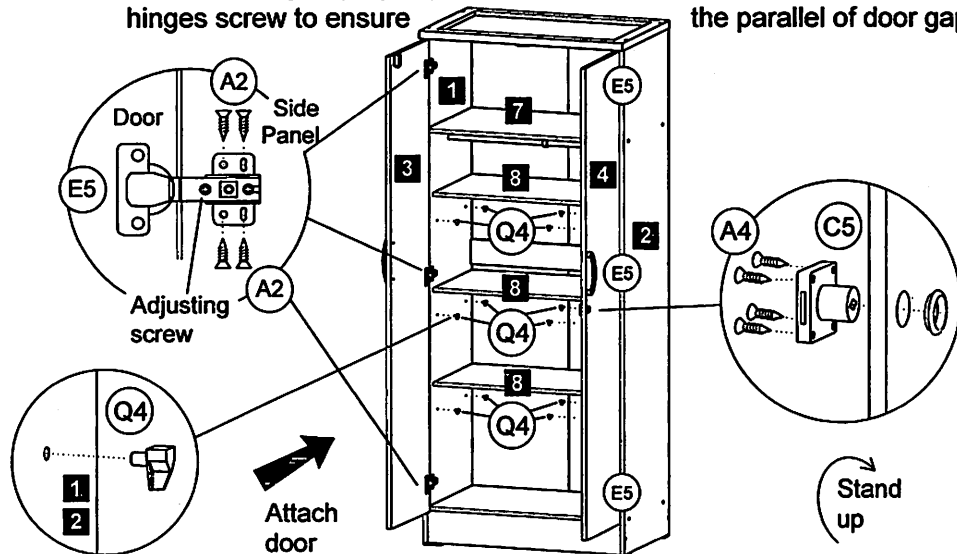

**COMPLETE**

