

Assembly Manual

OFFICE CHAIR



Please read this manual carefully before use and keep it for future reference.

Matters Needed Attention for Chair

Thank you for the recent purchase of our product. We hope you will be pleased with both the product and service you received.

If not, please give our helpful customer service team an opportunity to improve your experience right away.

- The parts are missing/damaged in transportation, contact us to get replacement part.
- The screws can not insert or the slots for the screw is stripped, contact us to get help.

3. Usage Troubleshoot

- Adjust the height of the chair to suit your height. If it is not suitable for you, please contact us for help.
- If the chair is tilted to one side or forward, make sure the screws on the seat plate are tightened, make sure the chassis is not mounted upside down, and contact us if the problem cannot be resolved.
- If the fabric of the chair is torn or stained when you receive it, please contact us to get the replacement part or compensation.
- If the chassis is broken, please contact us for a replacement or partial refund, please contact us for help.
- If part is missing, please contact us and provide the picture of the missing part, we will replace it











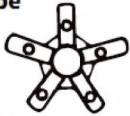



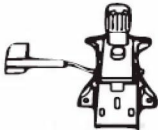



4. Return Request

If you are not 100% satisfied with the chair, please give us a chance to help you solve all your problems with our products.

And we also need your suggestions to improve the quality of the chairs to avoid the same problems happening again, this is the most important thing we can do as a new brand.



Accessories List

<p>(A) Central Base Tube</p> 	<p>(B) Split Base Tube ×5</p> 	<p>(C) Castor ×5</p> 	<p>(D) Air Rod</p> 
<p>(E) Base Plate</p> 	<p>(F) Armrest Frame</p> 	<p>(G) Armrest Pad</p> 	<p>(H) Seat Cushion</p> 
<p>(I) Backrest</p> 	<p>(J) Steel Plate</p> 	<p>(K) Footrest</p> 	<p>(L) Metal Foot Bracket</p> 
<p>(M) Screws M6×20mm × 5</p> 	<p>(N) Screws M6×20mm × 4</p> 	<p>(O) Screws M6×25mm ×10</p> 	<p>(P) Screws M6×30mm ×10</p> 
<p>(Q) Screws M8×25mm ×3</p> 	<p>(R) Hexagon Wrench</p> 	<p>(S) Plastic Fixing Tube</p> 	<p>(T) Screws M5×10mm ×1</p> 

STEP 1

Insert Split Base Tube into Central Base Tube

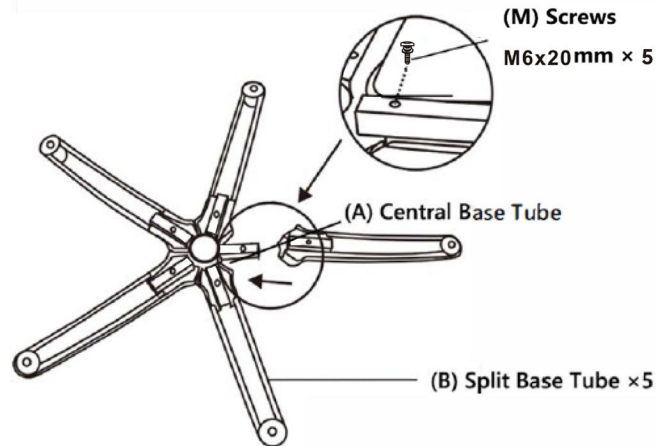

STEP 2

Insert Castors and Air Rod into parts done in Step 1

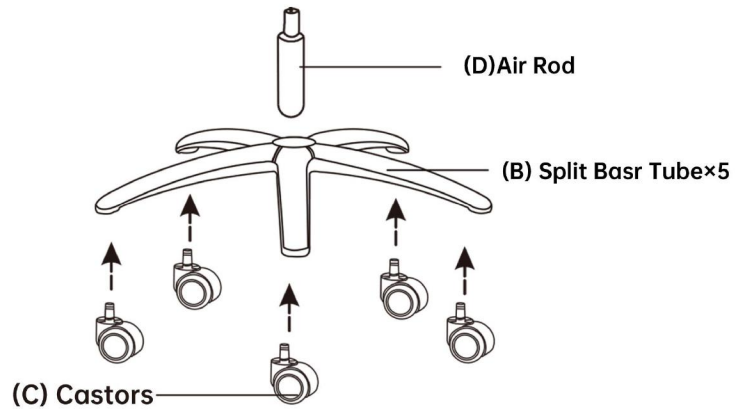

Assembly Instruction

STEP 3

Attach Metal Foot Bracket on the Seat Cushion



Before installing the screw (T), insert the metal tube into the plastic fixing tube first.

STEP 4

Install handrests, base and steel plates.

Assemble the handrest first.

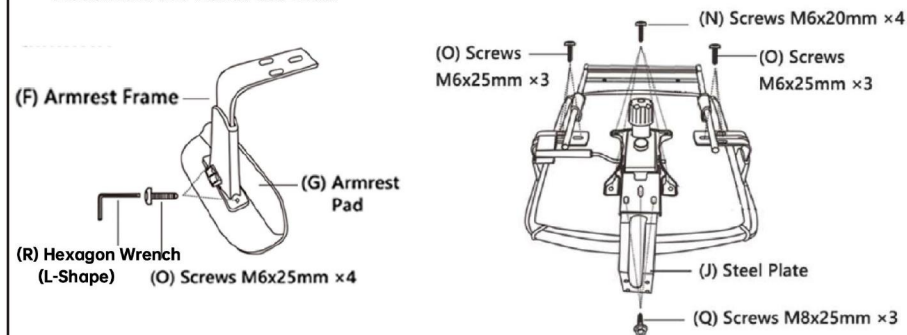

Placing the seat cushion on the outer box makes assembly easier.

STEP 5

Install the backrest

It is recommended that two people work together to install it.

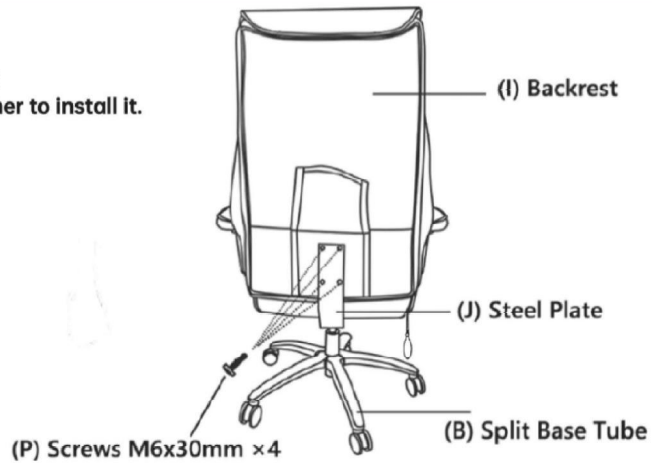

STEP 6

Install the footrest

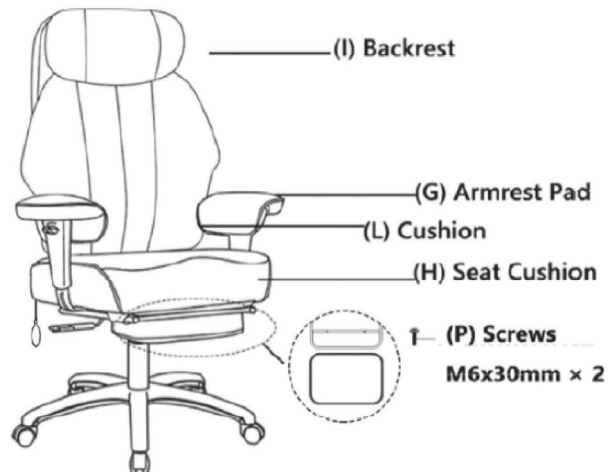

Matters Needed Attention for Chair

Thank you for the recent purchase of our product. We hope you will be pleased with both the product and service you received.

If not, please give our helpful customer service team an opportunity to improve your experience right away.

1. Installation Troubleshoot

- The parts are missing/damaged in transportation, contact us to get replacement part.
- The screws can not insert or the slots for the screw is stripped, contact us to get help.

Chair Safety Warnings

1. General Safety Warnings

- "This chair is designed for office or home use only. Do not use it for industrial, medical, or other unintended purposes."
 -
-

2. Assembly Warnings

- "Follow the assembly instructions precisely. Incorrect assembly may lead to instability or collapse."
 - "Ensure all screws and bolts are fully tightened before use. Check periodically for looseness."
-

3. Usage Warnings

- "Do not stand on the chair or use it as a step ladder. The chair is not designed to support dynamic loads."
 - "Avoid leaning back excessively or rocking the chair violently, as this may cause tipping."
-

4. Adjustment Warnings

- "Adjust the seat height so your feet rest flat on the floor. Improper adjustment may cause posture-related injuries."
-

5. Maintenance Warnings

- "Use only mild cleaners. Harsh chemicals may damage materials or weaken structural integrity."
 - "Inspect the chair regularly for wear and tear (e.g., gas
-