

## 3x5 Storage Shed Installation

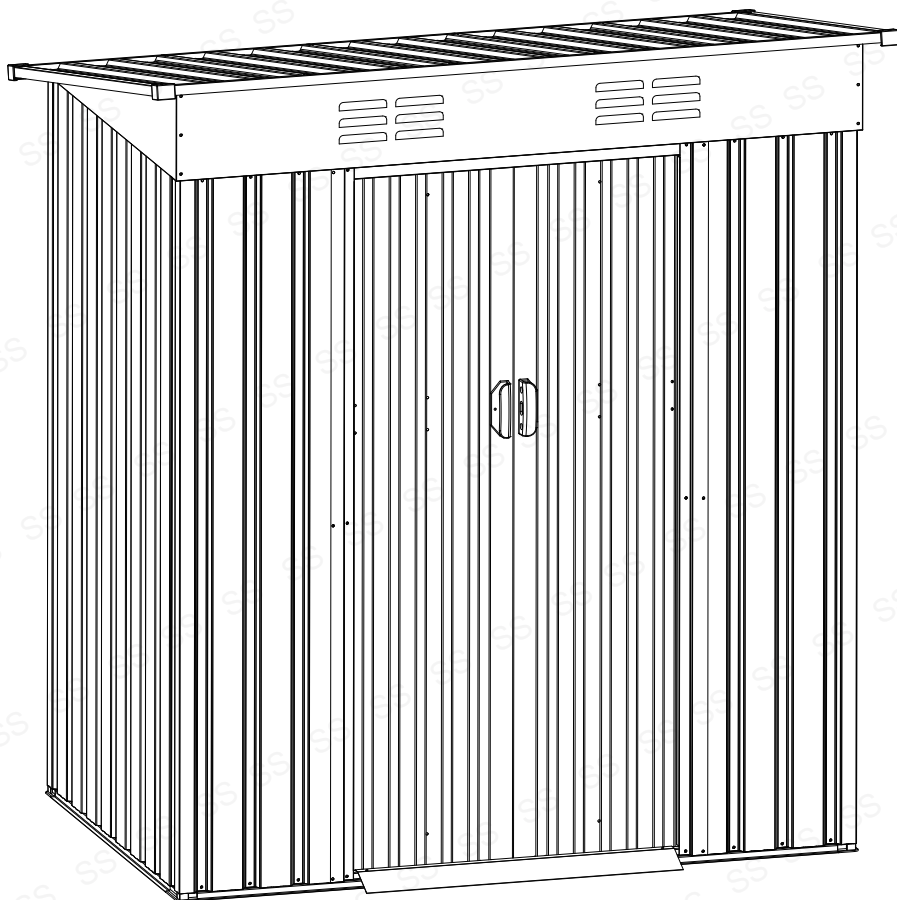

The product comes in one packages.  
Please install after receiving all package.

## Please prepare below tools before installation.(Not Included)

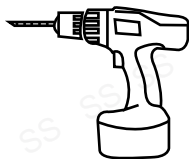

Electric Screwdriver

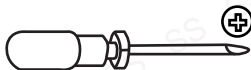

+ Manual Screwdriver



Ladder

### Package included Tools



Gloves x 1 Pair



Screwdriver x 1

## ATTENTION:

Please read this instruction carefully before installation and follow it strictly during installation. Ensure that there are no problems later due to installation errors.

## Installation Notes

Please check the quantity of all parts before installation (Please refer to the Parts Lists) and the appearance of the products. Please make sure the product is correct before installation. If there is any problem, please contact us directly.

Make sure the colored panels are facing outwards and all the holes match. The panels are textured, please install the panels in the order specified in the instructions. All lines and holes must be accurately matched to make the storage shed more stable. Please ensure that all screws are tightened to prevent the product from falling apart.

There is a protective film on the surface to protect the product, please tear it off after installation to get the final presentation. If you do not damage the film during installation, it can also remain on the product to protect the product.

Please place the product on a flat ground to prevent leaning and collapse. If the ground is uneven, the door may can't be closed.

## Safety Precautions

We recommend two adults to complete the installation. Two adults installed together will make the installation process easier and safer.

The gloves must be carried to prevent hand cuts during installation.















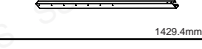

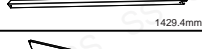

Take care when using power tools near water the use of a residual current device(RCD) is advised.



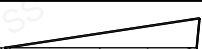







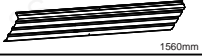







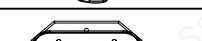

Please use the electric driver carefully during screwing to prevent the screw from slipping and hurting your hand. (We recommend that beginners use a manual screwdriver for installation.)

Be careful not to fall when installing the roof. Please steady the ladder and make sure the product placed on a flat ground.

**PLEASE KEEP THIS INSTRUCTION FOR FUTURE REFERENCE.**

# Part List

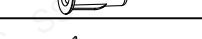
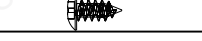
PART	NO.	QTY.
 1416.2mm	1	1
 838.4mm	2L	1
 838.4mm	2R	1
 1416.2mm	3	1
 1510mm	5	4
 1429.4mm	6	1
 894.4mm	7	2
 1429.4mm	8	1
 700mm	9	1
 700mm	15	2
 1560mm	17L	1
 1560mm	17R	1
 1625mm	19	2
 1103mm	20	2
 1103mm	21L	1
 1103mm	21R	1
 372mm	22	6
 770mm	23	1
 1560mm	W3	1
 1560mm	W5	5
 1560mm	W7	2

PART	NO.	QTY.
 1560mm	W8	2
 1095mm	W12	5
 1560mm	M1	1
 1560mm	M2	1
	A	1
	B	1
	C	2
	D	1
	E	1
	F	2
	F1	8
	F2	2
	F3	4
	F4	4
	F7	167
	F8	34
	S4	163
	S6	51
	S7	51
	S8	12
	S9	4

# Storage Shed Assembly Instruction

Shed top panels	
NO.	QTY.
9	1
19	2
20	2
F4	4
W12	4
21L	1
21R	1

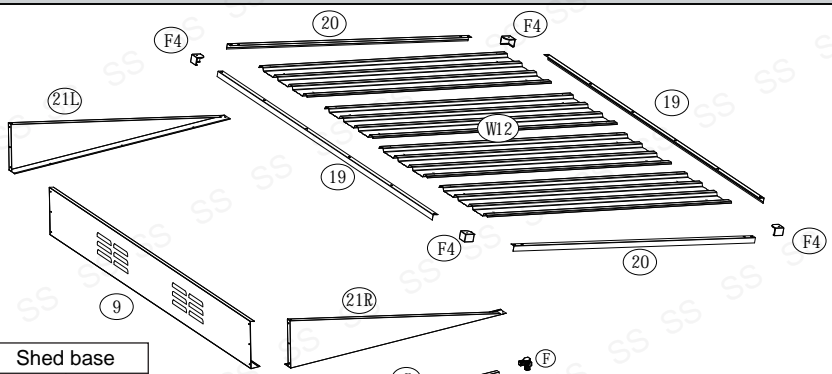

Shed base	
NO.	QTY.
2L	1
2R	1
3	1
5	4
7	2
8	1
W3	1
W5	5

Shed base	
NO.	QTY.
A	1
B	1
C	2
D	1
E	1
F	2
W7	2

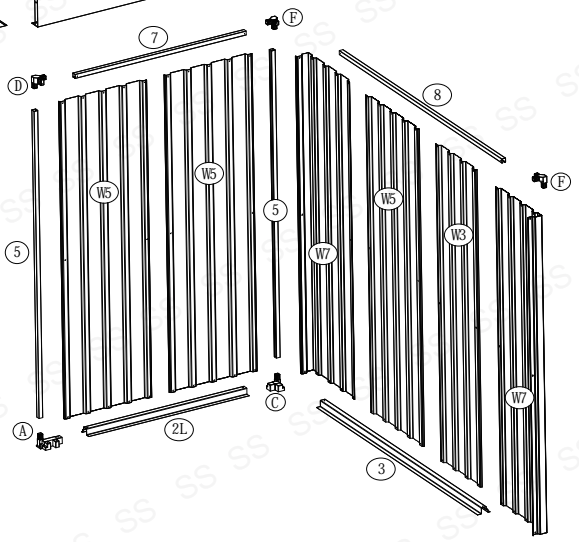

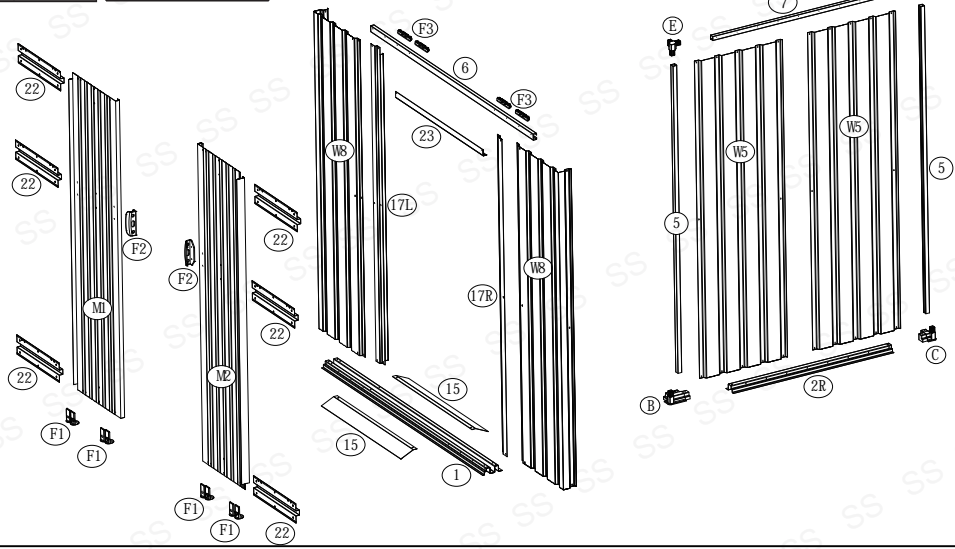

Door	
NO.	QTY.
1	1
6	1
15	1
17L	1
17R	1
22	6

Door	
NO.	QTY.
F1	8
F2	2
F3	4
M1	1
M2	1
W8	2





# Storage Shed Assembly Instruction

## STEP 1

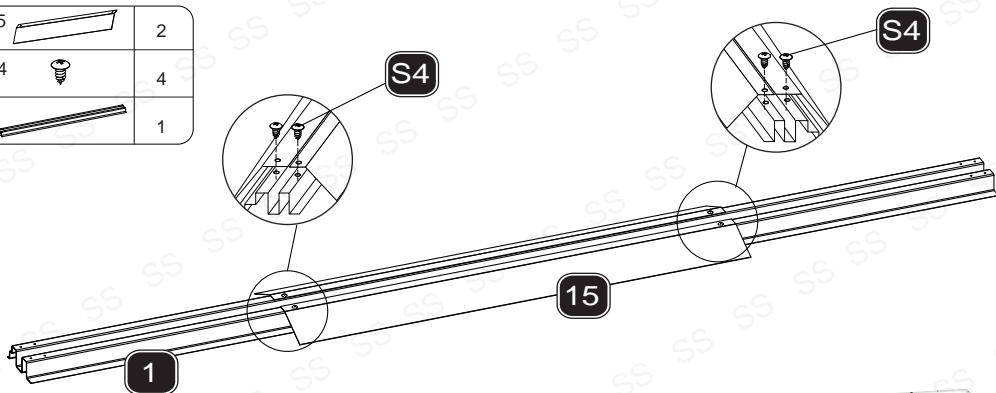
15		2
S4		4
1		1





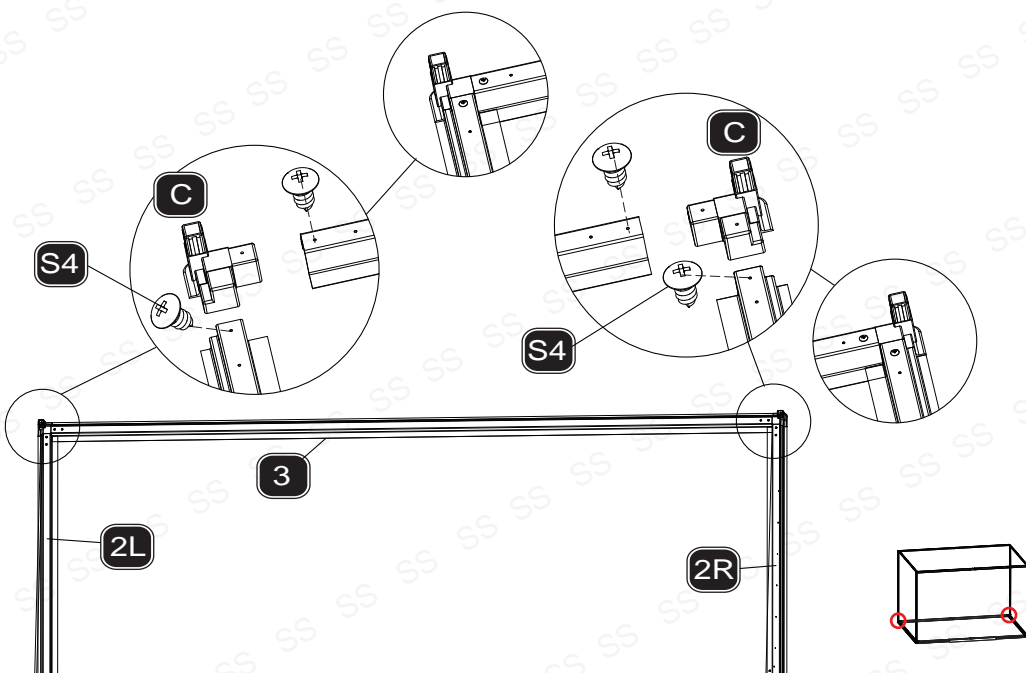

## STEP 2

C		2
S4		4

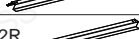

### STEP3

A		1
B		1
S4		4
2L		1
2R		1

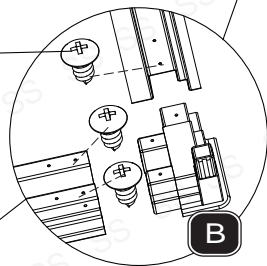
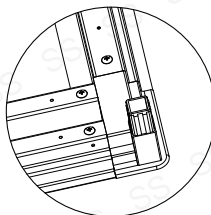
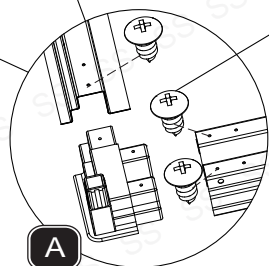
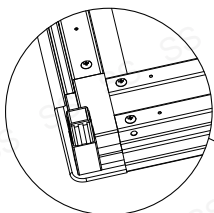
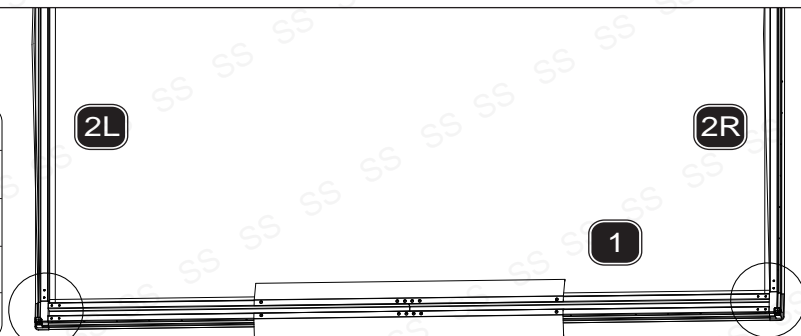

### STEP4

5		4
---	--	---

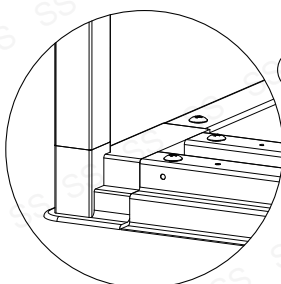
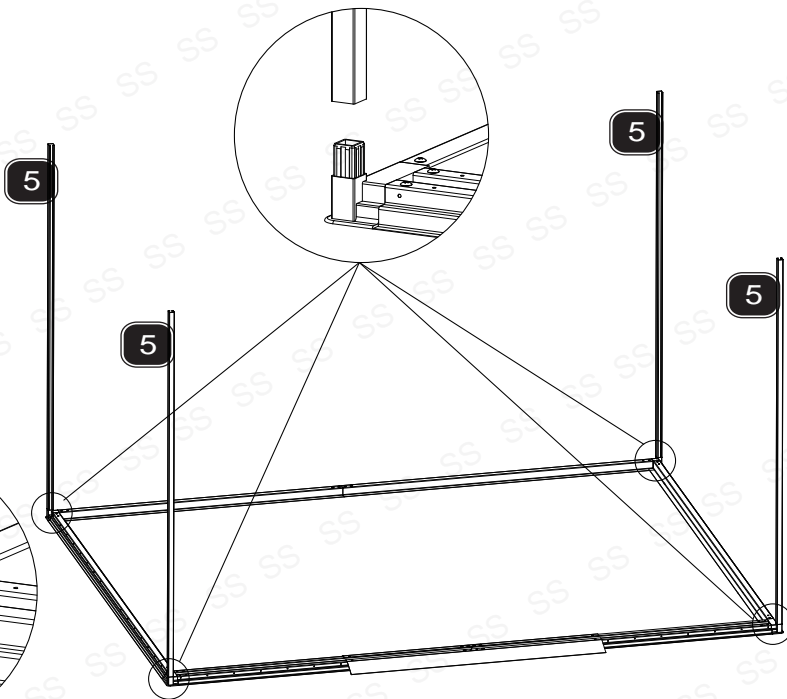

## STEP 5

6		1
F3		4

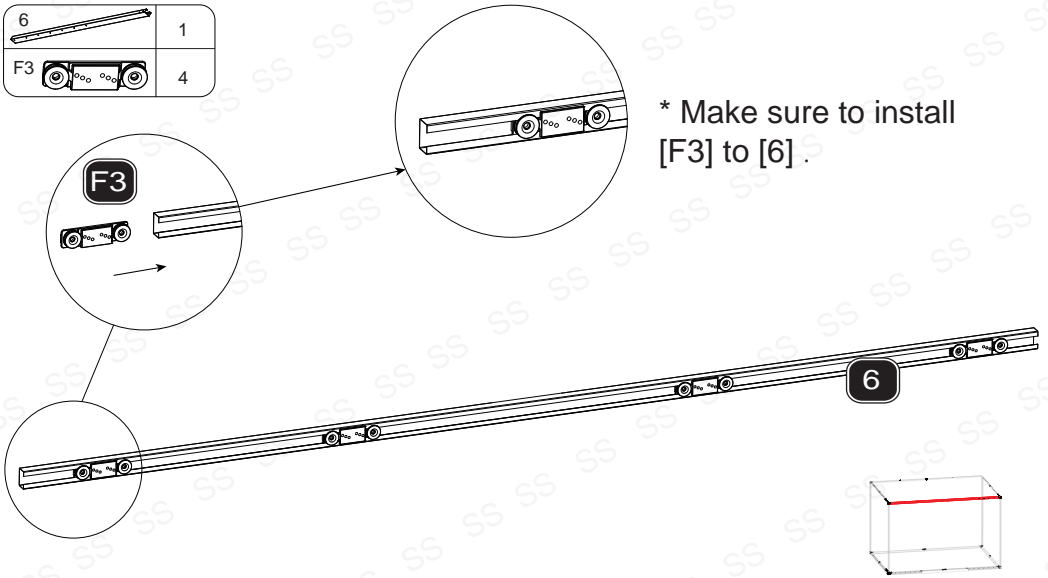

## STEP 6

D		1
E		1
F		2
S4		6

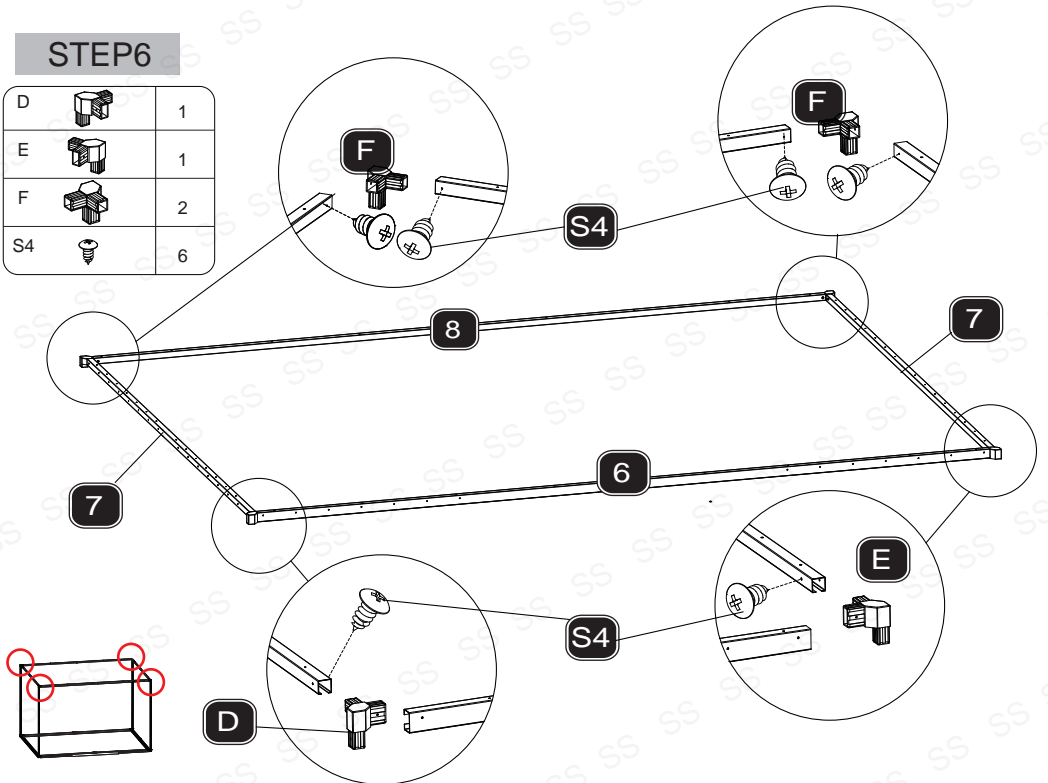

# STEP 7

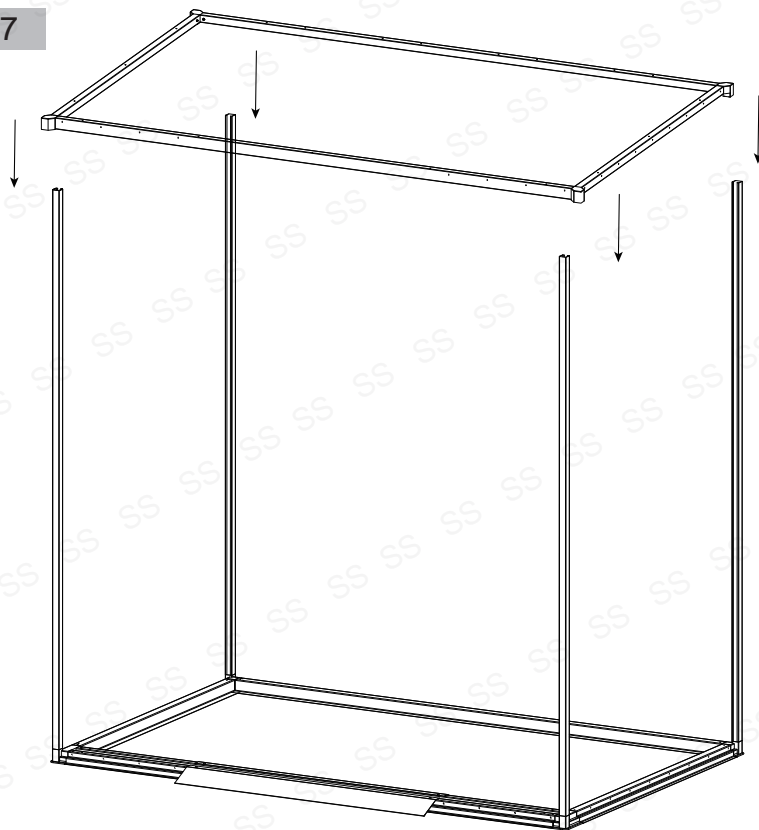

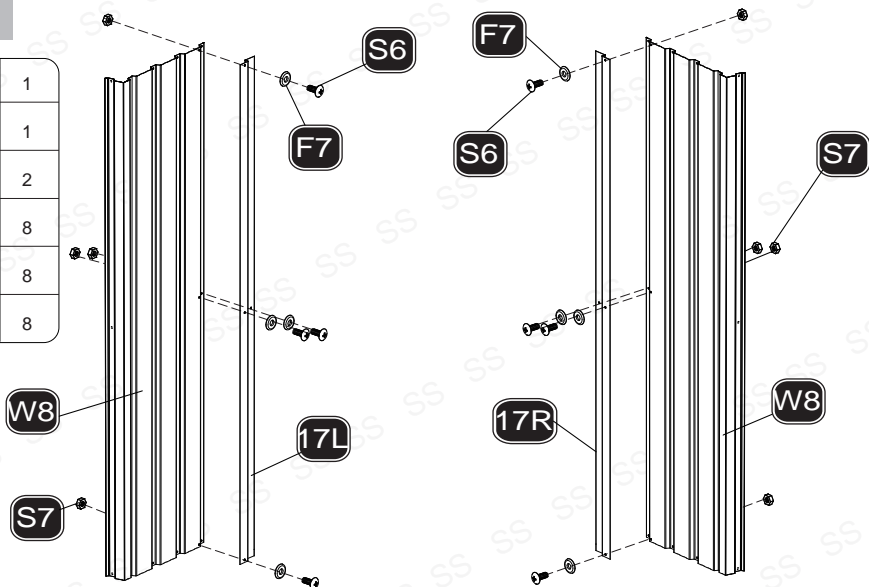

# STEP 8

17L		1
17R		1
W8		2
S6		8
S7		8
F7		8



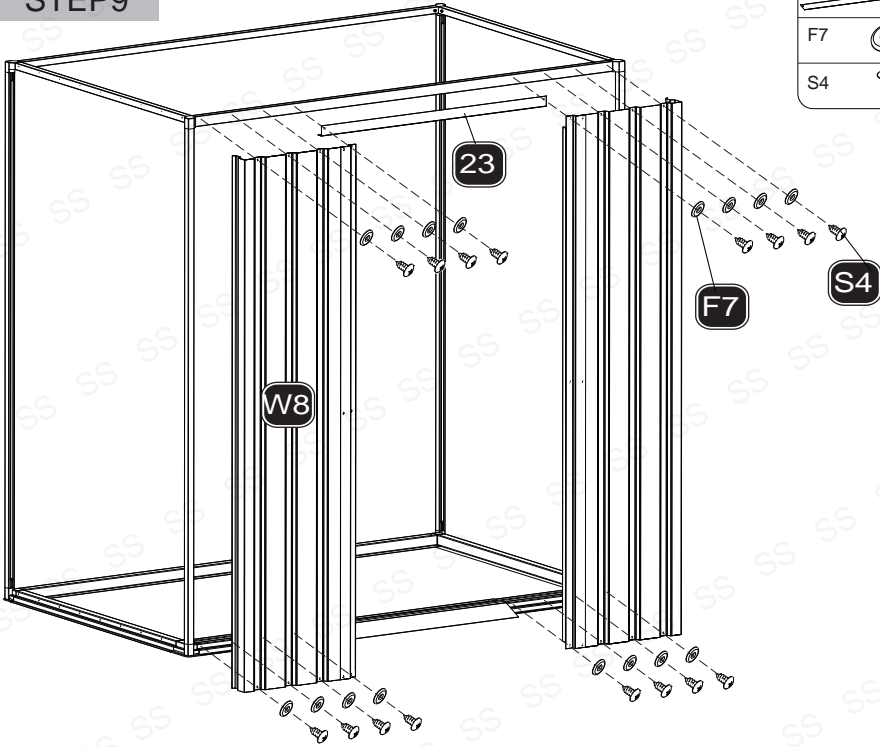

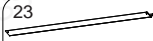



# STEP 9

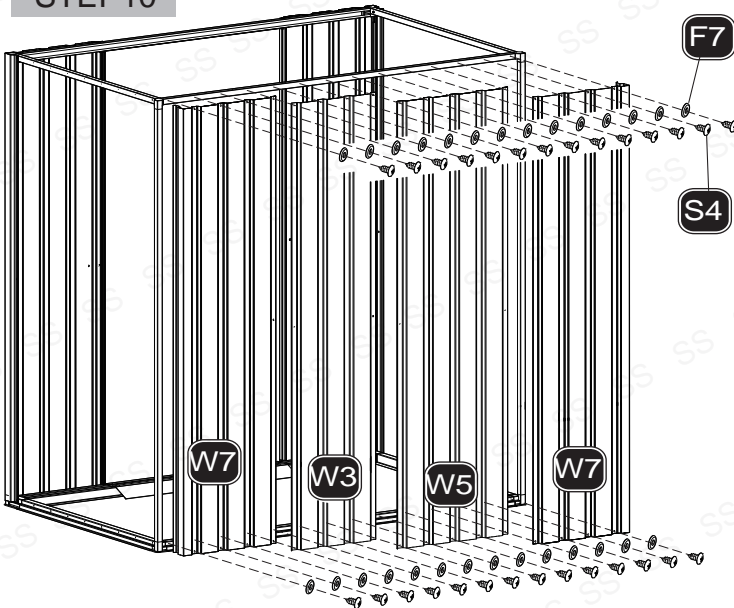

23		1
F7		16
S4		16



# STEP 10



W3		1
W5		1
W7		2
S4		28
F7		28

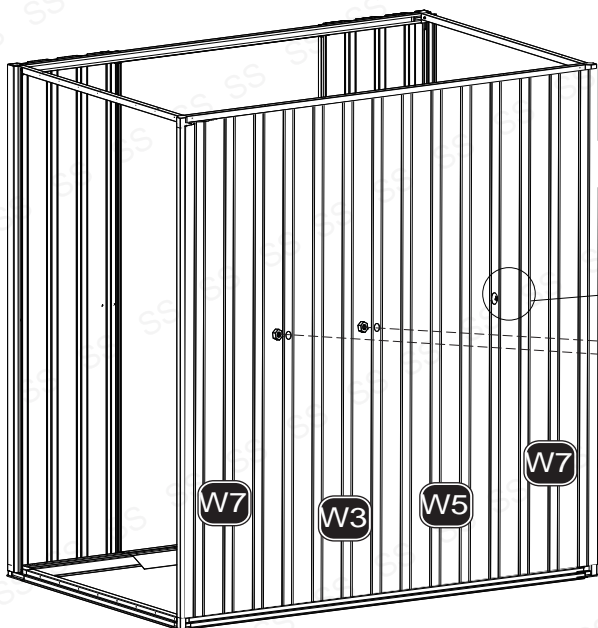



## STEP 11

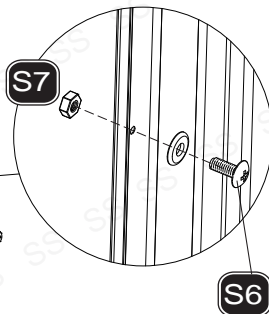

F7		3
S6		3
S7		3



## STEP 12

W5		2
S6		3
S7		3
S4		18
F7		21

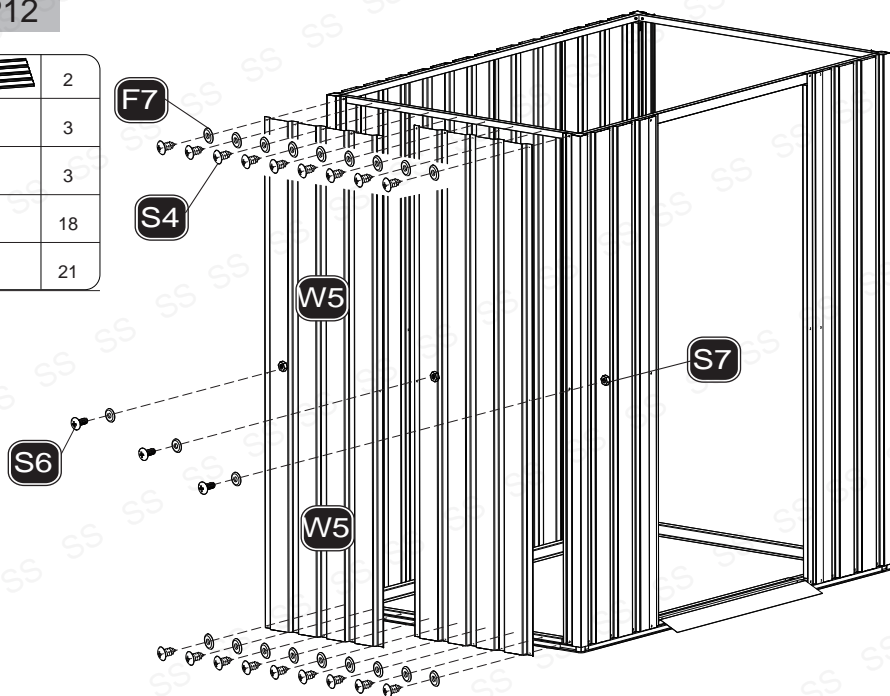



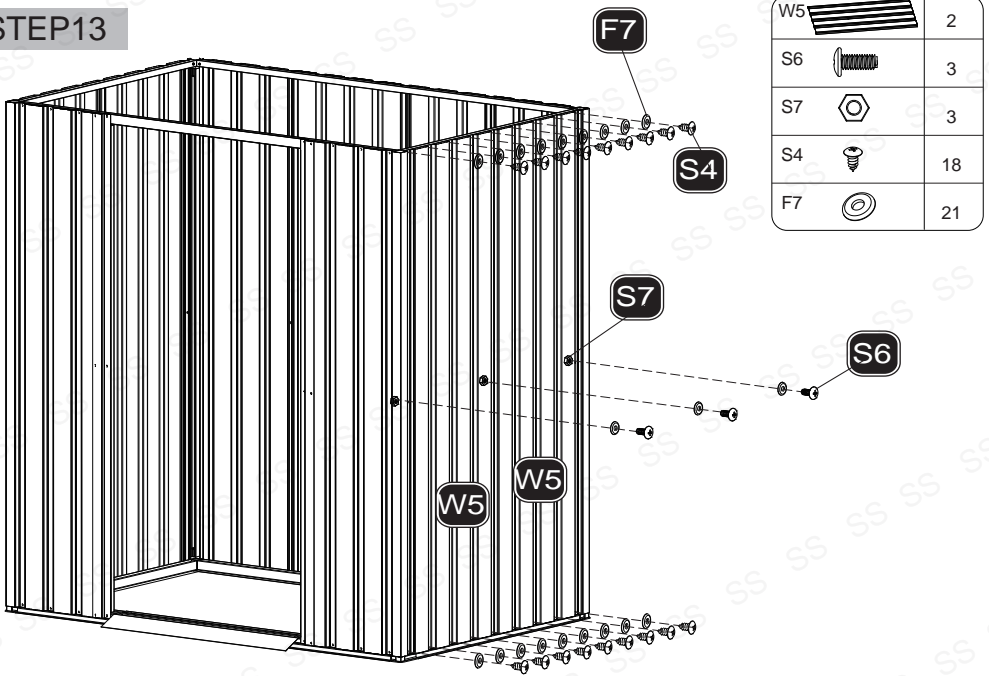

### STEP13

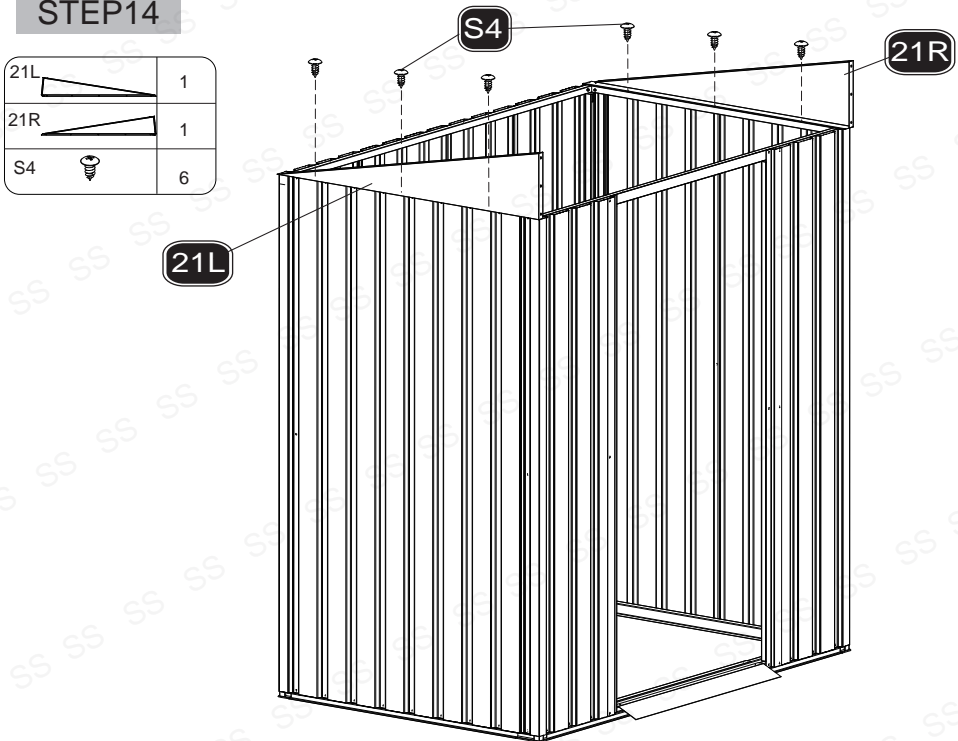

### STEP14



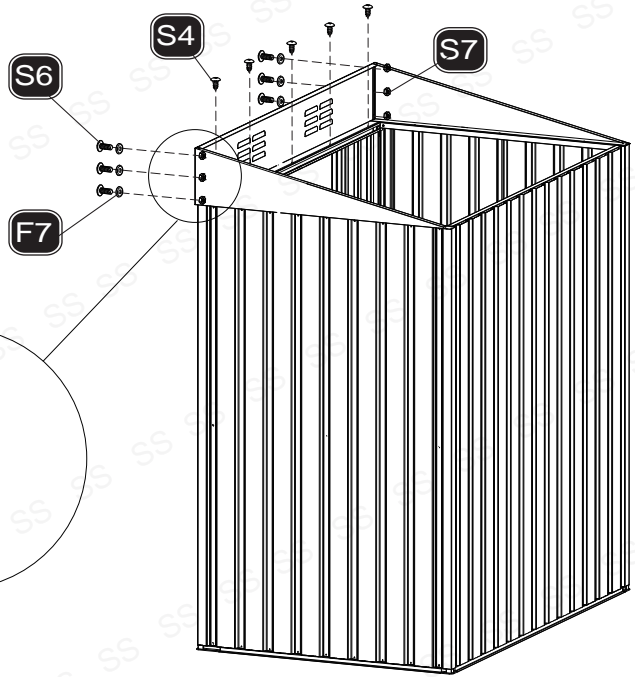
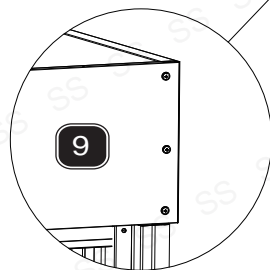

# STEP 15

9		1
S6		6
S7		6
S4		5
F7		6



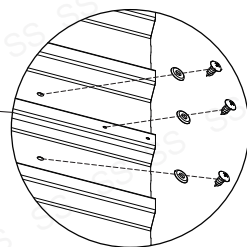
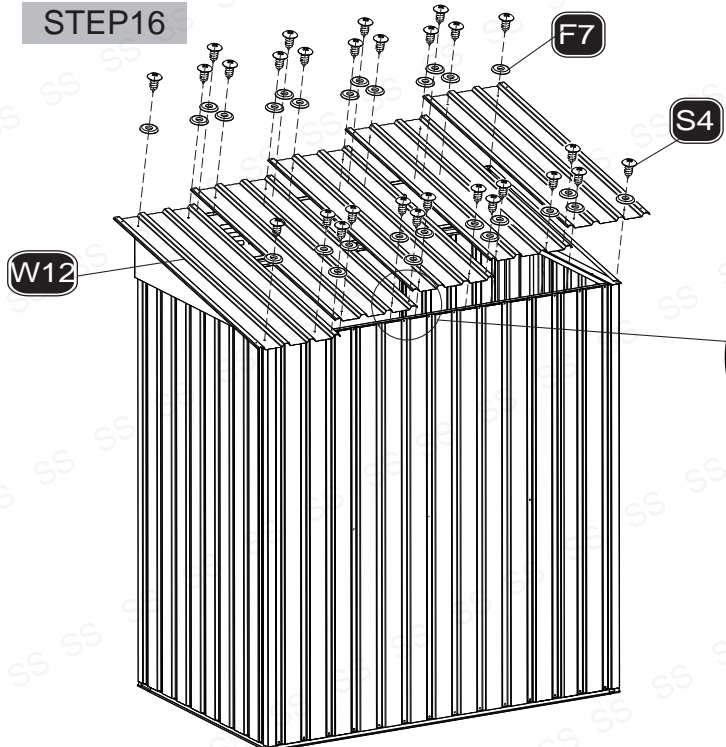

# STEP 16

W12		5
F7		28
S4		28





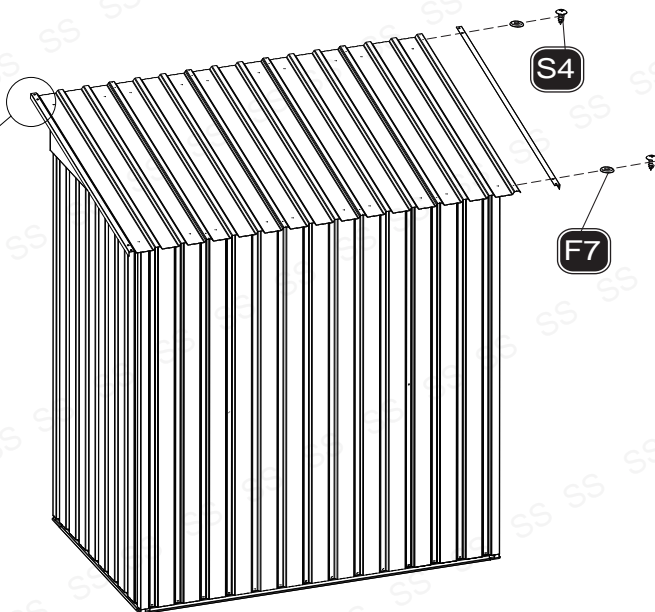
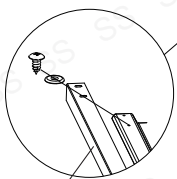

## STEP 17

20		2
F7		4
S4		4

20







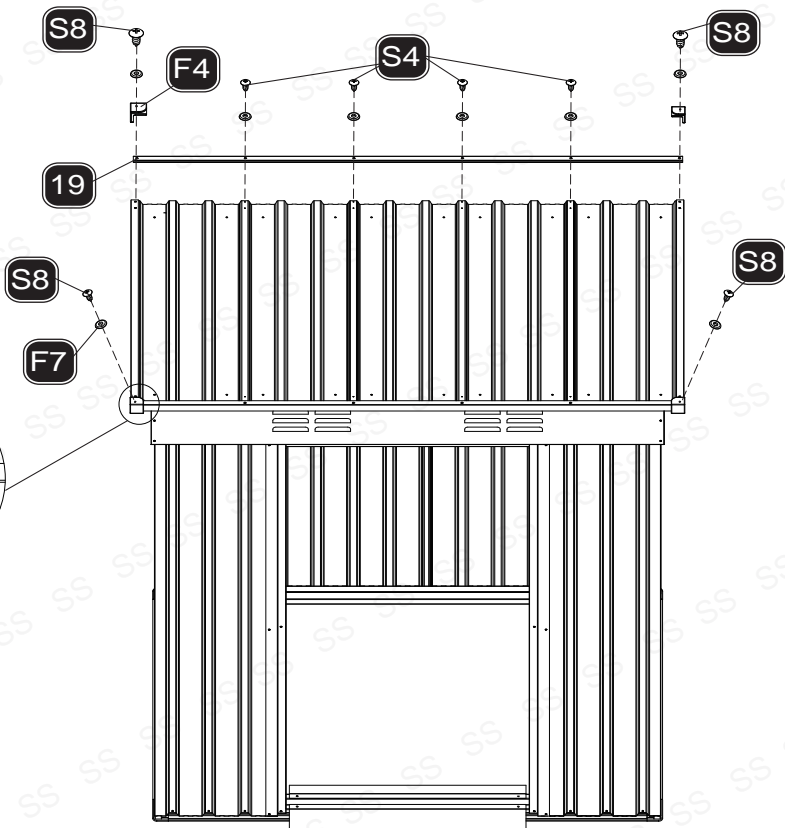
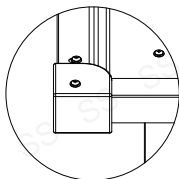

## STEP 18

19		2
F4		4
S4		8
F7		12
S8		4



## STEP19

M1		1
M2		1
22		6
F1		8
S6		24
S7		24
F7		24

\* Make sure to install [F1] to the door .

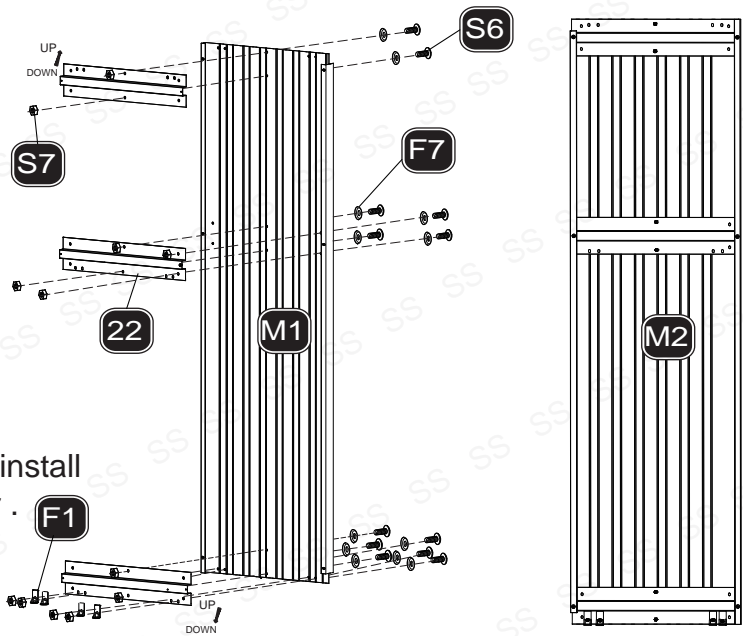

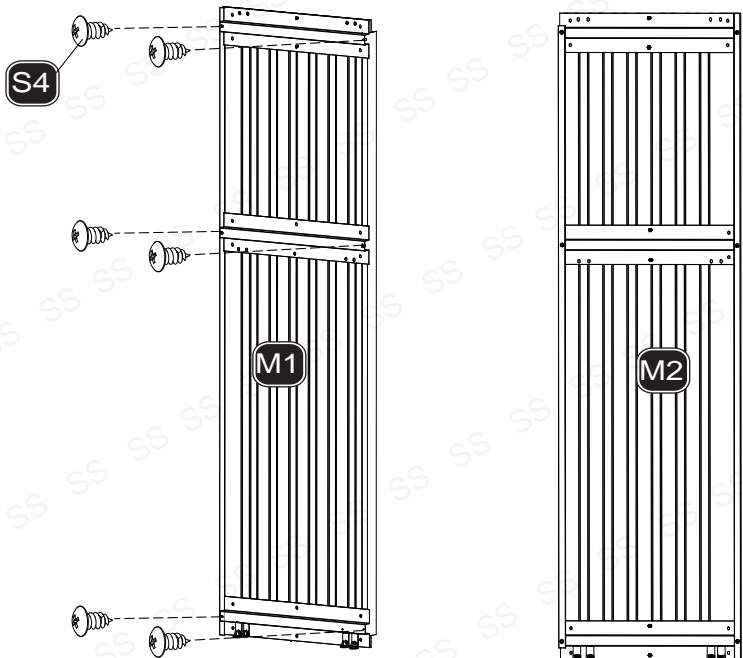

## STEP20

S4		6
----	---	---



## STEP21

F2		2
S6		8
S7		8

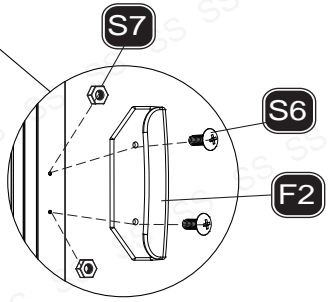
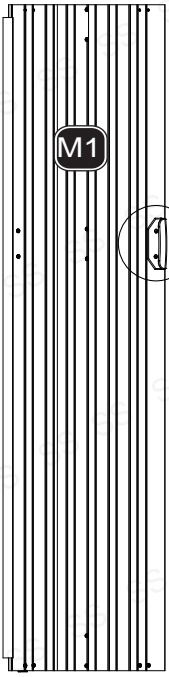

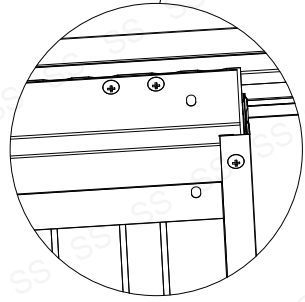
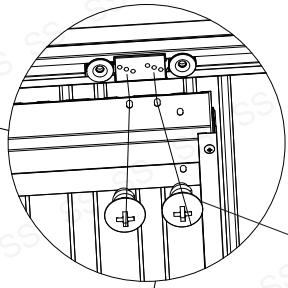
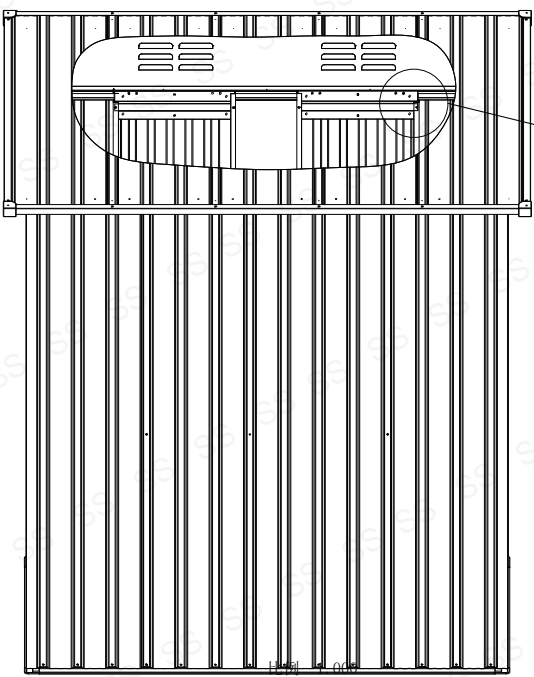

## STEP22

S8		8
----	---	---



## STEP23

F8		34
S9		4

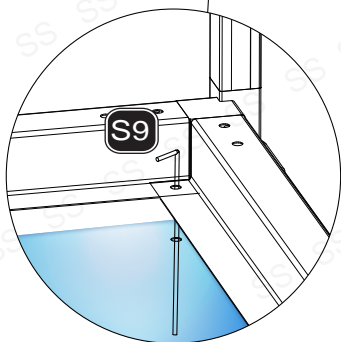
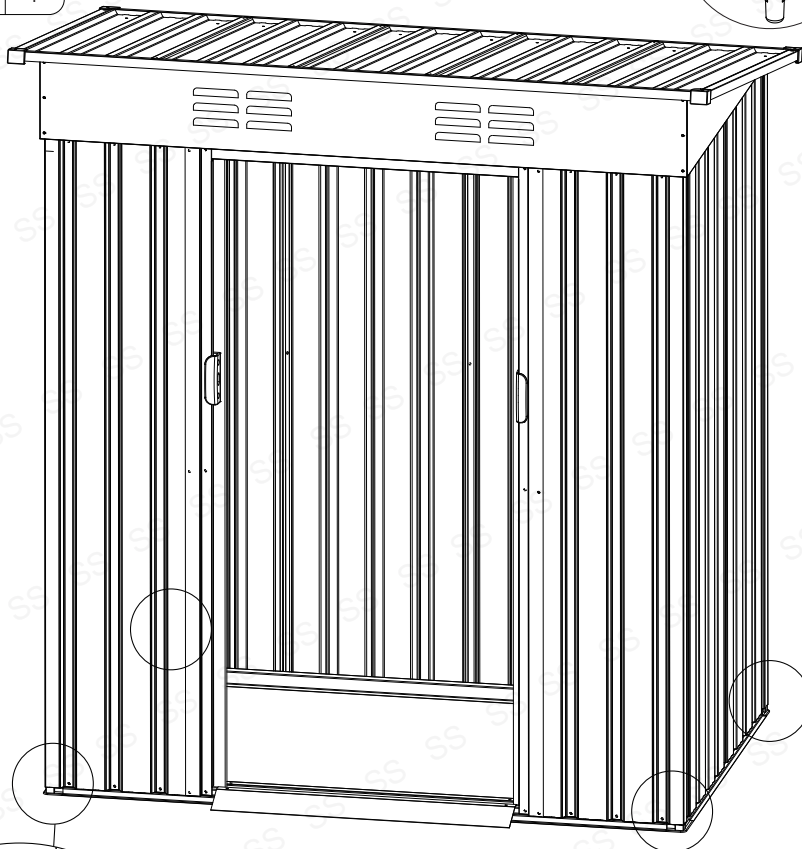
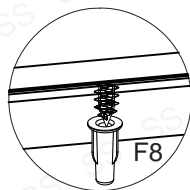

\*If the shed is installed on grass, the [S9] can be used to increase the stability of the shed.