

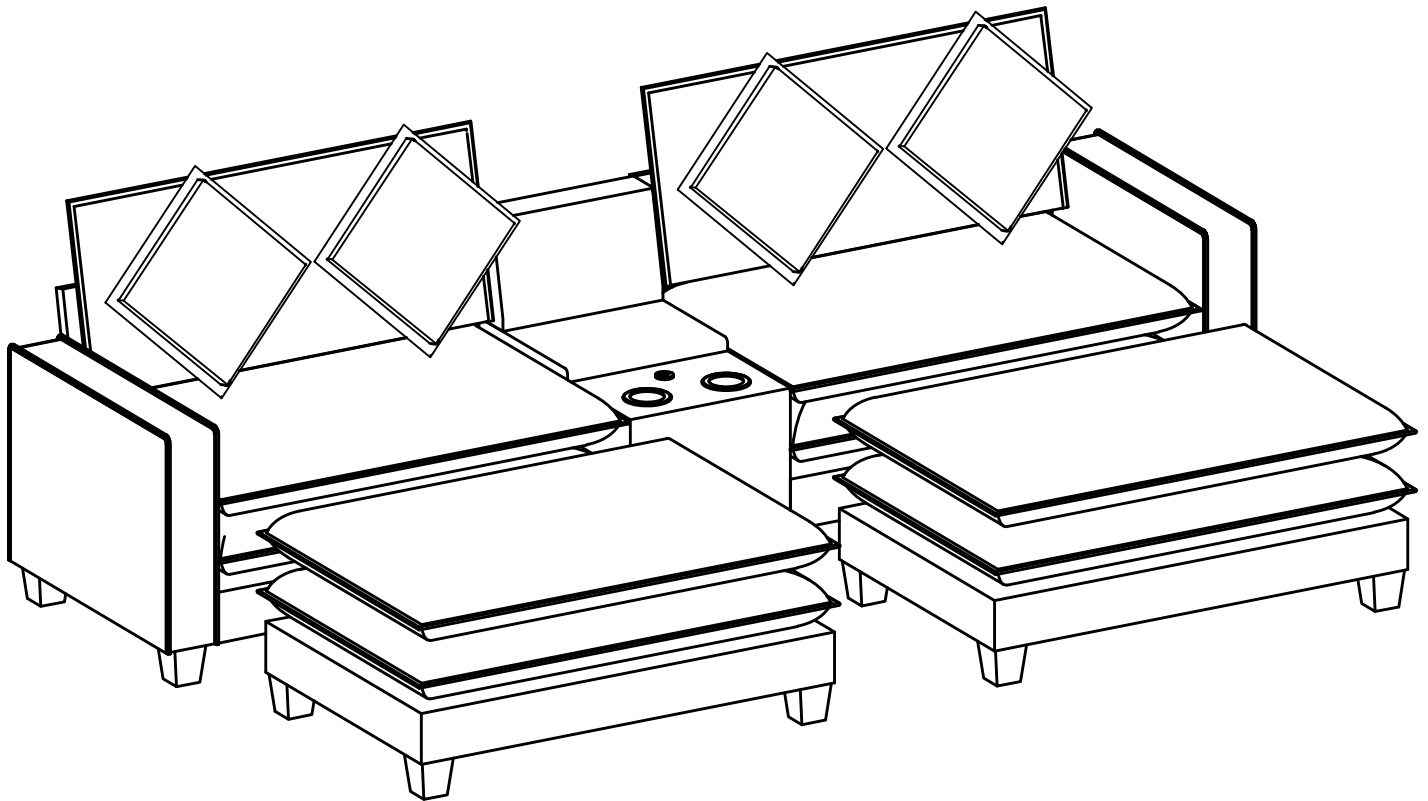

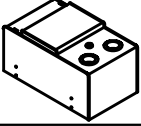





# ASSEMBLY INSTRUCTION

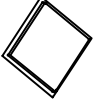

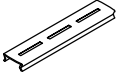
ITEM NO.: N719P411882 - N719P411883 -  
N719P411884 - N719P411885



**N719P411882 - COMPONENT LIST**

NO.	DRAWING	QTY	DESCRIPTION
(A)		1	Center Arm
(B)		1	Short Backrest
(C)		4	Pillows
(D)		16	Legs
HARDWARE		QTY	DESCRIPTION
(1)		2	Two-Headed Pads
(2)		1	Allen Wrench
(3)		24	Bolt 5/16 x 45mm
(4)		24	Flat Washer Ø8 5/16"

**N719P411883 - COMPONENT LIST**

NO.	DRAWING	QTY	DESCRIPTION
(E)		2	Arms
(F)		2	Backrests

**N719P411884 - COMPONENT LIST**

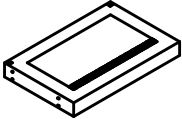
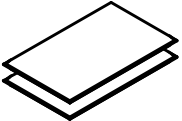
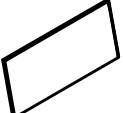
NO.	DRAWING	QTY	DESCRIPTION
(G)		2	Love Seat Frames
(H)		2	Seat Cushions
(I)		1	Back Cushion



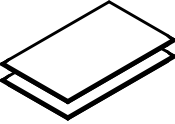
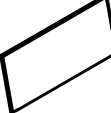
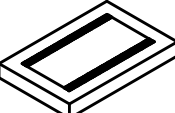

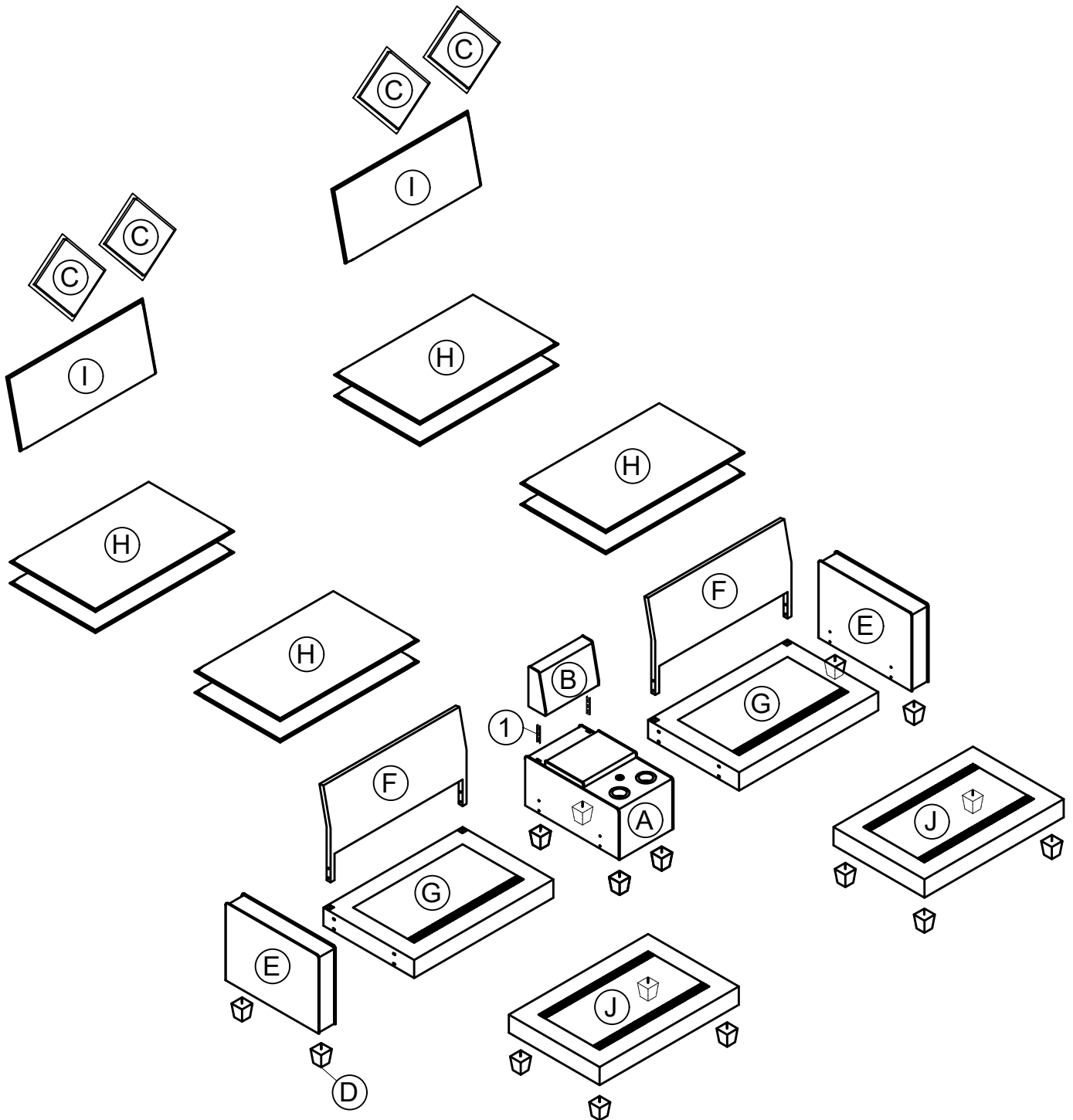

**N719P411885 - COMPONENT LIST**

Ⓜ		2	Seat Cushions
Ⓛ		1	Back Cushion
Ⓜ		2	Otoman Frames

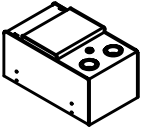

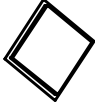

**PARTS LIST**

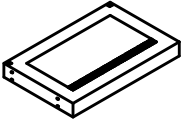
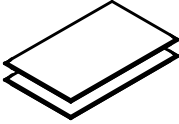
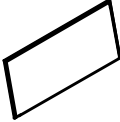
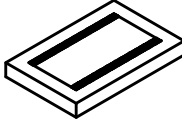

# PARTSLIST

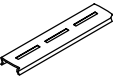
					
Center Arm x 1 pc	Short Backrest x 1 pc	Pillows x 4 pcs	Legs x 16 pcs	Arms x 2 pcs	Backrests x 2 pcs
					
Love Seat Frames x 2 pcs	Seat Cushions x 4 pcs	Back Cushions x 2 pcs	Otoman Frames x 2 pcs		

# HARDWARE

			
Two-headed pads x 2 pcs	Allen Wrench x 1 pc	Bolt 5/16" x 45mm x 24 pcs	Flat Washer Ø8 5/16" x 24 pcs

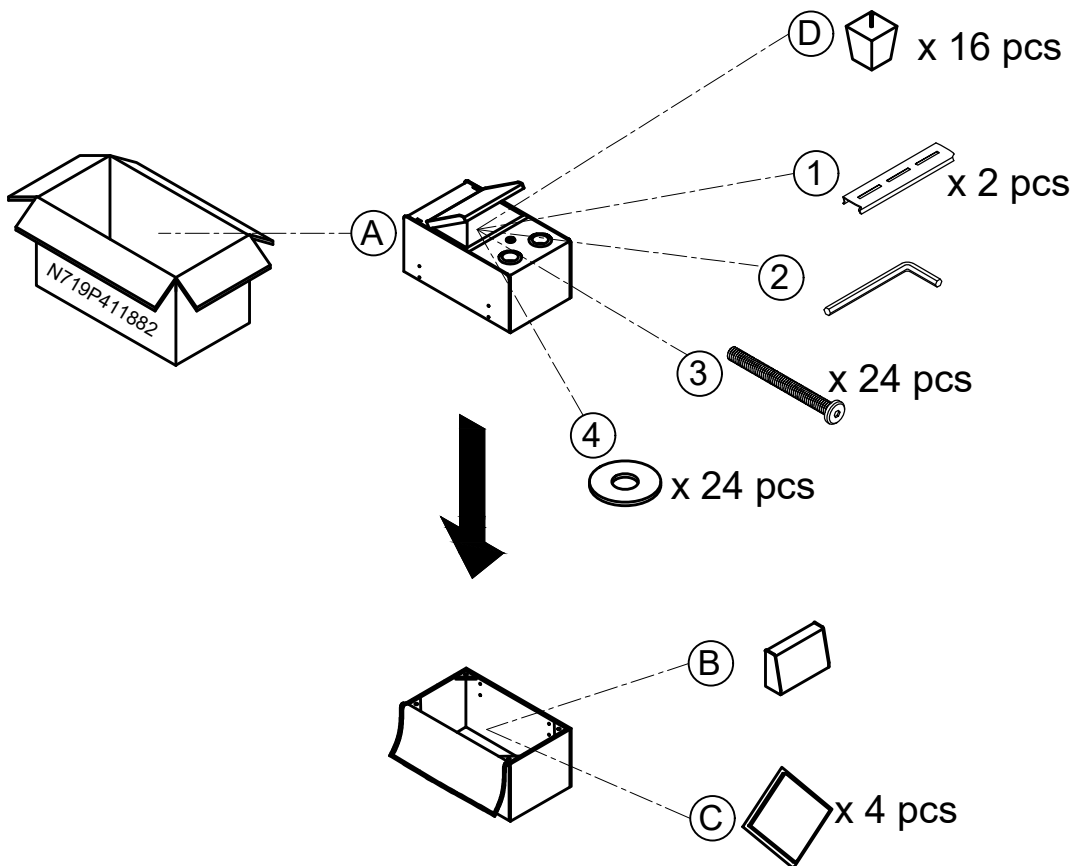

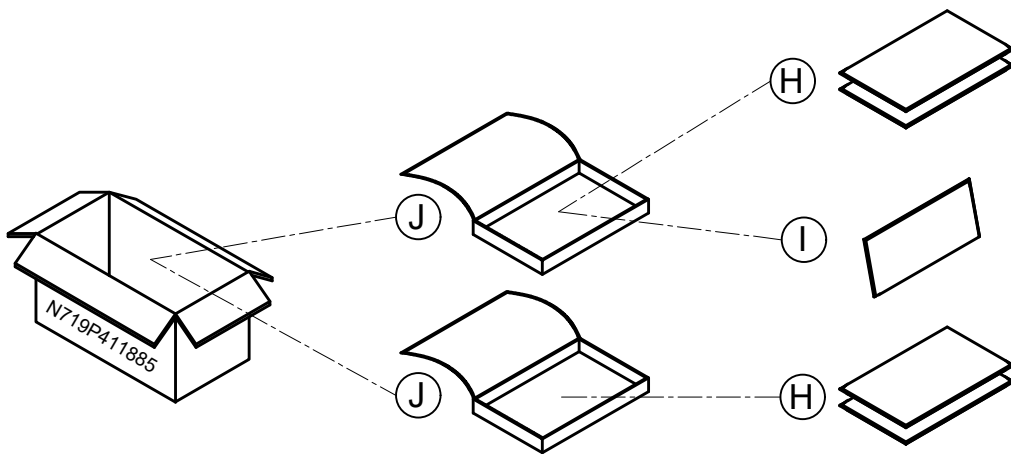
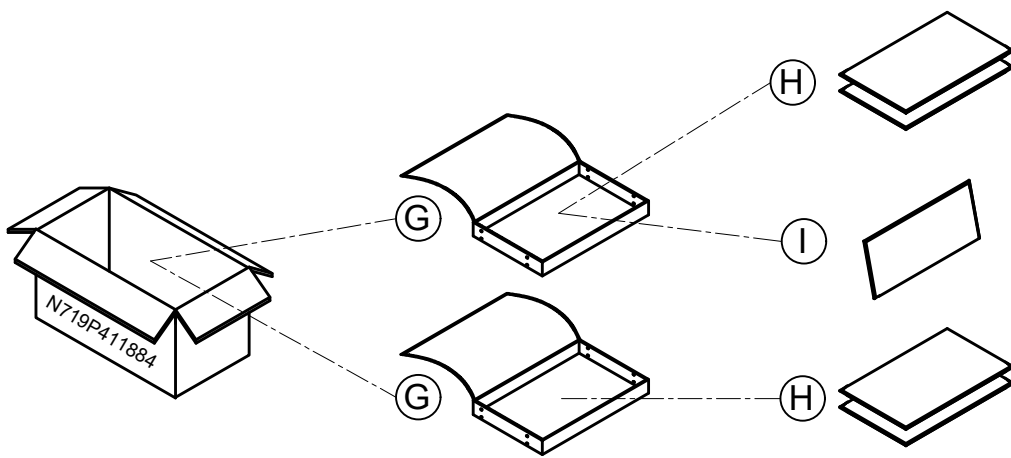
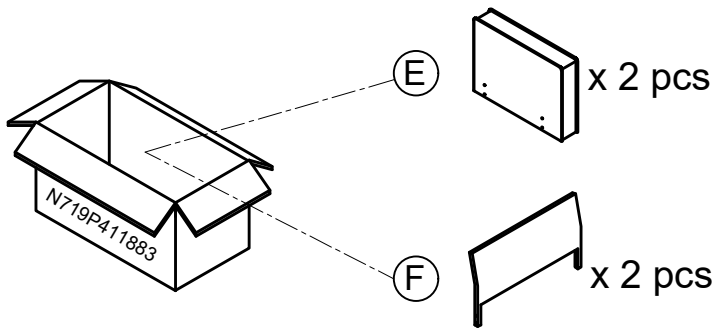

**STEP 1:**

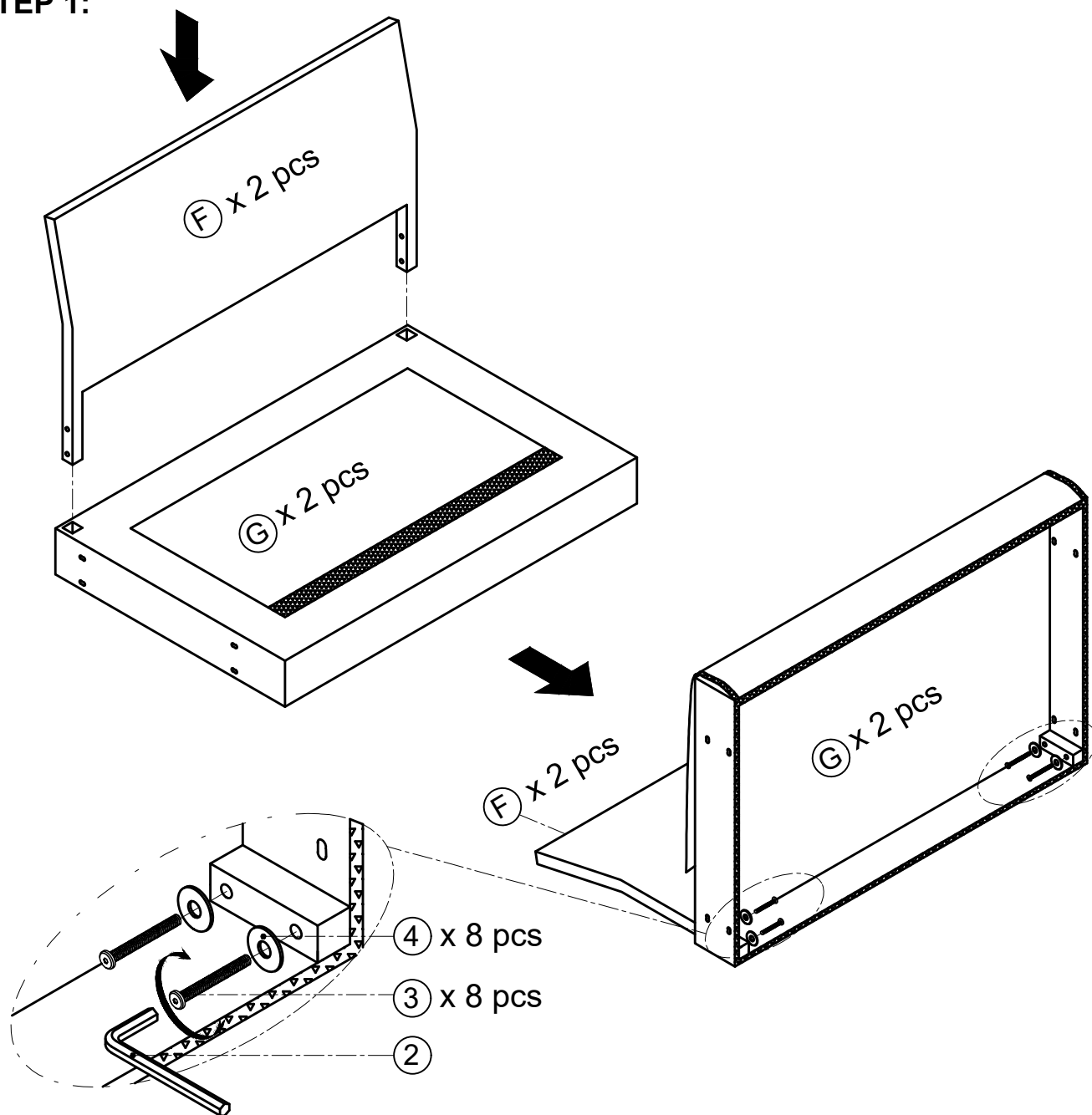

**STEP 2:**

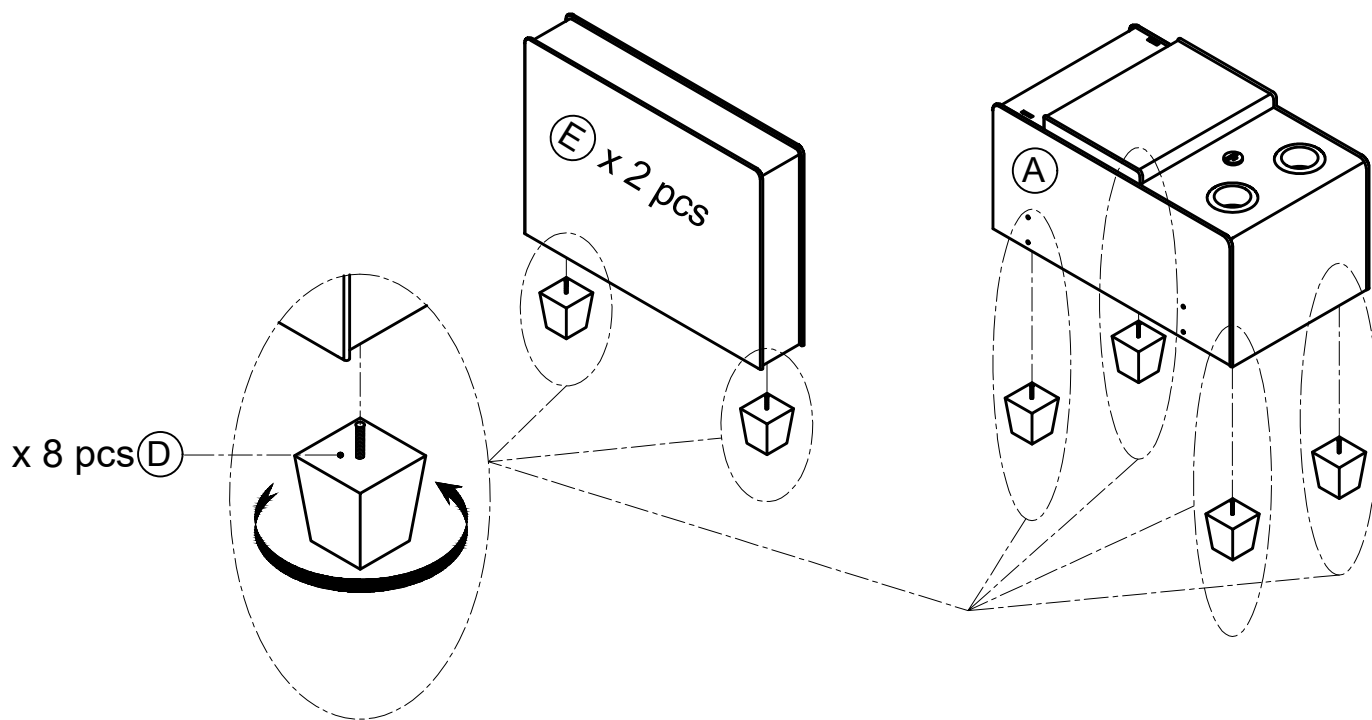

STEP 3:

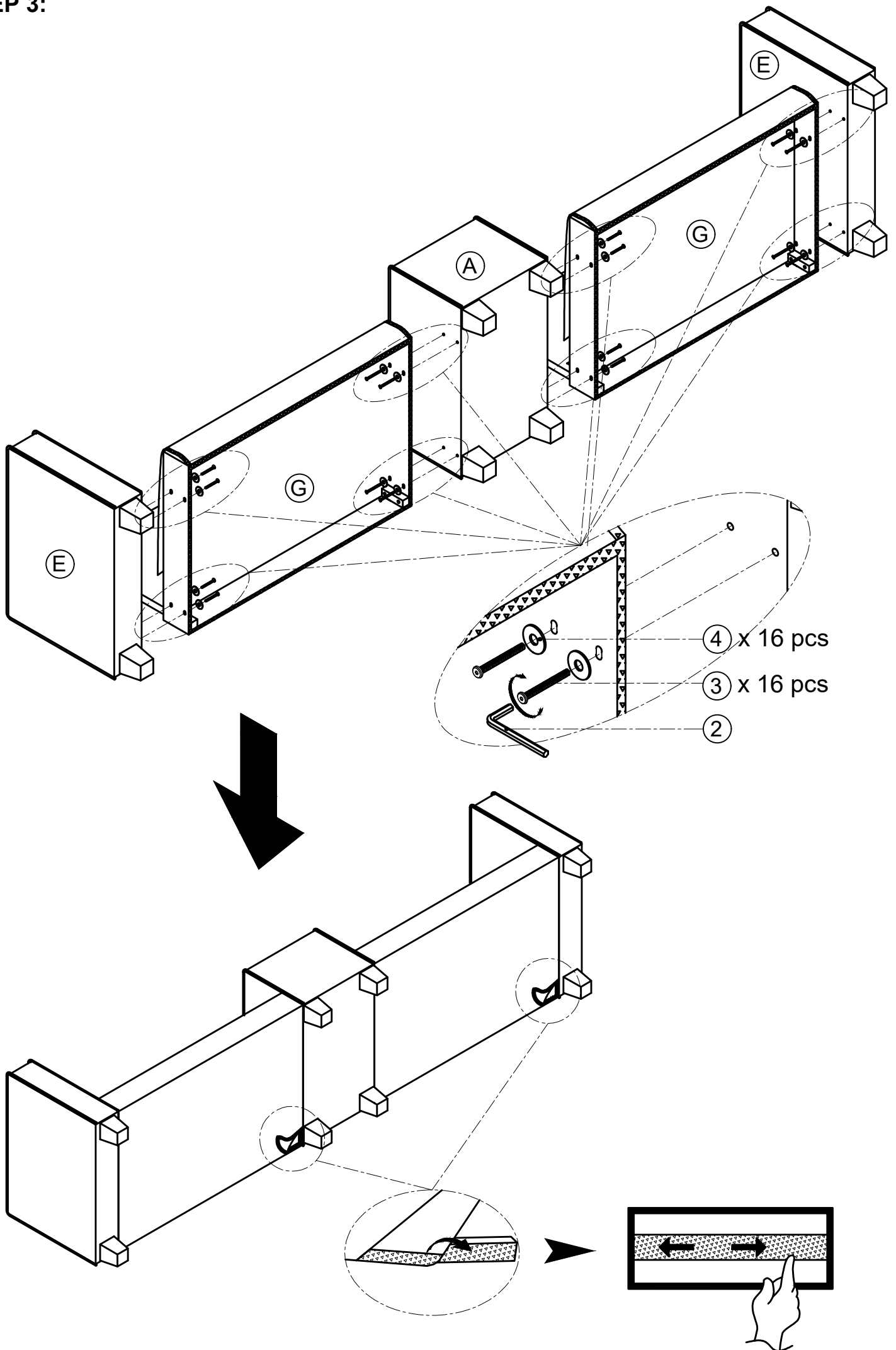

**STEP 4:**

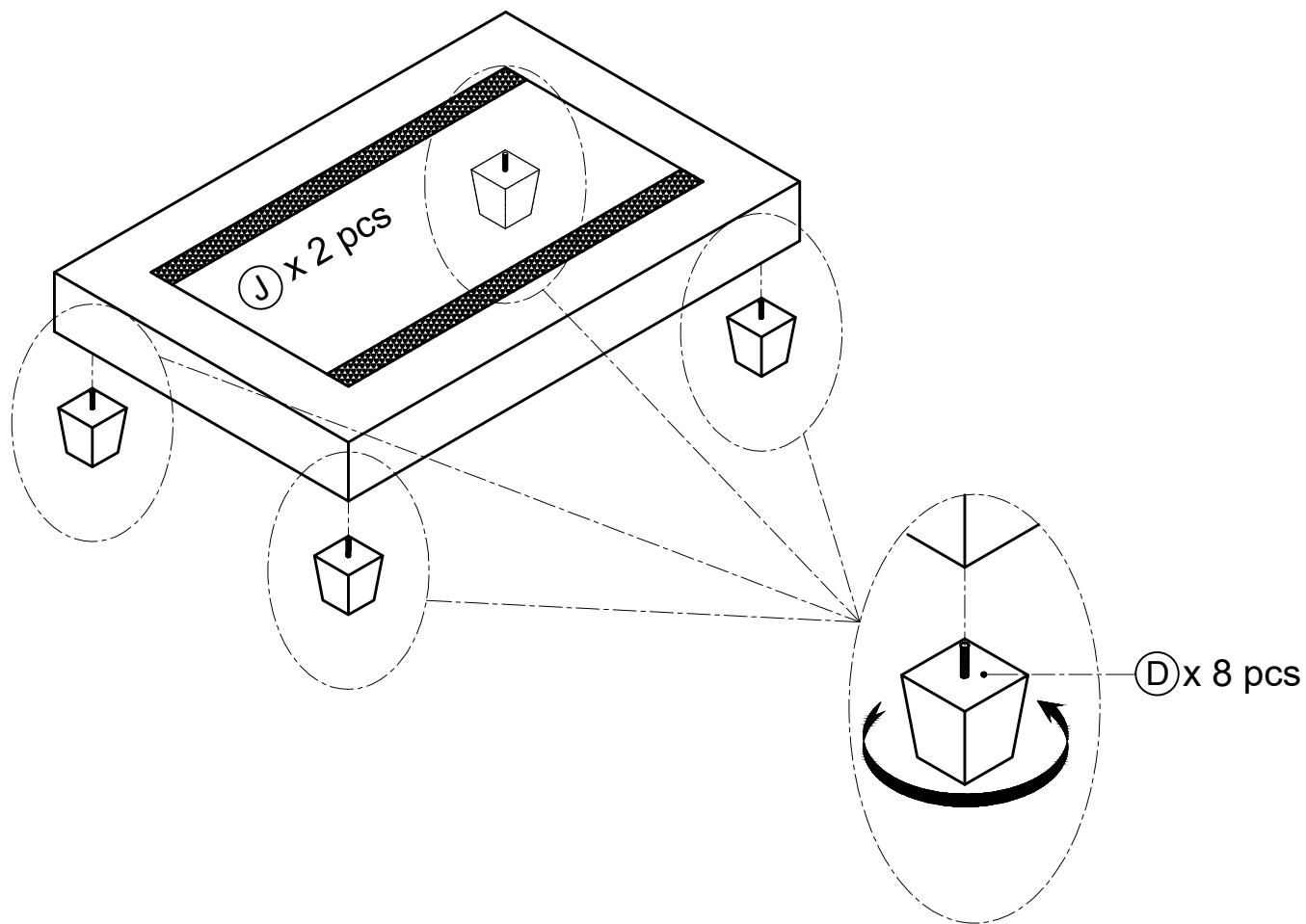

**STEP 5:**

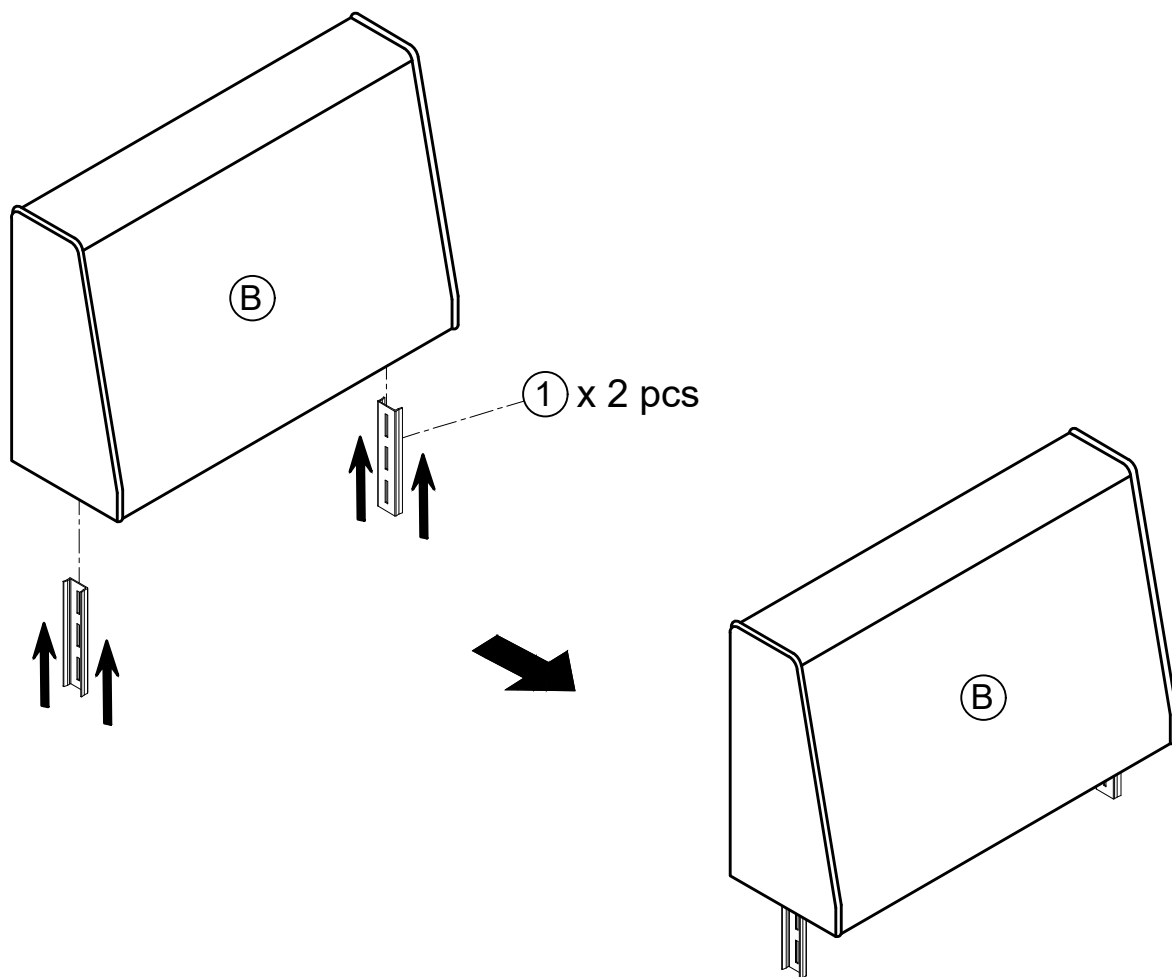

**STEP 6:**

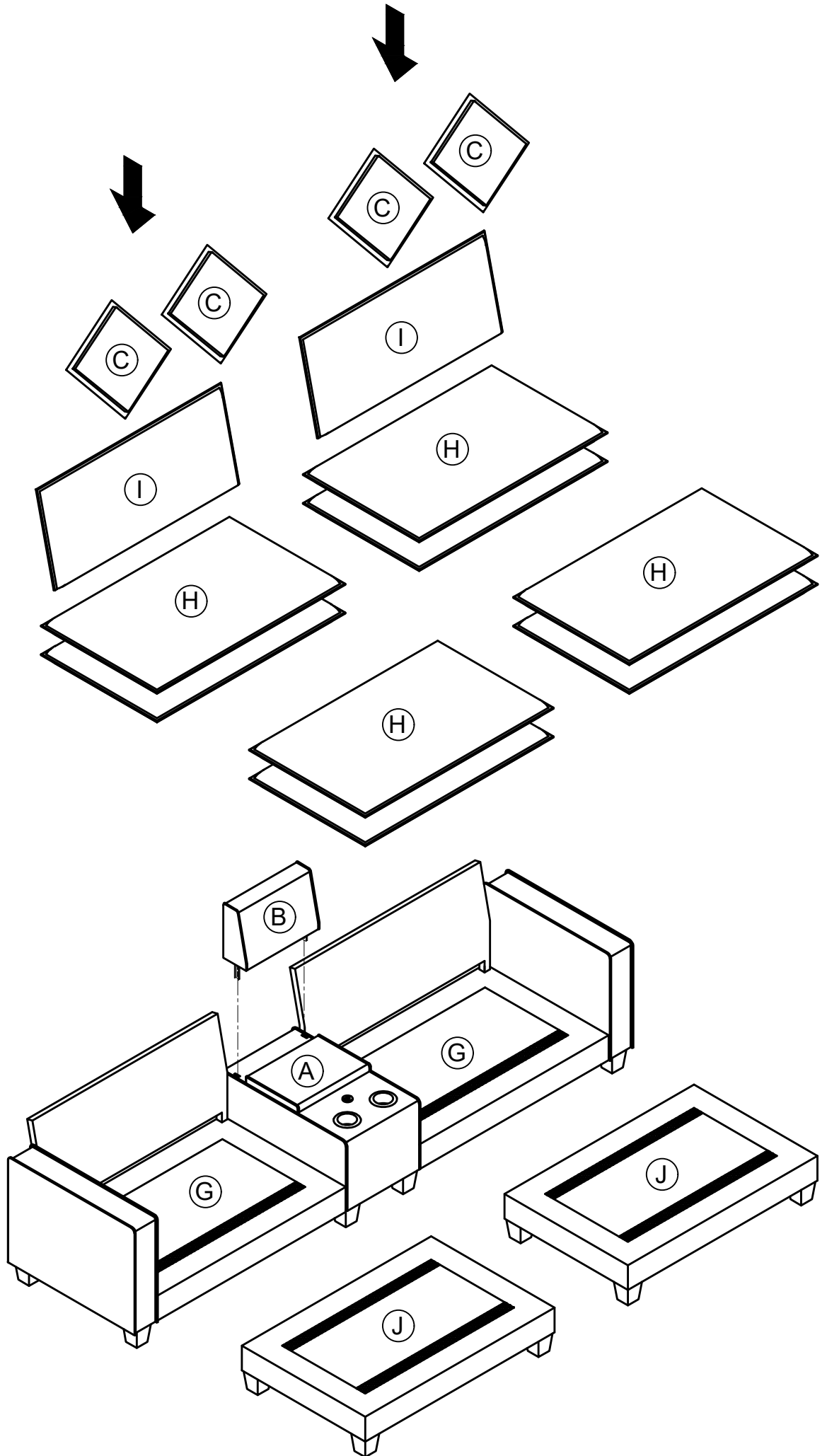

## Helpful Hints

- Move your new furniture carefully, with two people lifting and carrying the unit to its new location.
- Your furniture can be disassembled and reassembled to move.
- Clean the product with a soft damp cloth. DO NOT use harsh chemicals or abrasive cleaners.

## COMPLETED

