





















Assembly Instructions

Caution : You must read these Assembly Instructions before you proceed

Care & Maintenance

-   ● Not for commercial use. For residential use only.
-   ● Prolonged exposure to rain may cause rusting which can stain floors.
-   ● Do not put hot items directly on furniture surface.
-   ● Do not clean furniture with harsh cleansers or polish.
-   ● To obtain the longest lifespan of your outdoor products, minimizing exposure to direct sunlight is recommended.
-   ● Children should not climb or jump on the furniture.
-   ● Do not write on furniture without a padded barrier to protect the surface.
-   ● To obtain the longest lifespan of your outdoor products, avoid extended and lengthy exposure to rain, snow, and direct sunshine. Whenever possible cover the product and /or place under patio or awnings.
-   ● Stains may be removed with mild soap solution and damp cloth.
-   ● Dust and pick-up spills using a clean, non-colored, lint-free cloth.

Please look in the Seat Panel for hardware packs

SUN LOUNGER

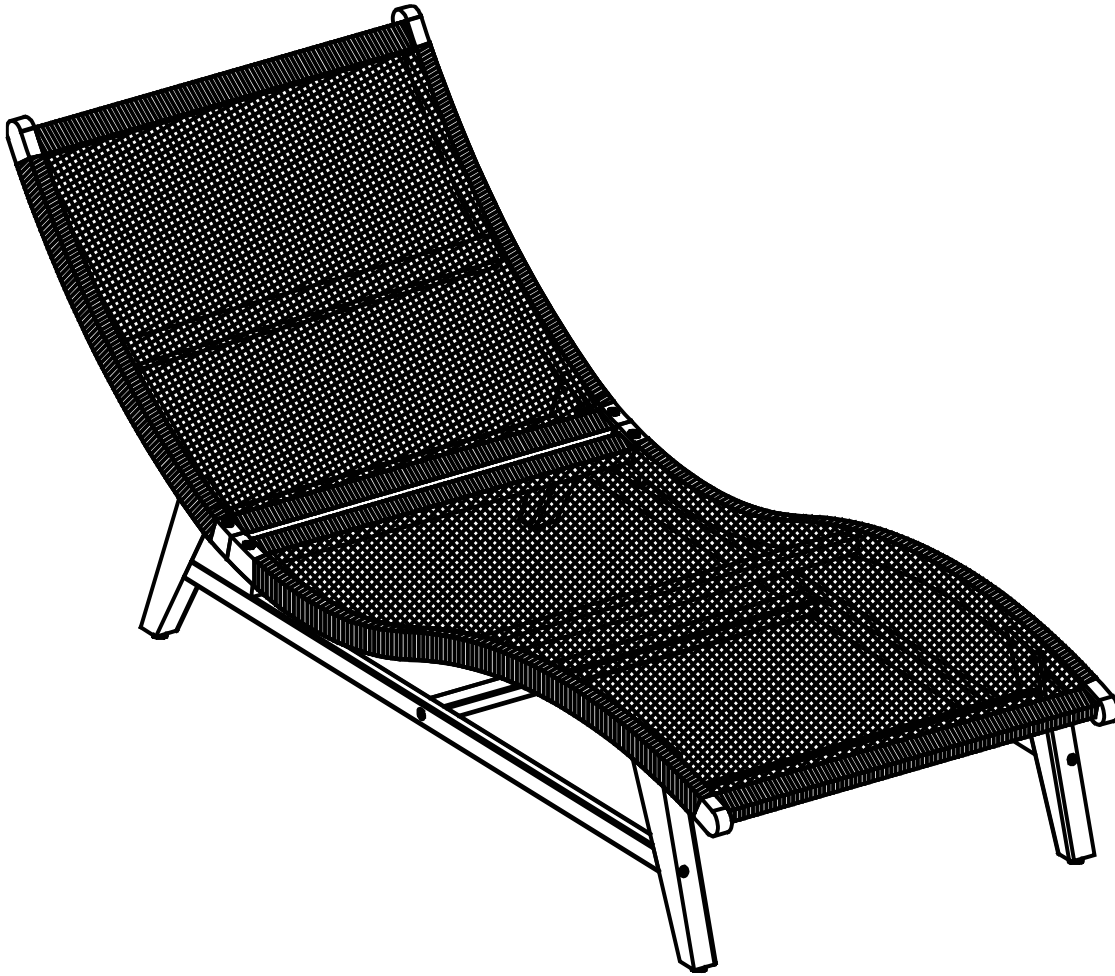



CAUTION: This Sun Lounger is NOT a TOY.



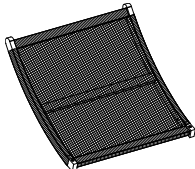
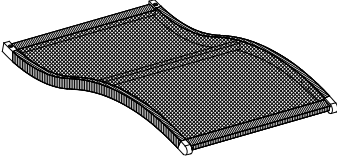
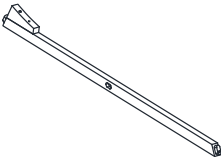
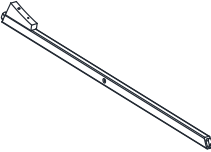

Keep your child / children at bay during the assembly process.

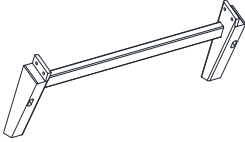
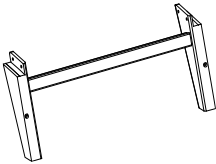
For moving the Sun Lounger and to prevent damage to the Sun Lounger, two adults may be needed to execute this action.

Parts List

Label	Picture	Description	QTY
A		Backrest Panel	1
B		Seat Panel	1
C		Right Seat Base Support Bar	1
D		Left Seat Base Support Bar	1
E		Support Bar	1
F		Back Leg panel	1
G		Front Leg panel	1

Hardware

Label	Picture	Description	QTY
①		Bolt (M6 x 30mm)	9
②		Screws (M6x60mm)	7
③		Screws (M6x100mm)	5
④		Allen Wrench	2

Assembly Preparation

Before Beginning Assembly:

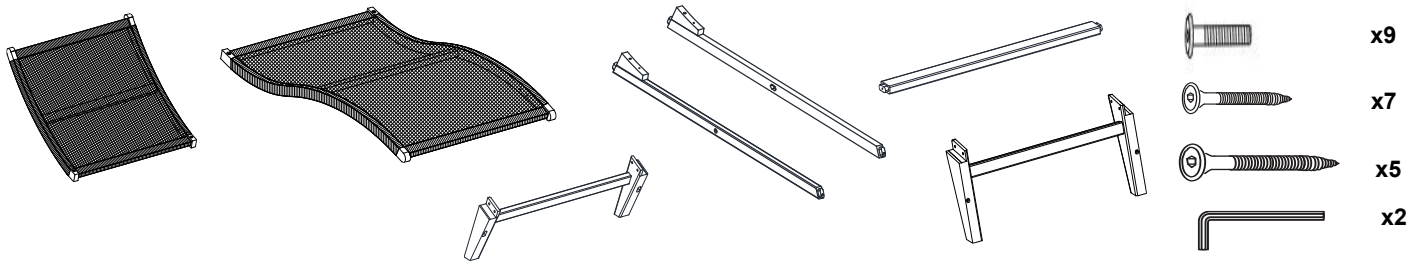

- Read instructions, cover to cover-



- Have 2 adults on hand for assembly-



- Do not assemble on flooring or carpet-



- Assemble on a clean non-marring surface (packing foam)-



- Save all packaging until finished-

Assembly Steps

OVERVIEW

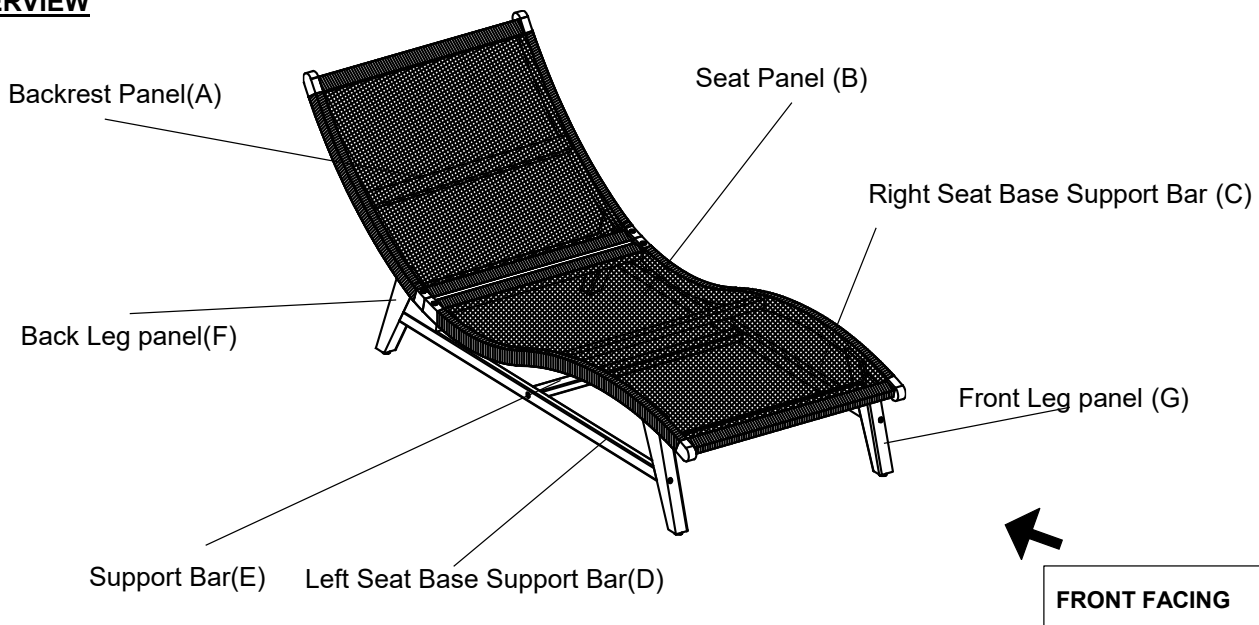

This Sun Lounger has multiple parts and may require up to some 30 minutes to assemble. To give you an overview of the Sun Lounger parts, the above picture is to help you put the various parts into perspective. Please read through the instructions below to familiarise yourself with the parts and steps before assembly.

Step 1

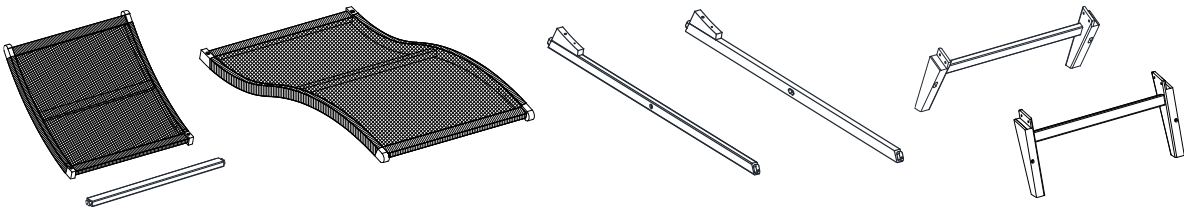

Unpack and place all parts on a clean, non-marring surface.

Step 2

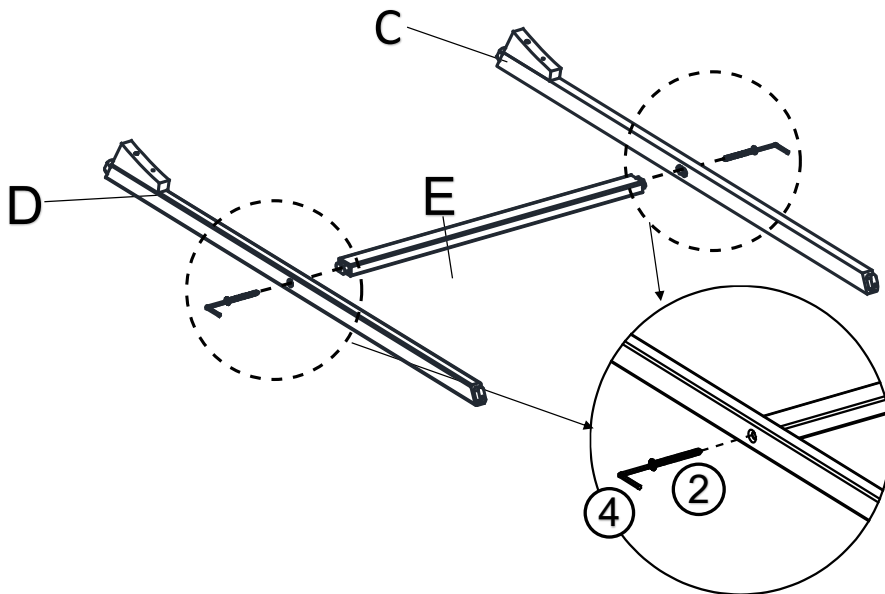

Place the Support Bar (E) onto the clean, non-marring surface
With the assistance from your adult partner, attach the Right Seat Base Support Bar (C) & Left Seat Base Support Bar (D) to the Support Bar (E) by using Screws (2) and Allen Wrench (4) as shown above
Do not fully tighten the Screws at this time

Step 3

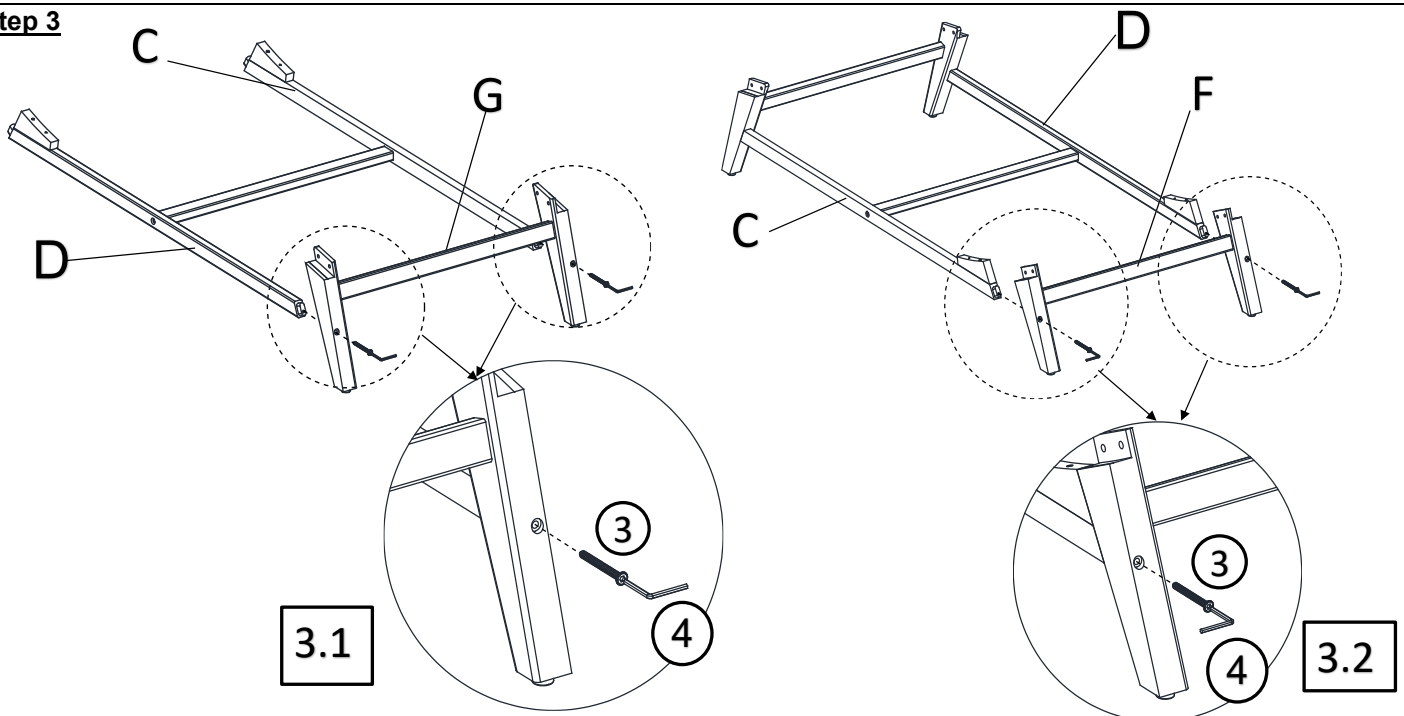

Lay down the assembled part in Step 2 on the ground as shown above. With the assistance from your adult partner:
3.1: Attach the Front Leg panel (G) to the assembled parts in Step 2 by using Screws (3), and Allen Wrench (4) as shown above.
3.2 Attach the Back Leg panel (F) to the assembled parts in Step 2 by using Screws (3), and Allen Wrench (4) as shown above.

Do not fully tighten the Screws at this time

Step 4

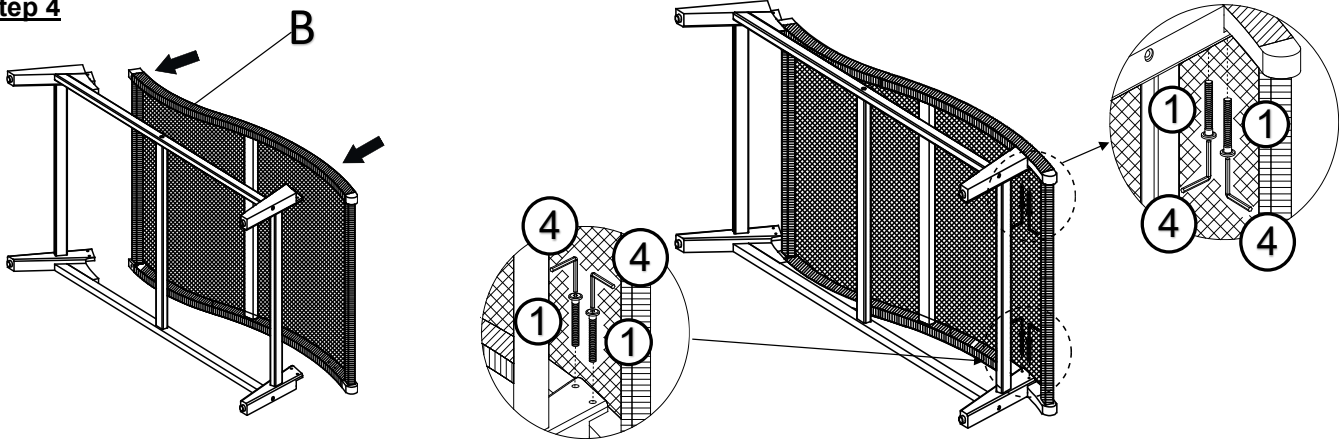

Arrange the assembled part in Step 3 as shown above. With the assistance from your adult partner:
Attach the Seat Panel (B) to the assembled parts in Step 3 by using Bolts (1) and Allen Wrench (4) as shown above.
Do not fully tighten the Bolts at this time.

Step 5

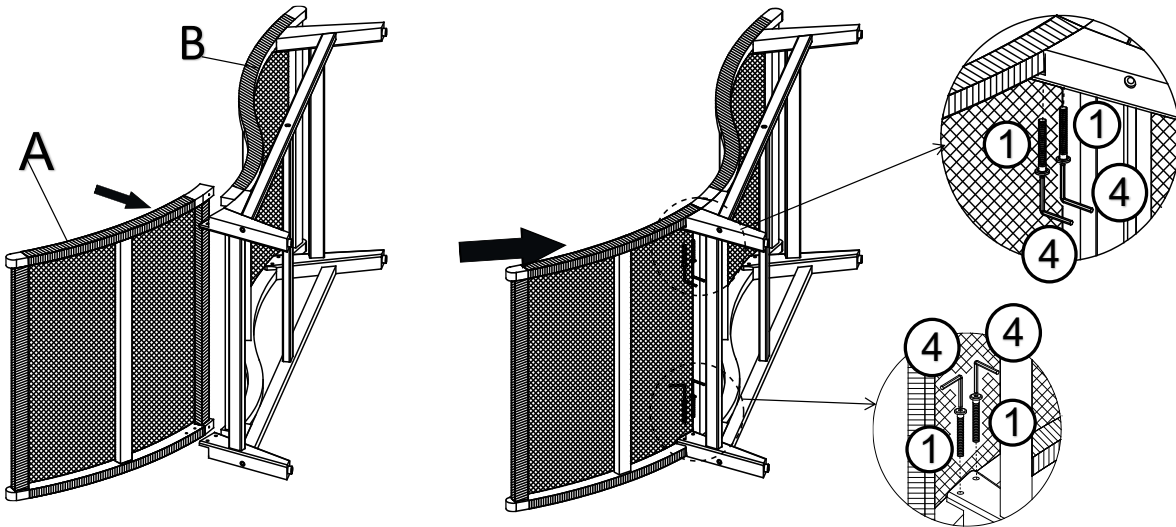

Arrange the assembled part in Step 4 as shown above. With the assistance from your adult partner:
Attach the Backrest Panel (A) to the assembled part in Step 4 by using Bolts (1) and Allen Wrench (4) as shown above.
Do not fully tighten the Bolts at this time.

Step 6

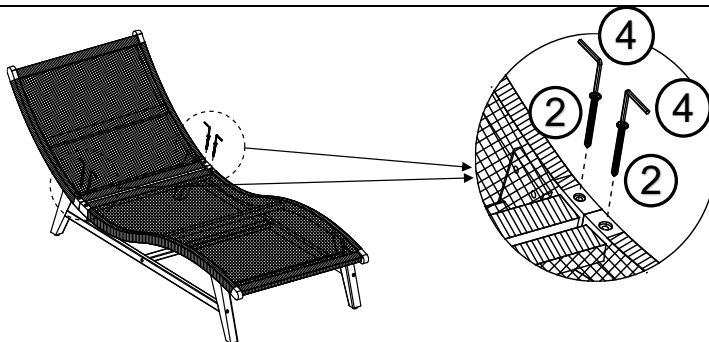

Turn the Sun Lounger right side up and attach them by using Screws (2) and Allen Wrench (4) as shown above.
Do not fully tighten the Screws at this time.

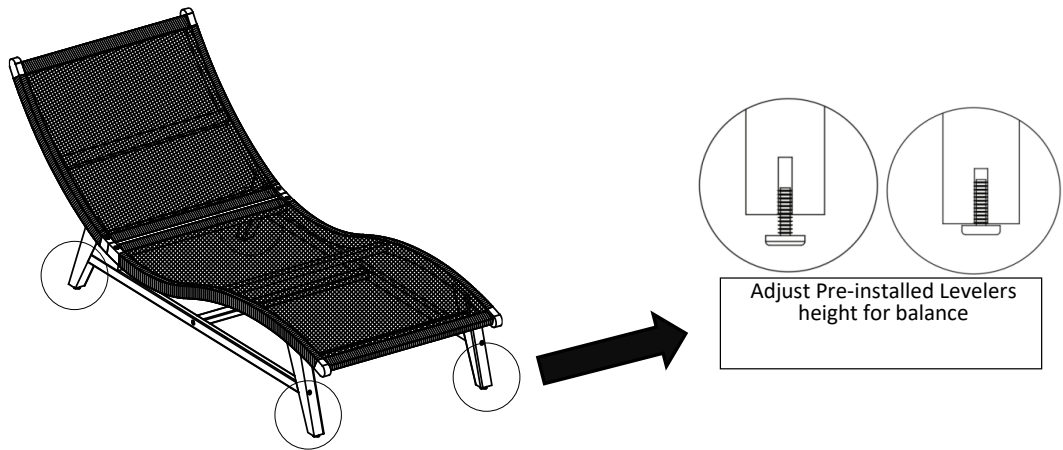

Turn the Sun Lounger right side up.
Inspect the Sun Lounger and make sure all parts are adequately connected.
In a sequential manner, tighten all Screws and Bolts at all joints.
With assistance from your adult partner, adjust the Levelers to the desired height to avoid wobbles.

CAUTION: When tightening these screws and bolts, tighten sequentially.
DO NOT tighten any screw or bolt fully and then move towards the next one. This could cause the frame to warp.
WARNING!! IF THE SUN LOUNGER IS NOT STABLE , IT COULD LEAD TO DAMAGING THE PRODUCT.

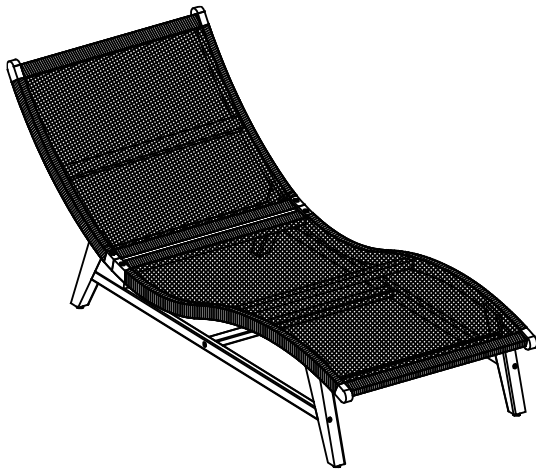

Place the Sun Lounger on a **LEVEL SURFACE**.
Inspect it and make sure all parts are adequately connected.
Gently and gracefully, sit onto the Sun Lounger.
This will help align all the parts at all joint areas.
Then get off the Sun Lounger and proceed to tighten the Bolts and Screws in a sequential manner.
When tightening the Bolts and Screws, tighten sequentially.
DO NOT tighten any Bolts and Screws fully and then move on towards the next one.
If there are any wobbles after tightening, loosen the Bolts/Screws and execute this same process.

The Sun Lounger is ready to be used.
This Sun Lounger can only be used on a flat, level surface.

Questions & Answers about Proposition 65

- What is Proposition 65?

Proposition 65 requires businesses to provide warnings to Californians about significant exposures to chemicals that cause cancer, birth defects or other reproductive harm. These chemicals can be in the products that Californians purchase, in their homes or workplaces, or that are released into the environment. By requiring that this information be provided, Proposition 65 enables Californians to make informed decisions about their exposures to these chemicals.

Proposition 65 also prohibits California businesses from knowingly discharging significant amounts of listed chemicals into sources of drinking water.

Proposition 65 requires California to publish a list of chemicals known to cause cancer, birth defects or other reproductive harm. This list, which must be updated at least once a year, has grown to include approximately 900 chemicals since it was first published in 1987.

- What types of chemicals are on the Proposition 65 list?

The list contains a wide range of naturally occurring and synthetic chemicals that include additives or ingredients in pesticides, common household products, food, drugs, dyes, or solvents. Listed chemicals may also be used in manufacturing and construction, or they may be byproducts of chemical processes, such as motor vehicle exhaust.

- What does a warning mean?

If a warning is placed on a product label or posted or distributed at a workplace, a business, or in rental housing, the business issuing the warning is aware or believes that it is exposing individuals to one or more listed chemicals.

By law, a warning must be given for listed chemicals unless the exposure is low enough to pose no significant risk of cancer or is significantly below levels observed to cause birth defects or other reproductive harm.

- Where can I get more information on Proposition 65?

If you have specific questions on the administration or implementation of Proposition 65, you can contact OEHHA's Proposition 65 program at P65.Questions@oehha.ca.gov, or by phone at (916) 445-6900.