











# Assembly Instructions

Caution: You must read this before you proceed

A		table top	<b>1PC</b>
B		table legs	<b>2PCS</b>
C		apron	<b>2PCS</b>
D		glass	<b>1PC</b>
E	 M6*20mm	screw	<b>4PCS</b>
F		washer	<b>20PCS</b>
G		spanner	<b>1PC</b>
H		spanner	<b>1PC</b>
I		nut	<b>8PCS</b>
J	 M6*30mm	screw	<b>8PCS</b>
P		umbrella cover	<b>1PC</b>

# Assembly Instructions

## Table

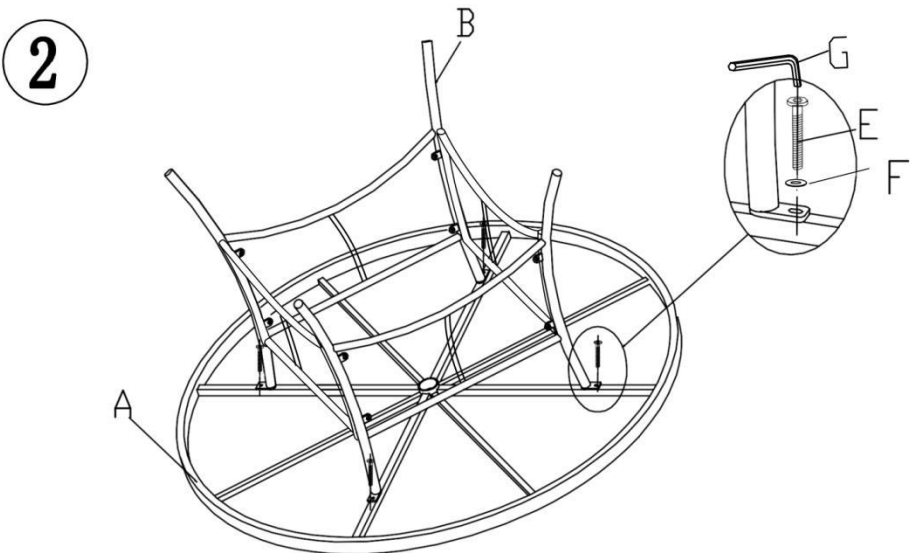
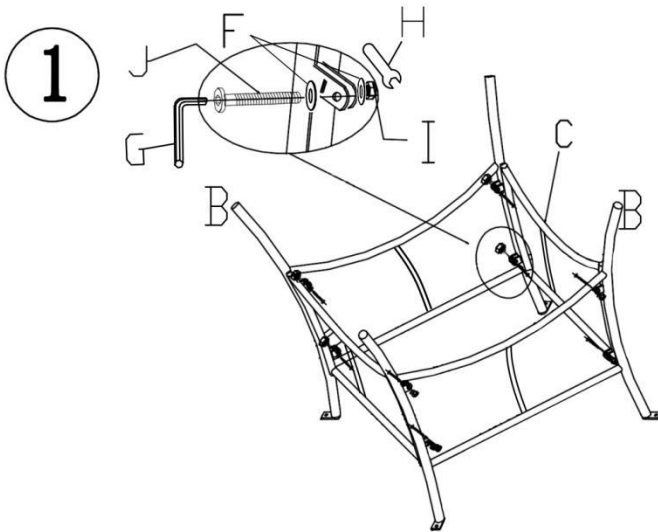

# Assembly Instructions

3

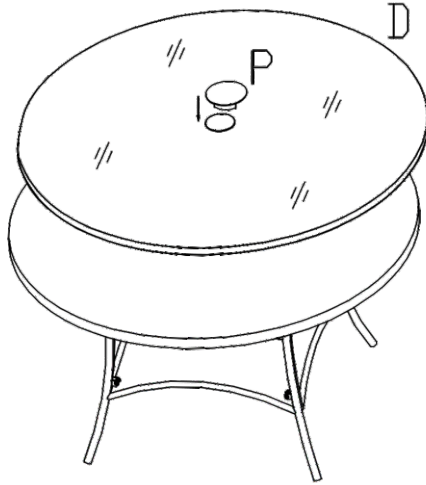





4

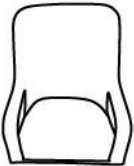

# Assembly Instructions

Caution: You must read this before you proceed

A		1 PCS
B		1 PCS
C	 M6X40	6 PCS
D		6 PCS
E		1 PCS

# Assembly Instructions

Attach part (A) and part (B). Put the washer (D) through the screw (C), then insert the screws (C) into the screw holes. Use (E) to tight the Chair.

①

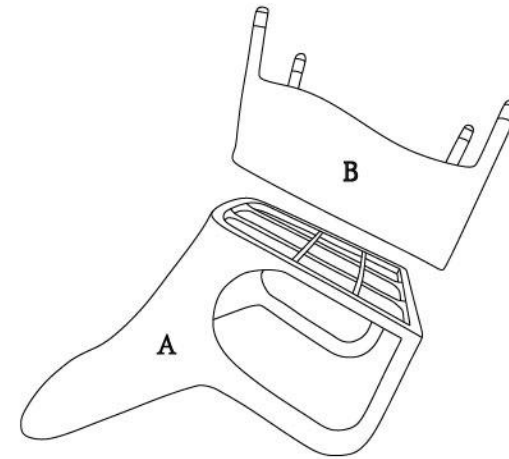

②

