

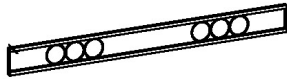











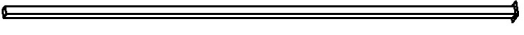

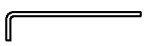

**4368 – WALL MOUNTED GAZEBO**

A	1				
B	1				
C	1				
D	1				
E	2				
G	2				
H	2				
I	1				
J	10				
K	4		L	22	
M	8		N	2	
O	1		P	2	
Q	2			1	
Ni	2				

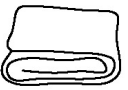
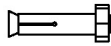

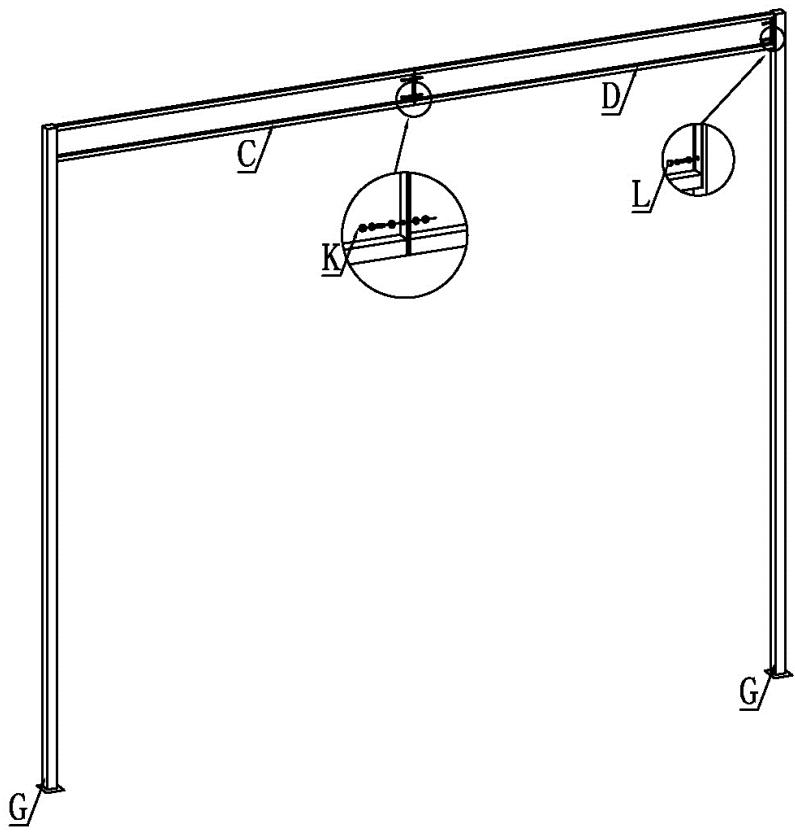
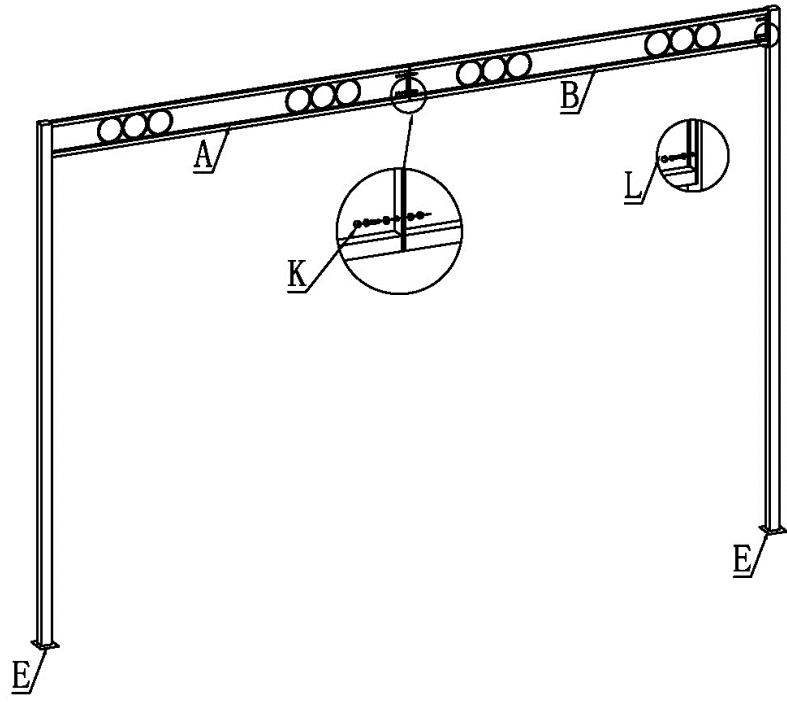
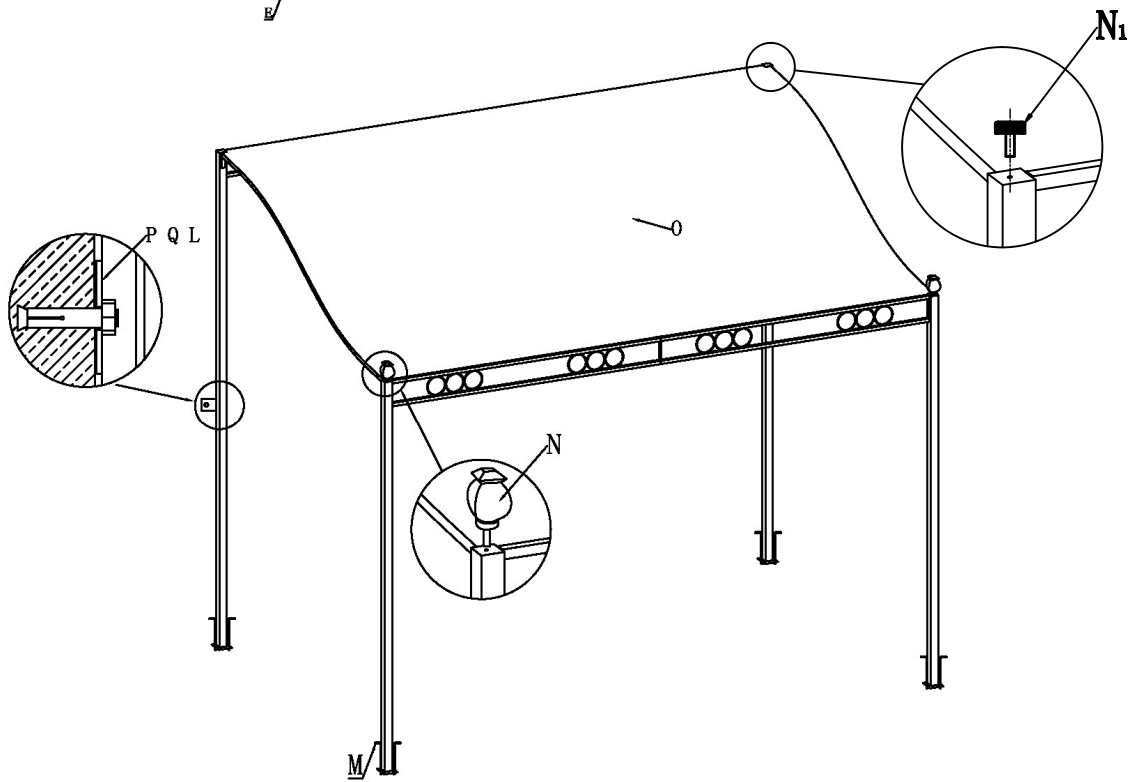
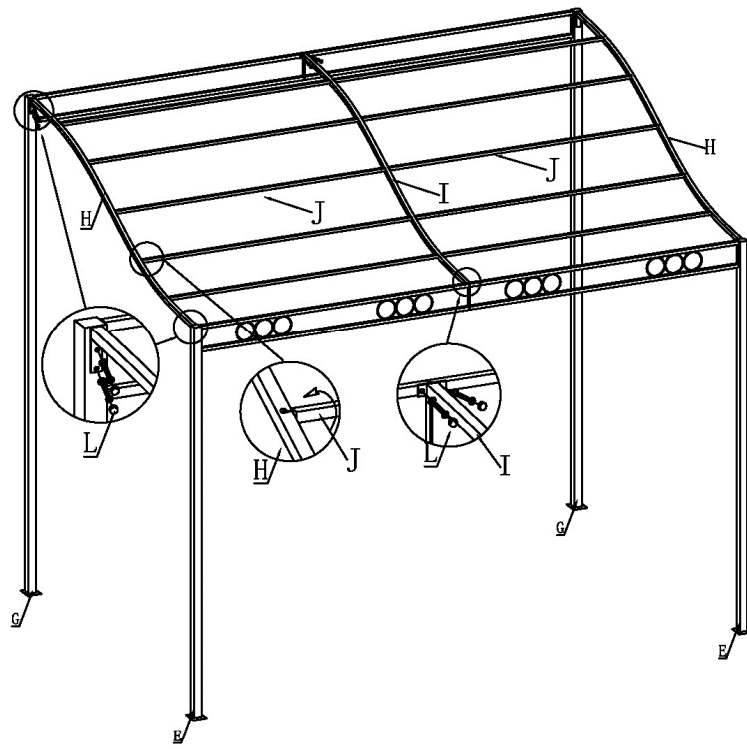

The Gazebo is intended to provide shade from direct sunlight only and not protection from the harsher elements such as rain and wind. The fabric should always be removed in such conditions or when the item is not in use in case the weather should change for the worse.