

FULL-AUTOMATIC WASHING MACHINE

USER MANUAL

MODEL NO.:XQB60-2248A

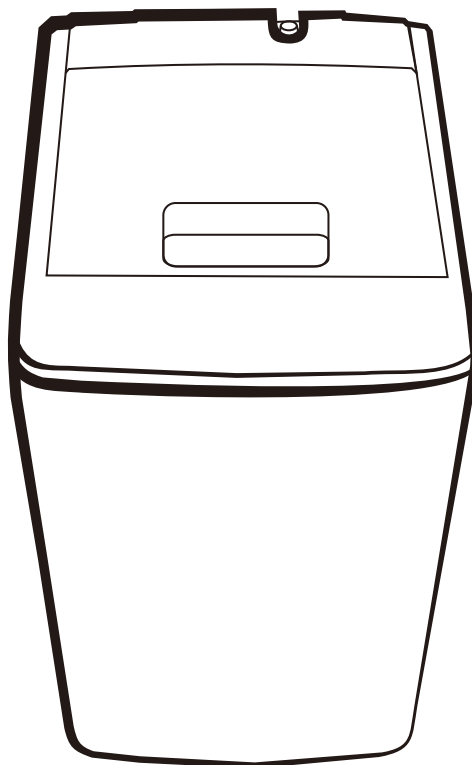

MADE IN CHINA

Please read the User Manual carefully before operating the Washing Machine

- ① **Product's Specifications Are Subject To Change Without Prior Notice.**
- ② **Actual Product May Differ From Pictures Shown.**
- ③ The factory will conduct a drainage test on the washing machine after production. There may be some water remaining in the drain pipe. This phenomenon is not a quality issue and can be used normally.

CONTENTS

1. PART IDENTIFICATION	-----	2
2. SPECIFICATIONS	-----	2
3. CONTROL PANEL	-----	3
4. INSTALLATION	-----	4
5. OPERATION AND PROGRAMS	-----	6
6. GUIDE FOR SAFETY AND DURABILITY	-----	8
7. MAINTENANCE	-----	9
8. WIRING DIAGRAM	-----	10
9. TROUBLE SHOOTING	-----	11
10. CHILD-PROOF SETTING	-----	12

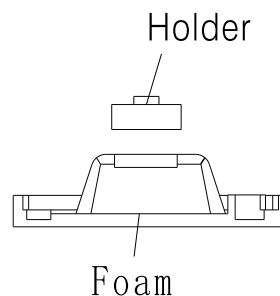
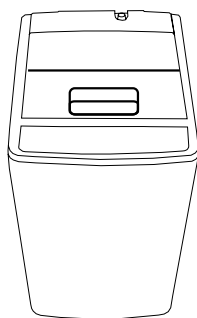
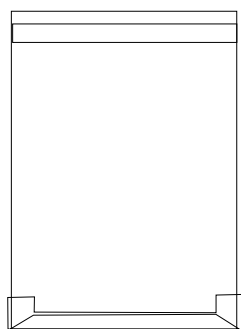

- Please take out washing machine from foam when use, otherwise there will be big noise or damage machine

PART IDENTIFICATION

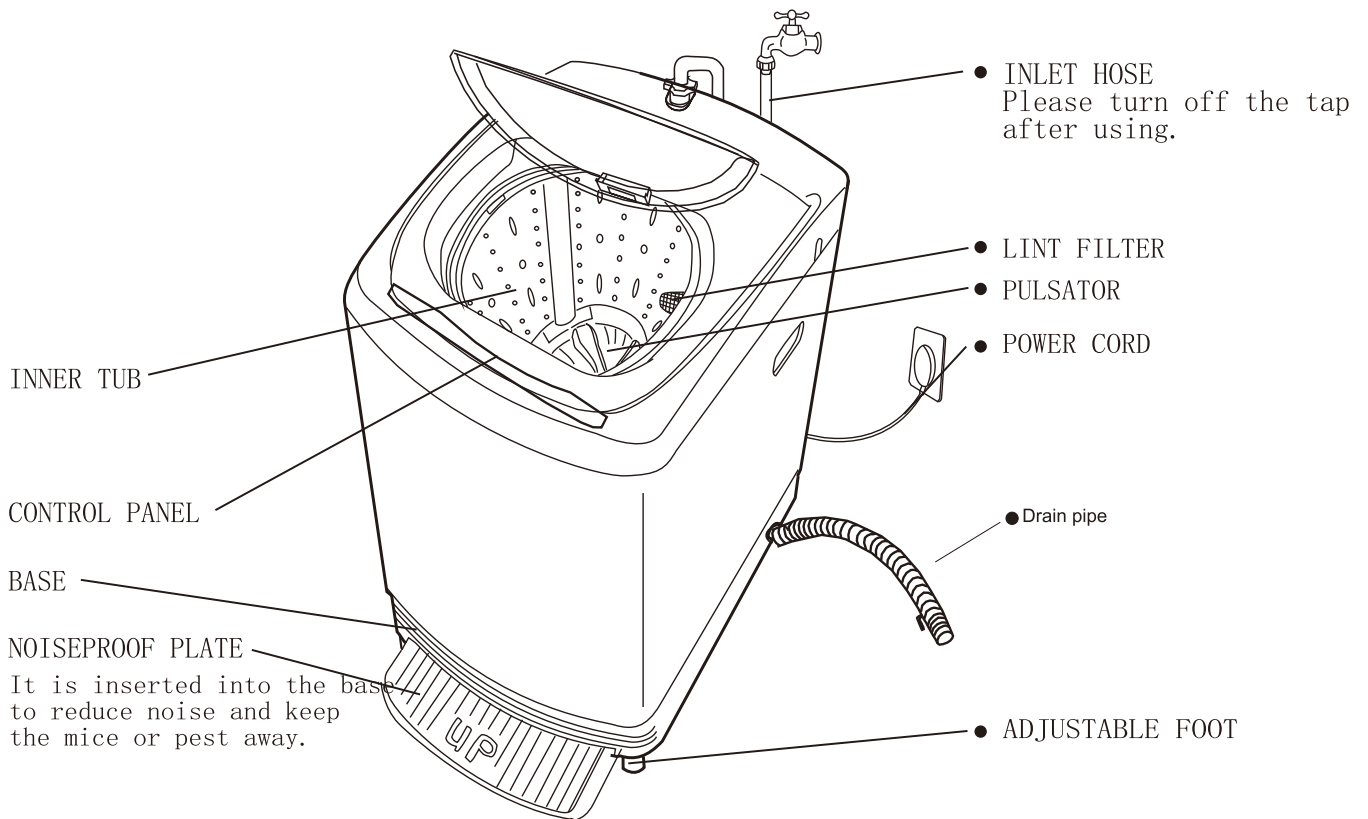

ACCESSORIES

Name	Quick Adaptor	Water Inlet Hose	User Manua	Bottom Cover
Quantity	2	1	1	1

SPECIFICATIONS

MODEL	XQB60-2248A
CAPACITY	2.4Cu.ft
VOLTAGE	110V~60Hz
POWER(WASH/SPIN)	300W
NET DIMENSION	470x475x840mm
GROSS/NET WEIGHT	21kg/24kg

CONTROL PANEL

DETERGENT	WATER LEVEL	PROCESS	REMAINING TIME(MIN)	AIR DRY	PROGRAM DISPLAY
 7-8L	AA SOAK	AIR DRY MIN	 30 MIN 60 MIN 90 MIN 10 MIN 20 MIN	01 NORMAL 06 SOAK
 5-6L	bb WASH	WATER LEVEL		02 STANDARD 07 WASH
 3-4L	[[RINSE	PROGRAM PRESET(HOUR)		03 QUICK 08 SPIN
 1-2L	dd SPIN			04 LARGE 09 WASH+RINSE
					05 AIR DRY 10 RINSE+SPIN



INSTALLATION

Install the washing machine on a firm and level surface.

■ Install the washing machine on a firm and level surface so as to prevent vibration during operation. Keep the washing machine more than 5cm far away from the wall so as to prevent the noise emitting while the intub is turning.

■ Alternation of adjustable foot
Loosen the level adjustment knob, make the washing machine stable, and then tighten the knob. (The inclination angle of the washing machine shall not be more than 5°).

INSTALLATION

Connecting the drain hose

- Connect the drain pipe into drainage hole

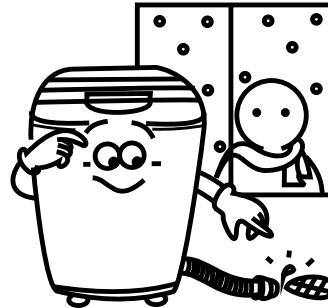

Insert the noiseproof plate into the washing machine base

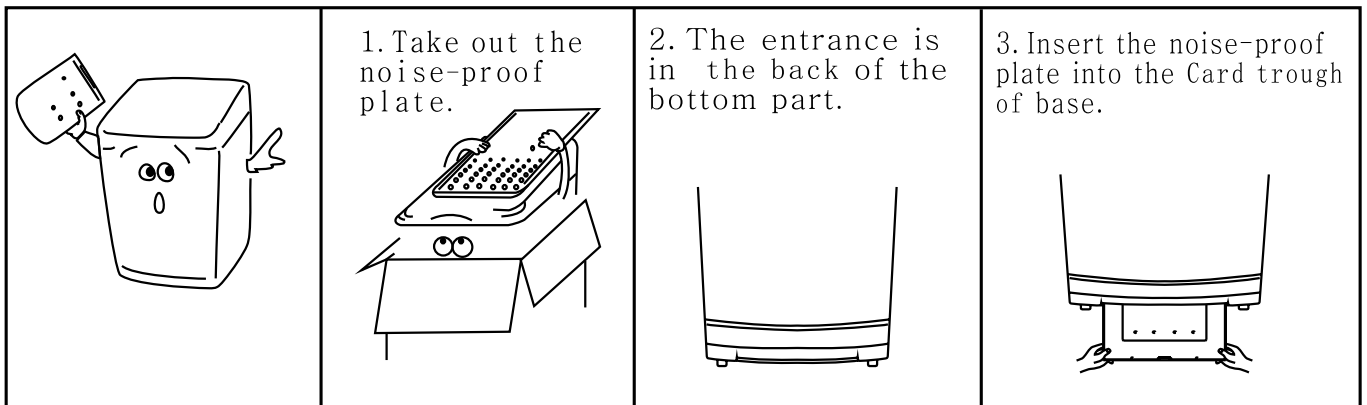

About power and ground connection:

The ground wire of the washing machine is set in the plug, don't try to modify it.
The socket should have reliable ground wire. If no ground wire in socket, please call the technician to assemble.
The socket should have assembled the 3A fuse.

Note:

Never try to connect the ground wire of the washing machine together with that of gas pipe or water pipe, telephone cord or lightning rod.
Do not use the damaged cord because it could cause electrical leakage and fire.
In case cord is damaged, call the local service company to change it.

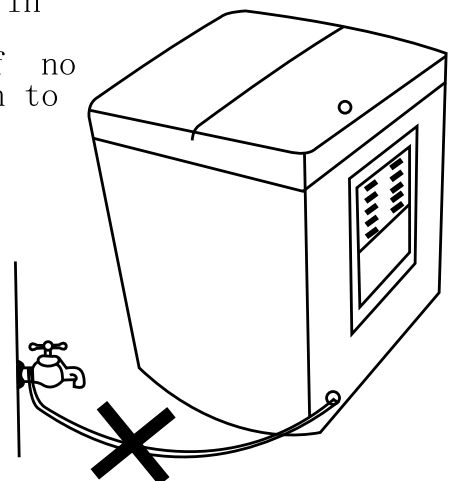

INSTALLATION

Faucet

A: Select appropriate type of faucet as shown in the figure.

B: End of faucet spout should be more than 16mm, or the connector cannot be assembled.

C: Water leakage is possible from here.

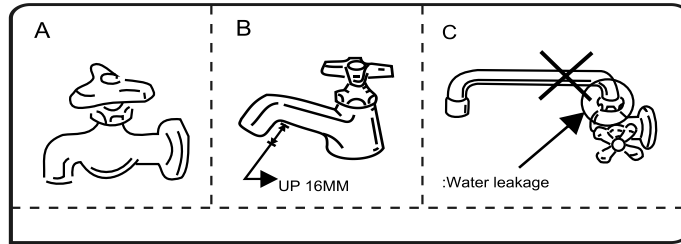

The inlet hose connector includes two parts: fixed socket and movable connector. Before using, press down the clip of the movable connector and take out the fixed socket (as shown in the illustration).

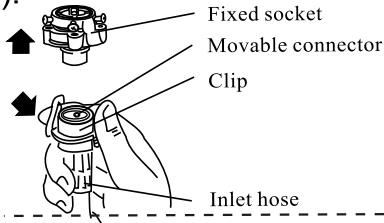

Fixed socket is divided into A and B part. A clip connects these two parts. When installing, loosen part A and B about 4mm

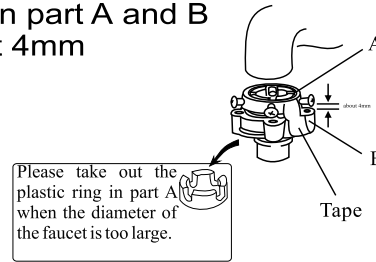

Fasten up B anti-clockwise and seal the rubber to the faucet until there is no leakage

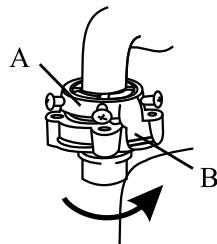

Loosen four screws in part A and set it horizontally to the tap. Push it upward till the rubber sticks to the faucet rim, keeping the faucet to the center then fasten up the four screws.

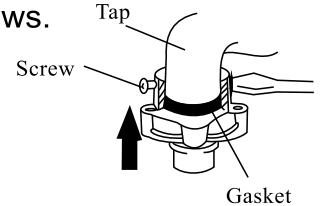

Connection of the inlet hose

1. After pressing down the clip of the movable connector, three small steel balls will be seen. Insert the clip into the fixed socket

2. Loosen the clip and push it upwards until the movable connector and the fixed socket are firmly in place.

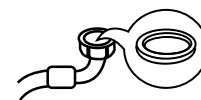
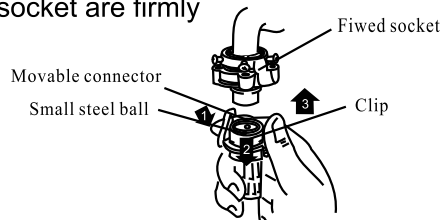

To prevent water leakage, please ensure the connecting nut is tightened securely. If water leakage, check the nut whether it is filled with rubber ring.

OPERATION AND PROGRAMS

Preparation

- 1) Connect the inlet hose and turn on the faucet, don't switch on the power if water pressure is lower than 0.05 Mpa or higher than 1.2 Mpa.
- 2) Open the faucet.



- 3) Please set the plug into the socket. For the sake of safety the plug should have ground connection.

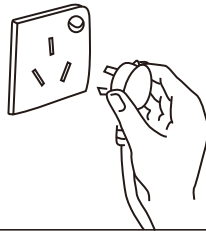

- 4) Insert the end of drain pipe into drainage hole.

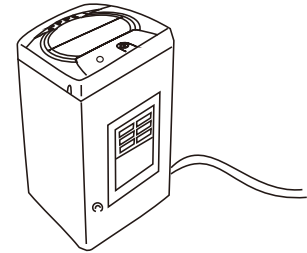

- 5) Add the suitable quantity wash load into the tub.

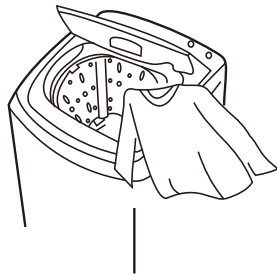

- Press down each button in 5 minutes since the program is over can re-assemble the process group. Then press down "START/PAUSE" button to re-start the washing machine. If not, the washing machine will shut down automatically.
- Please close the lid, or the washing machine will buzz in spinning.

Drain Hose Usage

Connection of the drain hose

Insert the end of the drain hose into the hook shelf, and hang the drain hose over a drain outlet .

Note: The highest point of the drain hose must be in the height of 0 inch ~ 39.37inch above floor level, otherwise, the washer can not work normally.

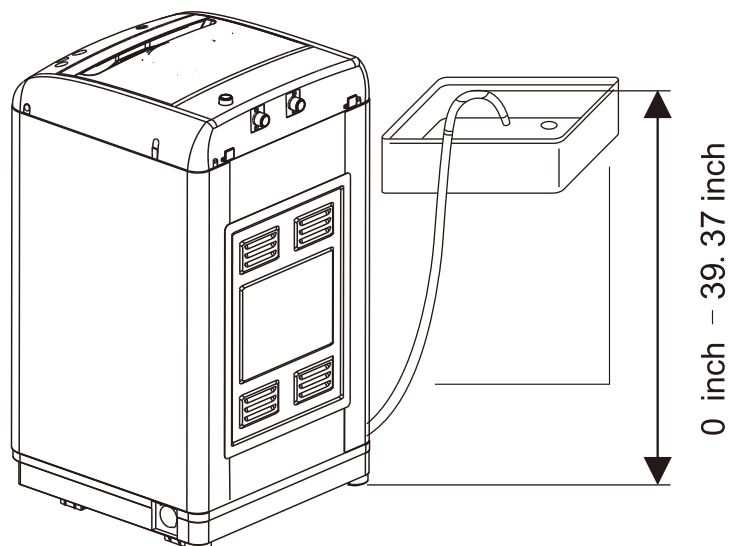

Operation instructions

Washing Procedure

1. Press the power supply ON/OFF key

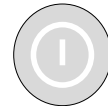

2. Press the program key

- Select washing program



3. Press the water level key

- According to cloth nature and clothes weight, the suitable water level is selected.

4. Close the top cover

- Before appointed startup, the top cover must be closed; otherwise, fault E3 occurs after appointed startup.





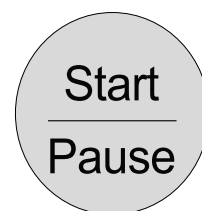



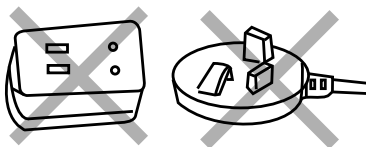
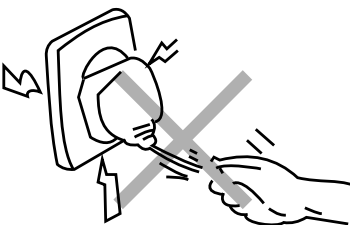

5. Press the start/pause key

- Press the startup key, the appointed time in information window flickers while other indicator is off; when appointed time is set, washing operation starts

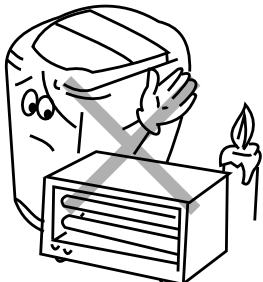

GUIDE FOR SAFETY AND DURABILITY

Pay attention to the following guidance.

<p>■ Do not expose washing machine to direct sun light or rain.</p> 	<p>■ Do not place the washing machine in a damp place.</p> 	<p>■ Do not humidify the switches.</p> 
<p>■ Never use the plug as shown.</p> 	<p>■ Do not only hold the cord while pulling out the plug.</p> 	<p>■ Do not let children to play with the machine.</p> 
<p>■ Keep the washing machine away from fire or heat source.</p> 	<p>■ Do not clean the body of machine with volatile solvent such as petrol and methane.</p> <p>Also, do not pour these solvents into the tub for washing or drying purposes.</p> 	<p>■ Never use water above 50°C</p> 
<p>■ Make sure the lid is closed especially during spin.</p> 	<p>■ Do not put hands into the rotating tub.</p> 	<p>■ Drain water completely.</p> 

MAINTENANCE

Clean the filter in the inlet valve regularly in order to prevent it from clogging. **Body Maintenance**

1. Unplug the power cord.

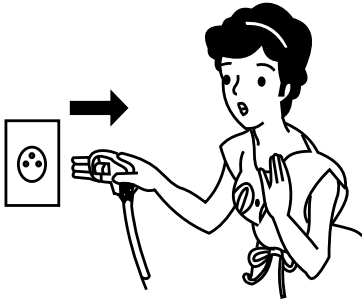

2. Remove the inlet hose and clean the filter with a brush.

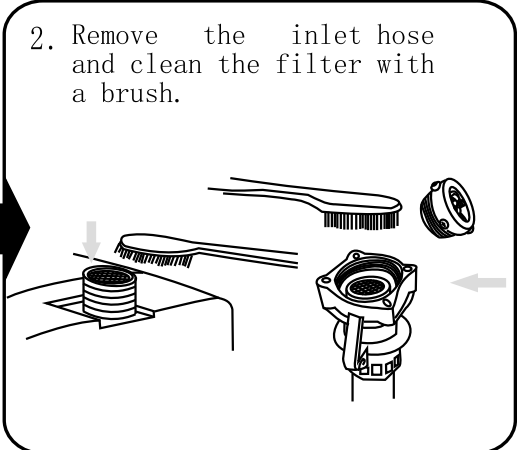

- Clean the surface of the washing machine with a soft cloth regularly.
- Clean the inner tub regularly, especially after washing starched or bleached laundry.

Clean the lint filter.

1. Pull upward to remove the lint filter.

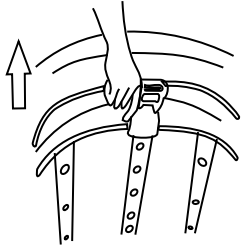

2. Clean and rinse it thoroughly.



3. Reinstall.

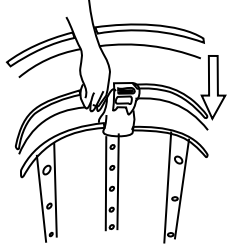

MAINTENANCE

Use of decolourant

- ★ pour decolourant slowly into decolourant slot white water inletting.
- ★ avoid put decolourant on clothes directly.
- ★ follow the declolourant instruction.

Use of softener





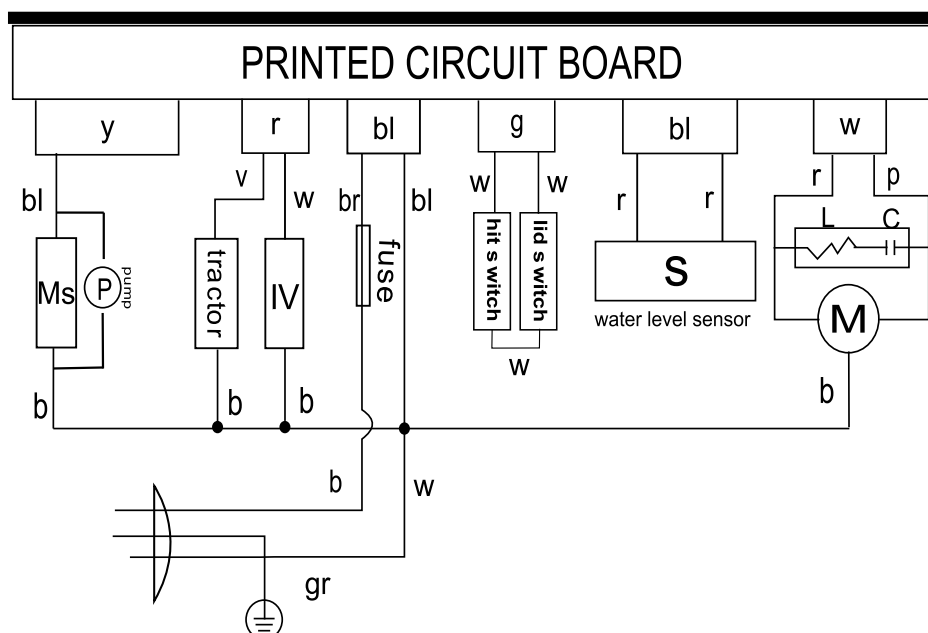



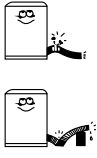

- ★ The maximum amount for once is 27ml.
- ★ Use 3 times of water to dilute concentrated softener before use.
- ★ Intenerating effect may be inefficient due to add too early; in contrast, the softener may be concreted in the tub due to long time unused after pouring in.
- ★ Softener can be concreted easily and cleaning is required after applying. Put 30ml warm water (about 30°C) into the softener slot for 5 minutes and then press "SPIN" button to start spinning process for 2 minutes.
- ★ Don not open the lid while spinning process is functioning.

WIRING DIAGRAM



Troubleshooting

Troubleshooting

Problem	Checklist		
Unable to drain  If the draining time passes 10 min, the washing machine will buzz and indicate "E1".		Is the drain hose distorted or the upholder is too high? Is the drain iced or blocked?	
Spin malfunction  If the machine does not spin after draining, it will buzz and indicate "E2".	 Is the lid closed completely?	Please call the technician to check whether the safety switch is damaged or not.	
Unable to Spin  The machine will attempt to spin three times, if unsuccessful it will buzz and indicate "E3".	 Is the load uneven?	 Is the machine installed on an uneven surface?	Please call the technician to check whether the safety switch is damaged or not.
Failed to fill with water  When water filling passes 20 min. It will buzz and indicate "E0".	 Is the tap turned off? Is there no water supply? Is the water flow too slow?	 Is the filter in the tap connector or inlet valve blocked?	Please call the technician to check whether the safety switch is damaged or not.
The machine gives alarm for about 10 seconds when the start / pause button be pressed. 	Call technician to check whether the connection of water level sensor loosened or the sensor damaged.		

- Note: 1. If trouble occurs, open/close the top cov as to release trouble information. After the trouble information is released, the trouble may occur again in the coming procedure if the trouble is not removed.
2. If voltage is too low, washing machine might run abnormally, just operate the machine till voltage is restored.
3. Water inlet pressure is less than or equal to 1.2Mpa.

Non-user maintenance items

- Power cord must not replaced by user, and it must be replaced at professional maintenance station.
- Microcomputer board must not be replaced by user without authorization. if it is required to replace, the replacement must be carried out by professional maintenance station of our company.
- Electronic water-level sensor must not be replaced by user freely. if it is required to replace, the replacement must be carried out by professional maintenance station of our company.

CHILD-PROOF SETTING

Your washing machine is equipped with a child safety setting that will once activated sound an alarm and drain the wash water in the event the lid is opened during operation.

If after the child safety setting is activated, the lid is opened during operation a loud alarm will sound. If the lid is not closed within 10 seconds, the wash water will be drained automatically.

If you have small children, it is recommended that you activate this setting every time you use the washing machine as children can be attracted to and enticed to play with the washing machine.

- Select the desired washing program as described previously in this manual
- Select the appropriate program and press START/PAUSE button to start the washing machine.
- Press and hold both the PRESET and PROGRAM buttons together to activate the Child-Proof Lock. The digital indicator will show and the remaining wash time.

Note:

When set up Child-Proof Lock, if the lid is opened while the machine is running, all operations will be stopped immediately and an alarm will sound and will automatically drain all water if the lid is not closed in 10 seconds. To resume operation, close the lid.

As a default when Child-Proof Lock is not activated, if you open the lid while the machine is running, all operations will be stopped within 10 seconds and will automatically drain water in 30 seconds and sound an alarm. To resume operation, close the lid.

Note:

As washing machines and other appliances are considered to present a potential child entrapment danger; you should never run a wash cycle when you are not present for either the entire or major portion of the cycle.

WARNING

- **This appliance is not intended for use by persons (including children) with reduced physical, sensory or mental capabilities, or lack of experience and knowledge, unless they have been given supervision or instruction concerning use of the appliance by a person responsible for their safety.**
- **Children should be supervised to ensure that they do not play with the appliance.**