







ASSEMBLY INSTRUCTIONS

Dimensions : 48"W x 36"D x 30"H

Item No : F2614 / F2616

Description : TABLE

No	LIST OF PARTS	Q'TY
1	Table Top 	1pc
2	Table Leg 	4pcs

No	LIST OF HARDWARE	Q'TY
A	Bolt 	Ø5/16" x 63.5mm 8pcs
B	Lock Washer 	Ø5/16" x 13D x 1.1mm 8pcs
C	Flat Washer 	Ø5/16" x 22D x 2mm 8pcs
D	Allen wrench 	58 x 4mm 1pc

STEP 1

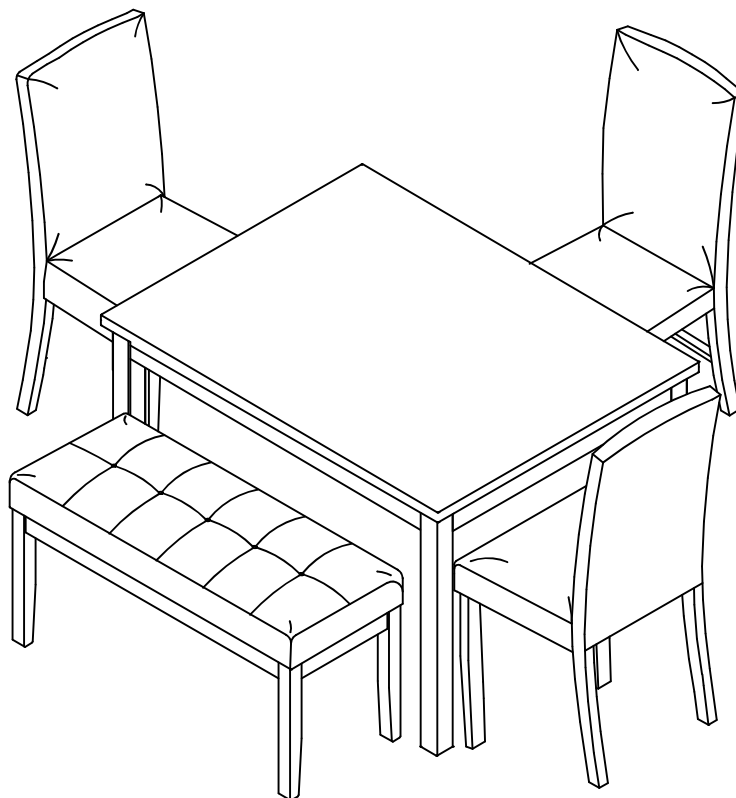
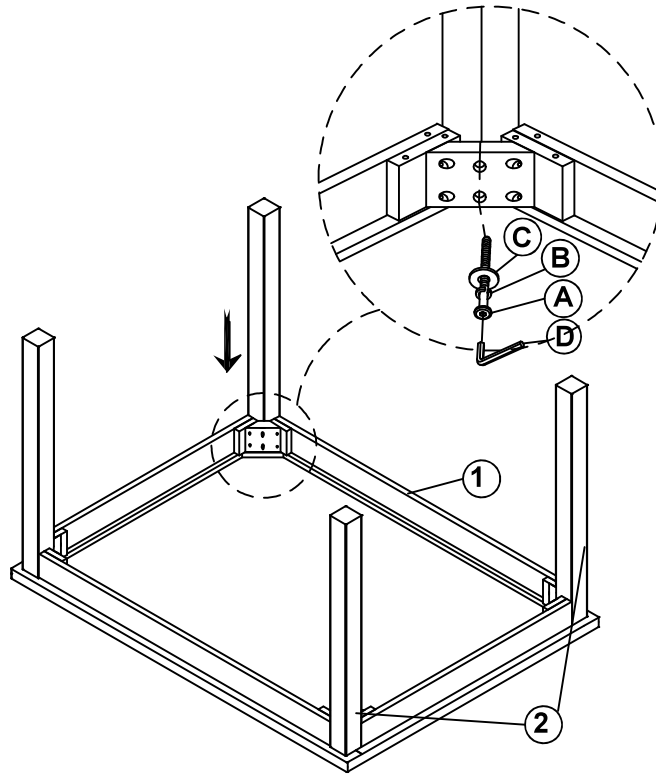









ASSEMBLY INSTRUCTIONS

Dimensions : 18"W x 21"D x 38"H

Item No : F2614 / F2616

Description : CHAIR

No	LIST OF PARTS	Q'TY
1	Chair Back 	1pc
2	Seat Cushion 	1pc
3	Front Leg 	2pcs

No	LIST OF HARDWARE	Q'TY
A	Bolt  Ø1/4" x 50mm	5pcs
B	Bolt  Ø1/4" x 75mm	4pcs
C	Lock Washer  Ø1/4" x 10D x 1.1mm	9pcs
D	Flat Washer  Ø1/4" x 22D x 2mm	9pcs
E	Allen wrench  58 x 4mm	1pc

STEP 1

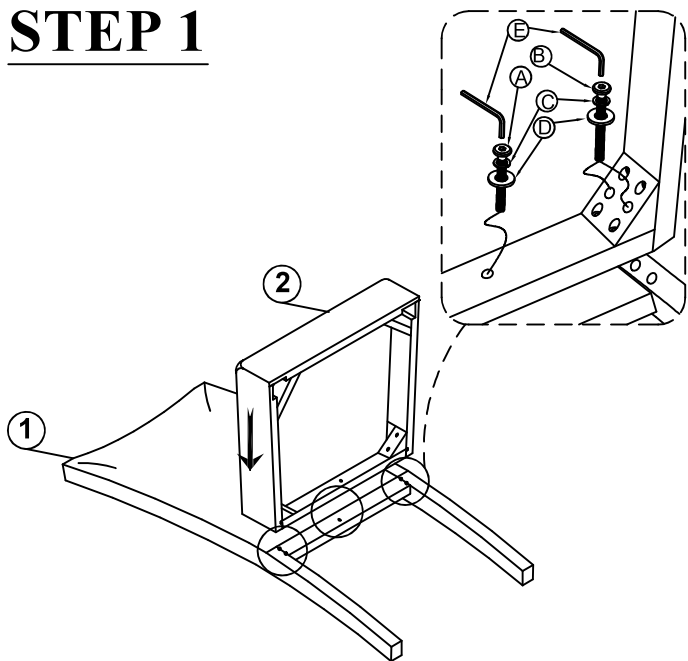

STEP 2

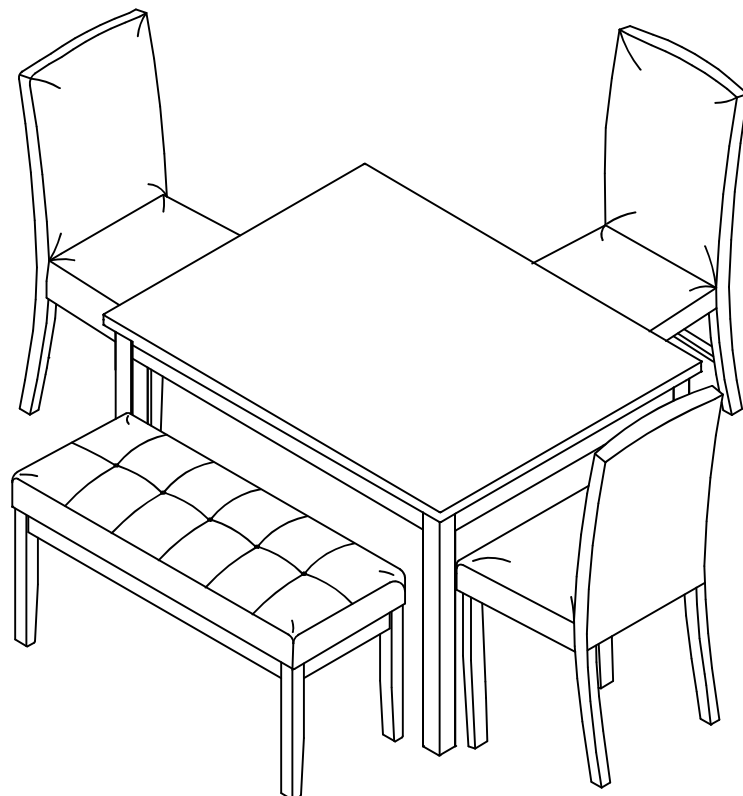
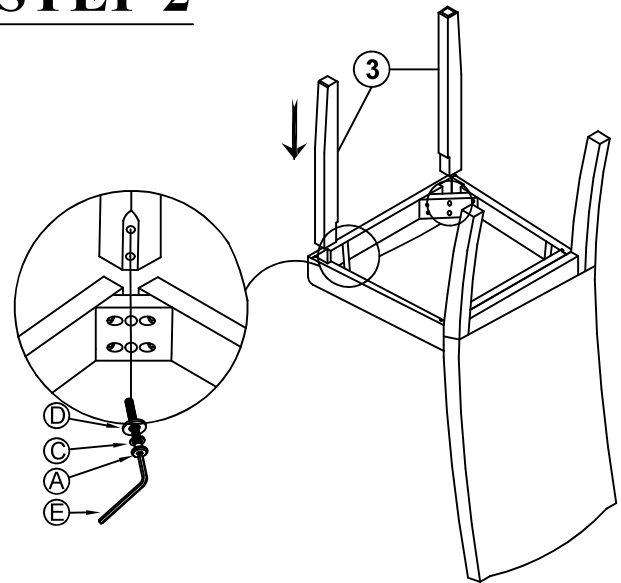





ASSEMBLY INSTRUCTIONS

Dimensions : 36"W x 16"D x 19"H

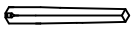
Item No : F2614 / F2616

Description : BENCH

No	LIST OF PARTS	Q'TY
1	Seat Frame 	1pc
2	Bench Leg 	4pcs

No	LIST OF HARDWARE	Q'TY
A	Bolt 	Ø5/16" x 63.5mm 8pcs
B	Lock Washer 	Ø5/16" x 13D x 1.1mm 8pcs
C	Flat Washer 	Ø5/16" x 22D x 2mm 8pcs
D	Allen wrench 	58 x 4mm 1pc

STEP 1

