

Top View

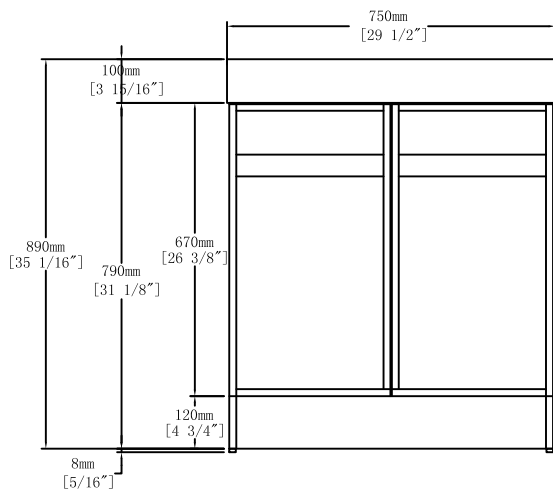

Front View

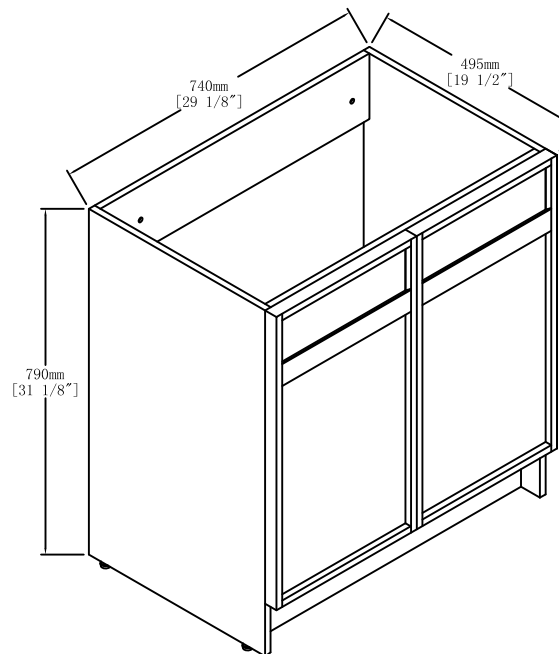
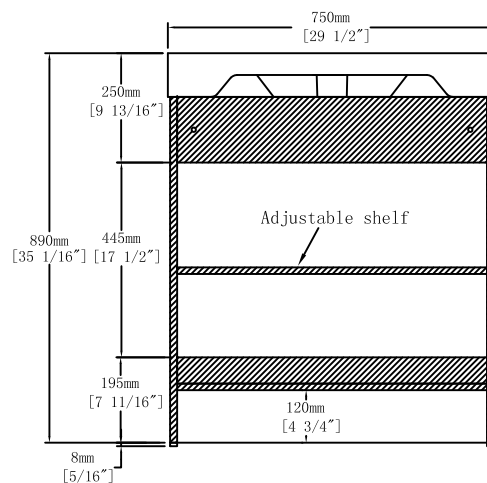

Back View

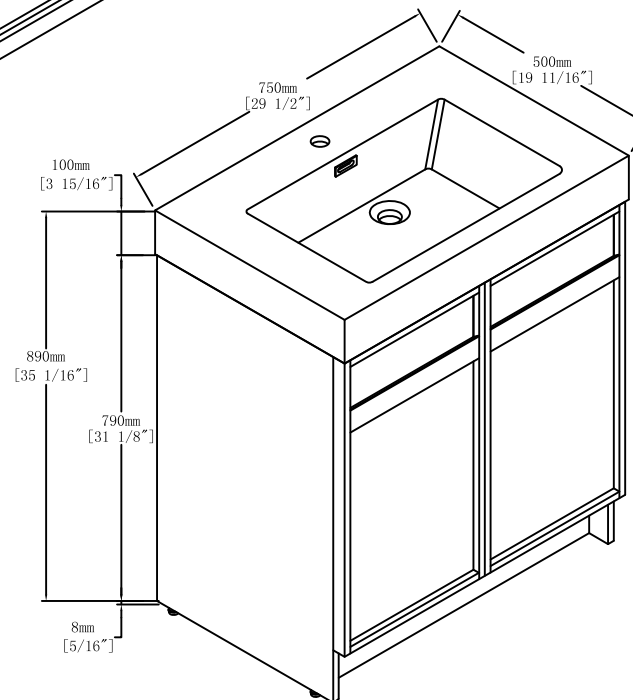

Item NO.

BV C11130

Version

V1

Project

Date

2024-10-2