

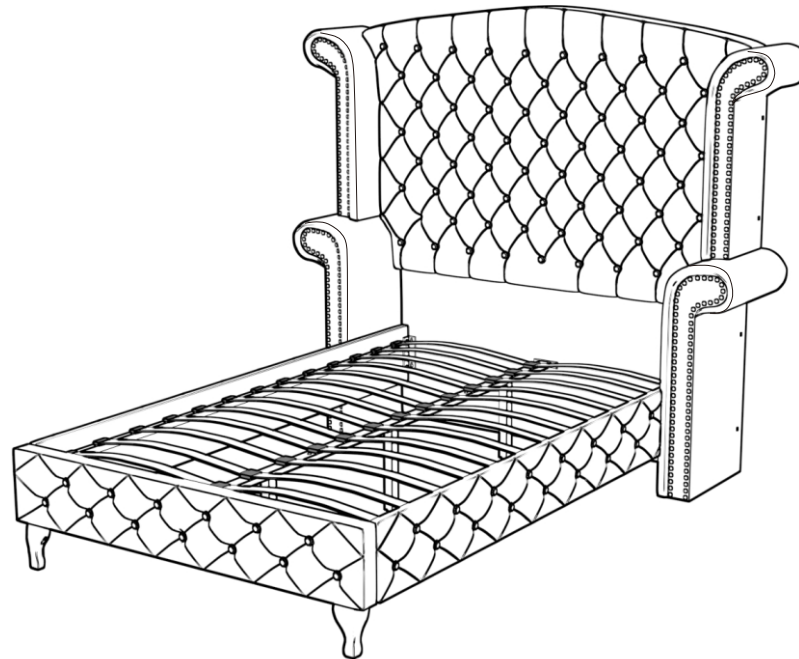





# ASSEMBLY INSTRUCTION

Thank you for purchasing this quality product. Be sure to check all packing material carefully for small parts which may have come loose inside the carton during shipment. Separate, identify and count all parts and metal hardware. Compare with parts list to be sure all parts are present. If any part(s) are missing or damaged, please contact your local furniture dealer. For efficient and speedy service, please indicate the model number and code letter of part(s) needed.

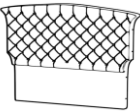
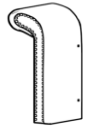
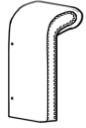
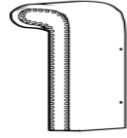
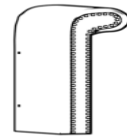
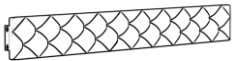
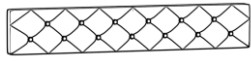



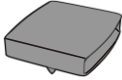

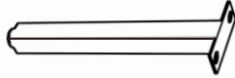
**\*\*\* Do not fully tighten screws until fully assembled \*\*\***



## PARTS LIST

 <b>A</b> HEADBOARD CUSHION x1	 <b>BL</b> HEADBOARD LIFT WING x1	 <b>BR</b> HEADBOARD RIGHT WING x1	 <b>C</b> HEADBOARD LIFT LEG x1	 <b>D</b> HEADBOARD RIGHT LEG x1
 <b>E</b> SIDE RAIL x2	 <b>F</b> FOODBOARD CUSHION x1	 <b>G</b> CONNECTING LINK x1	 <b>H</b> SLATS x26	 <b>I</b> SLATS BUCKLE x26
 <b>J</b> SLATS BUCKLE x13	 <b>K</b> FOODBOARD LEG x2	 <b>L</b> SUPPORT LEG x3		

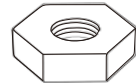
## HARDWARE LIST

 <b>1</b> JCBC 5/16"x50mm x10	 <b>2</b> JCBC 5/16"x30mm x18	 <b>3</b> SPRING WASHER 5/16"x12mm x10	 <b>4</b> WASHER 5/16"x19mm x28	 <b>5</b> NUT 5/16"x12mm x6
 <b>6</b> Allen Wren M5x40mmx100mm x1	 <b>7</b> Wrench x1			

### Step1

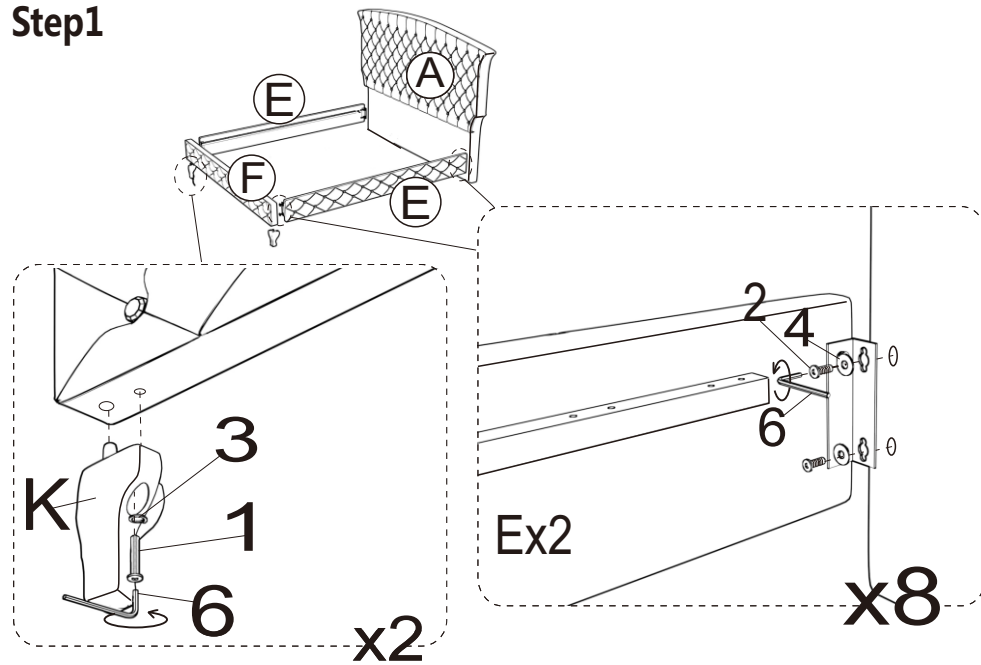

### Step2

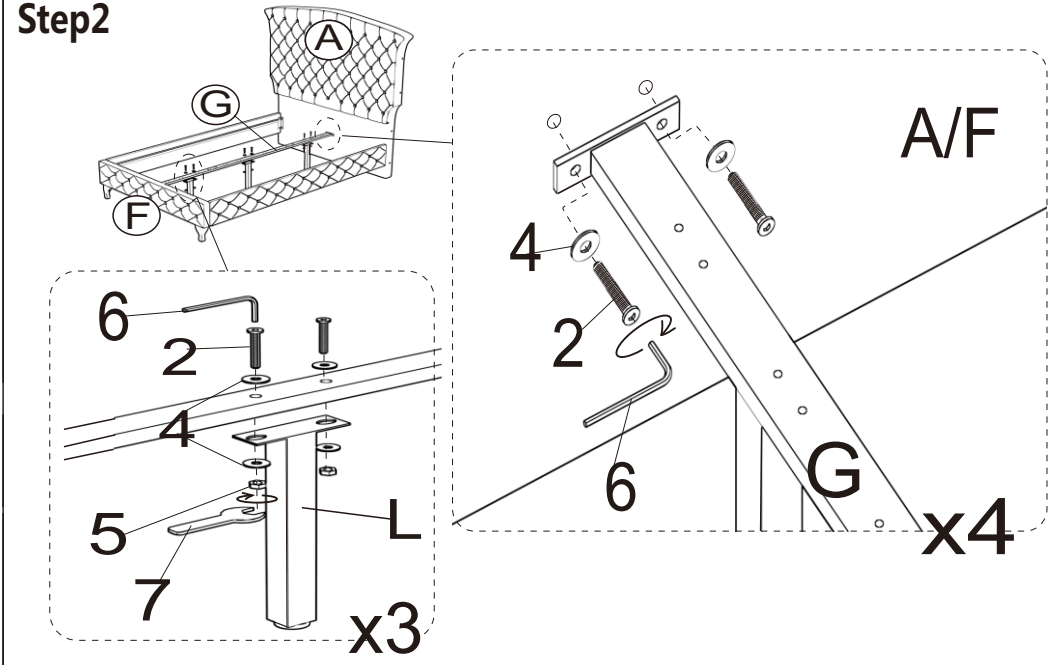

### Step3

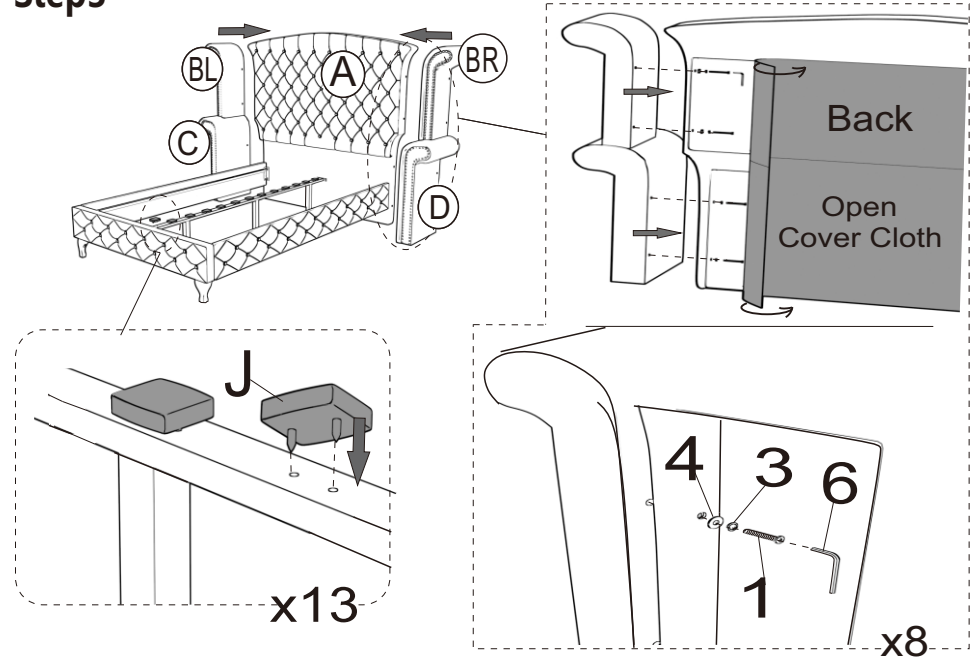

### Step4

