

ASSEMBLY INSTRUCTION

025 -313 OAKMONT 5/0 UPH PANEL HEADBOARD

025 -316 OAKMONT 6/6 UPH PANEL HEADBOARD

www.kincaidfurniture.com



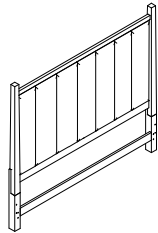



Phone : 828-728-3261.

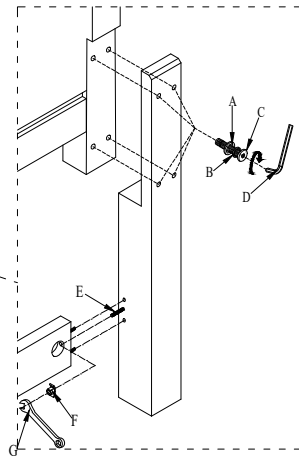
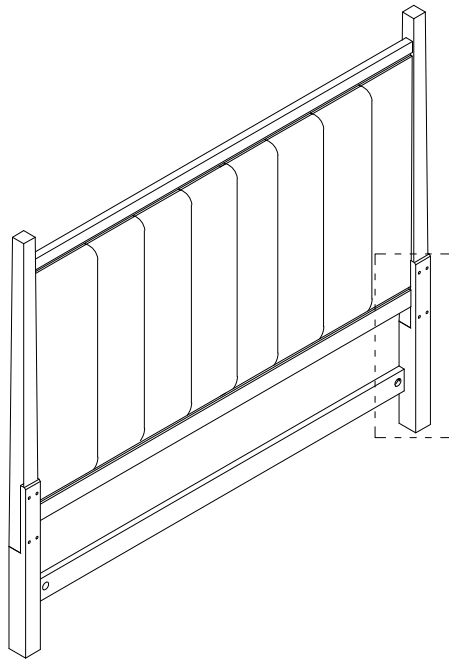

IMPORTANT NOTES :

- . Place all wooden parts on a clean and smooth surface such as a rug or carpet to prevent the parts from being scratched.
- . Check to be sure that you have all parts and hardware.
- . Remove all wrapping materials, including staples and packing straps before you start to assemble.
- . Do not tighten all screws and bolts until completely assembled.
- . Keep all hardware out of the reach of children.



NO.	PART DESCRIPTION	Q'TY
A	 FLAT WASHER 5/16"*19	8pcs
B	 LOCK WASHER 5/16"	8pcs
C	 BOLT 5/16"*44mm	8pcs
D	 ALLEN KEY 4mm	1pc
E	 THREAD ROD (5/16"*88mm)	2pcs
F	 CURVED SLOTTED WASHER (5/16")	2pcs
G	 WRENCH (12mm)	1pc

ASSEMBLY INSTRUCTION

025-307 6/6 PANEL FOOTBOARD W/RAIL+SLAT

www.kincaidfurniture.com



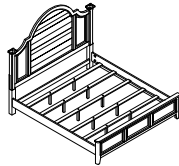
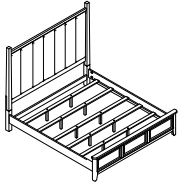

Phone : 828-728-3261.

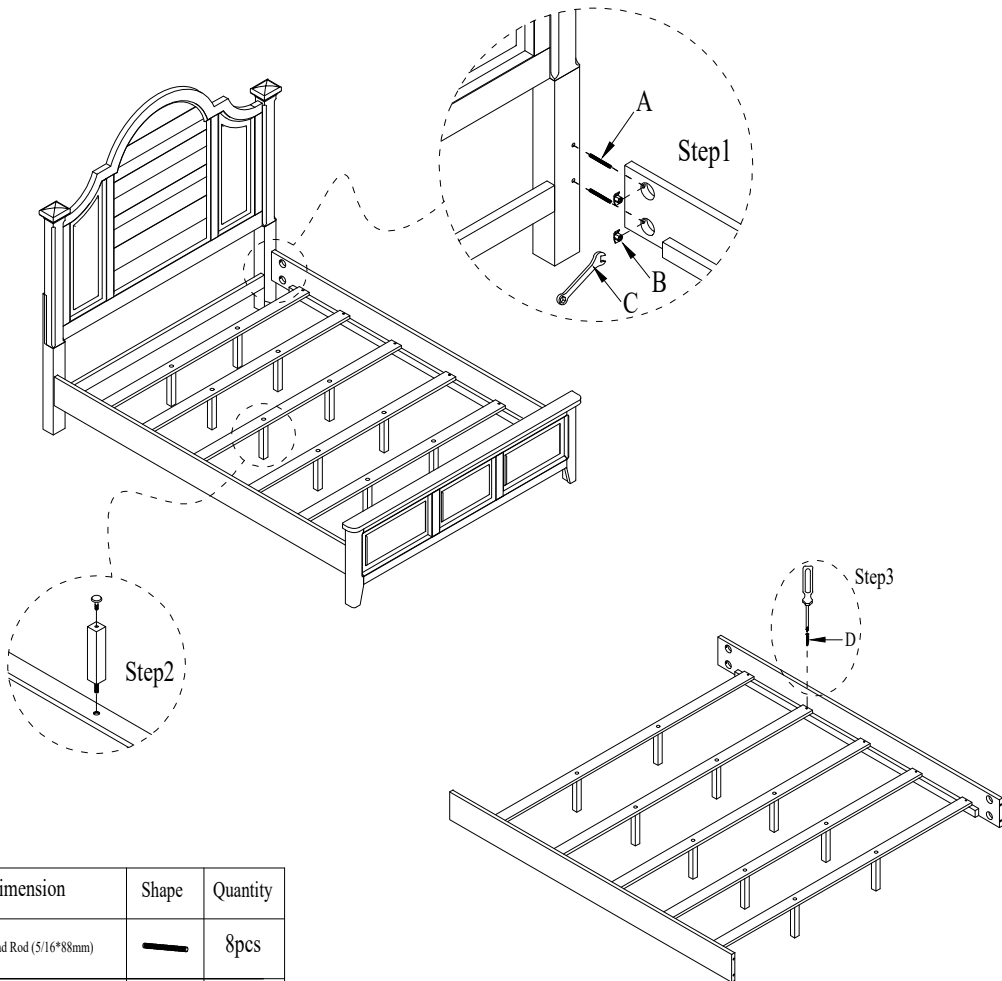

IMPORTANT NOTES :

- . Place all wooden parts on a clean and smooth surface such as a rug or carpet to prevent the parts from being scratched.
- . Check to be sure that you have all parts and hardware.
- . Remove all wrapping materials, including staples and packing straps before you start to assemble.
- . Do not tighten all screws and bolts until completely assembled.
- . Keep all hardware out of the reach of children.



No.	Dimension	Shape	Quantity
A	Thread Rod (5/16*88mm)		8pcs
B	Curved Slotted Washer (5/16")		8pcs
C	Wrench (12mm)		1pc
D	SCREW (8*25mm)		10pcs