

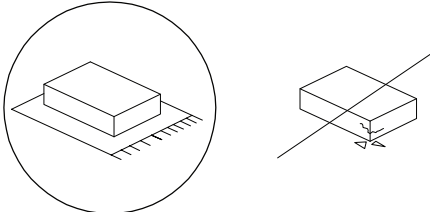

		<p>30'</p>
		
		<p>1</p>

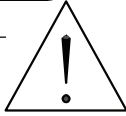

H

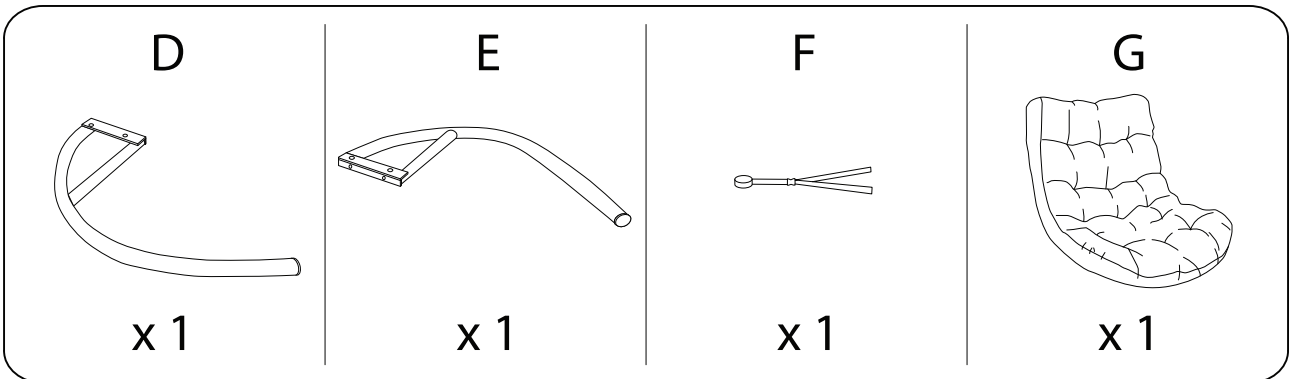
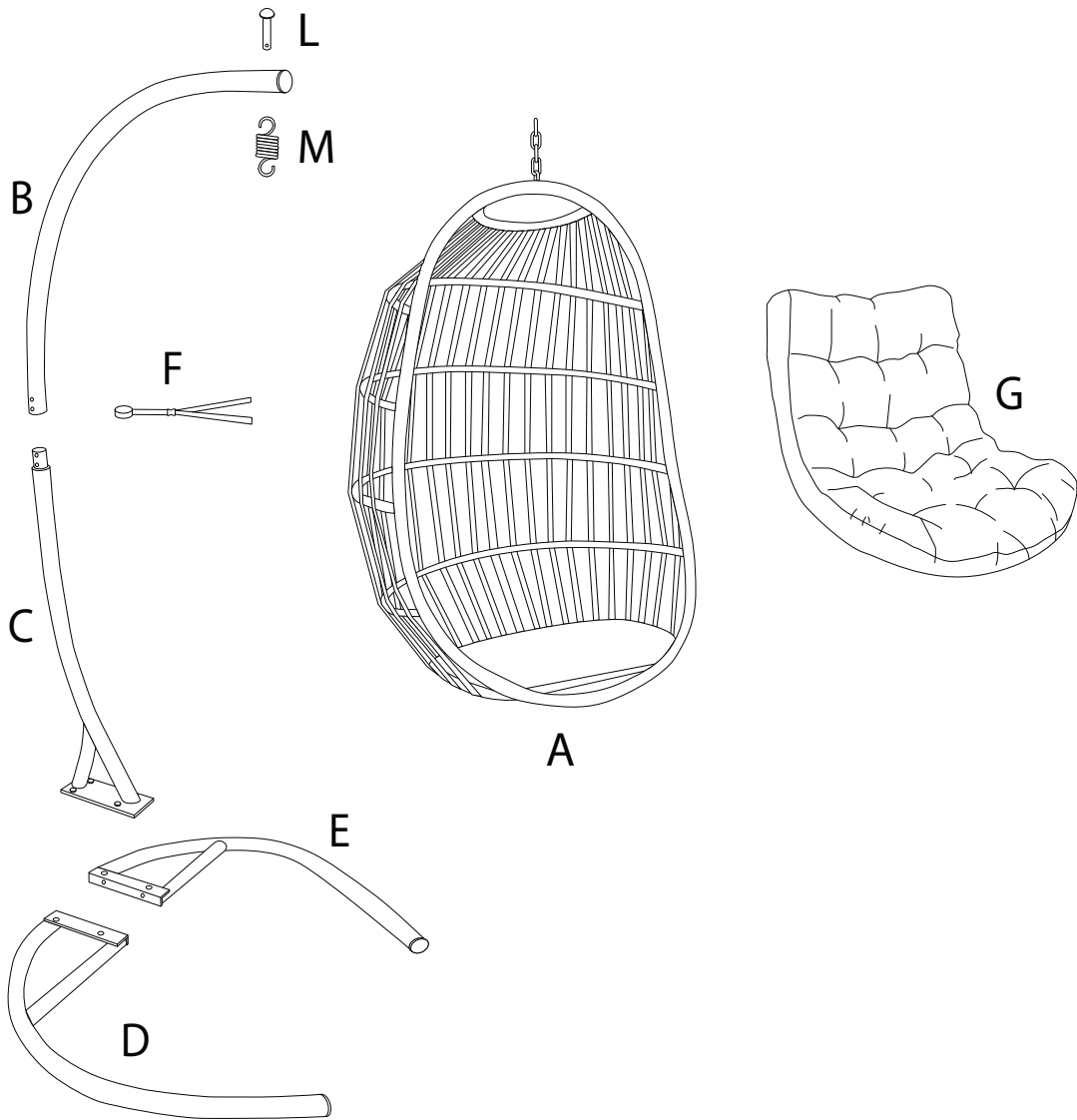
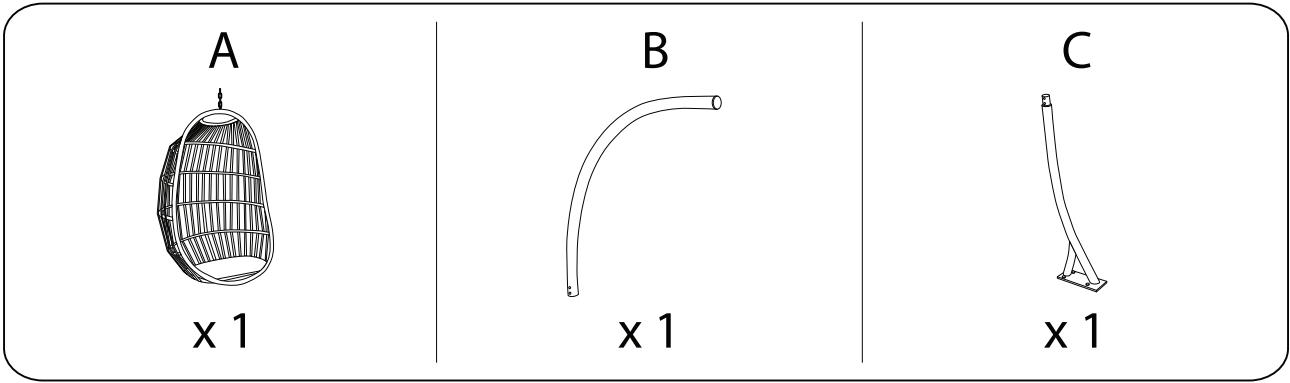
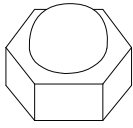

x 2

I

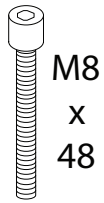

x 2

J

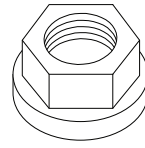

x 6

K



x 6

L



x 1

M



x 1

N

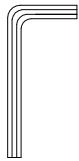

x 1

O

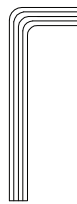

x 1

P

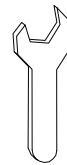

x 1

1

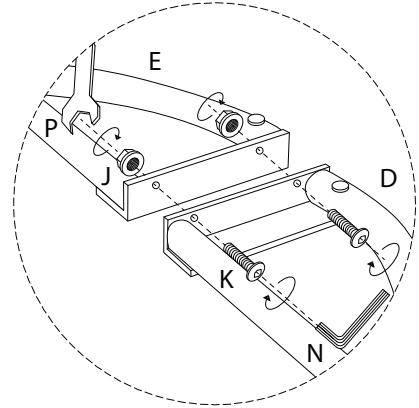
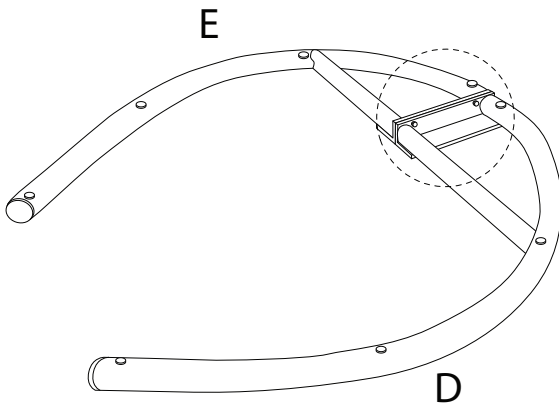
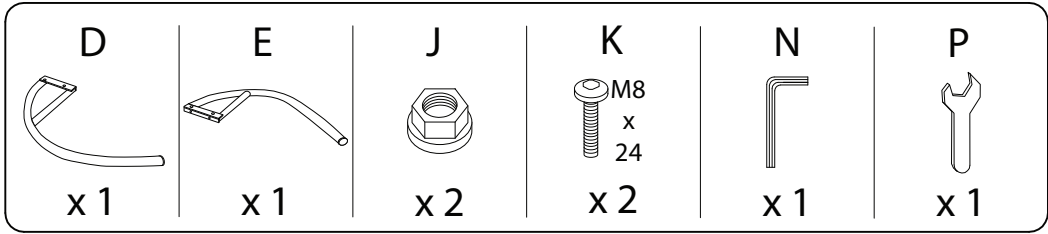

2

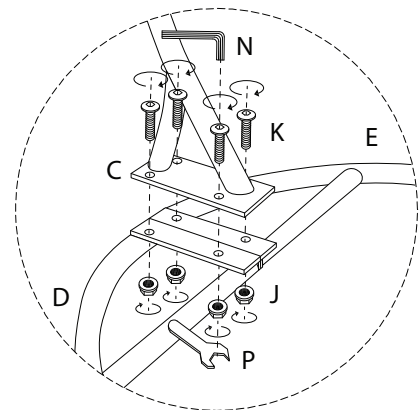
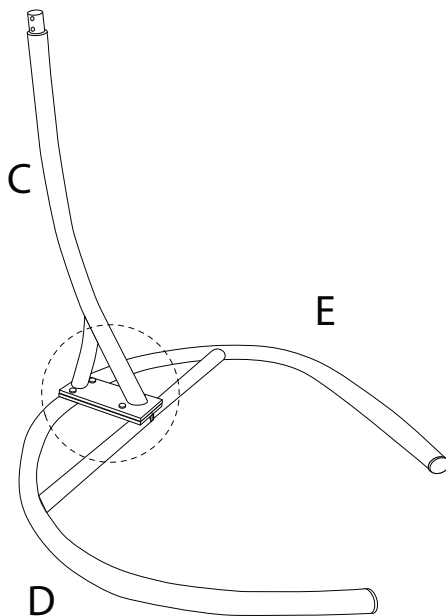
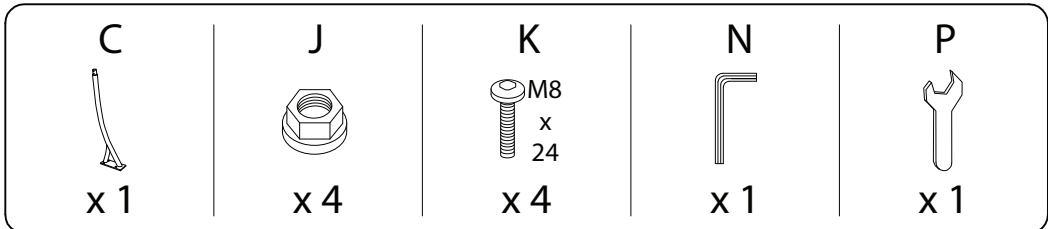

3

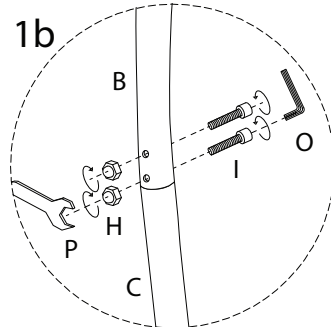
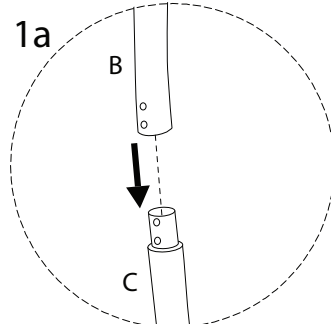
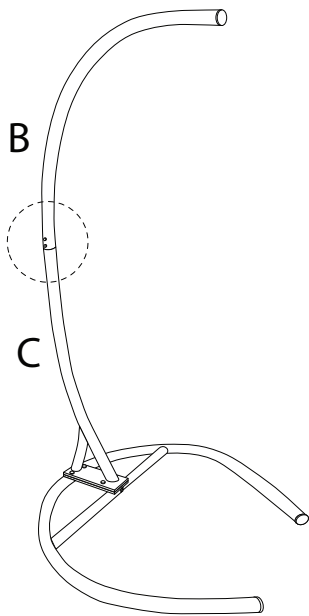
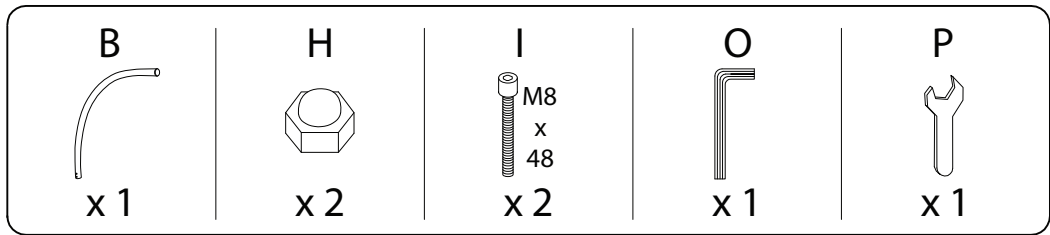

4

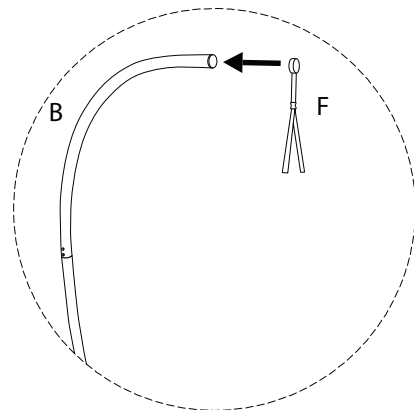
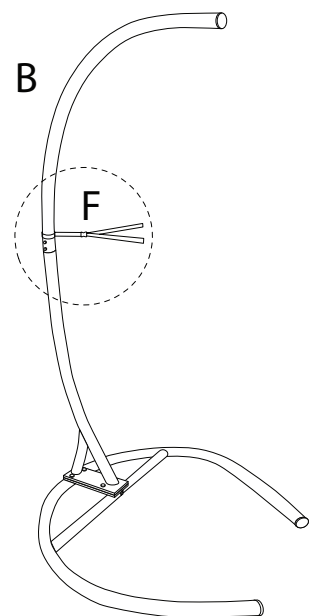
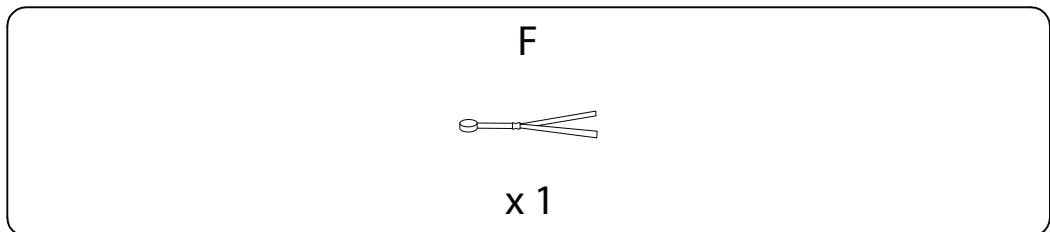

5

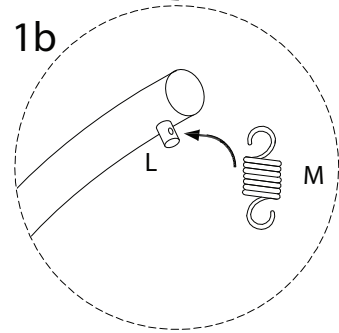
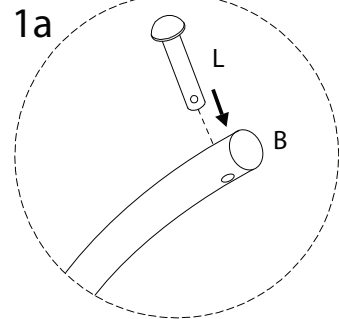
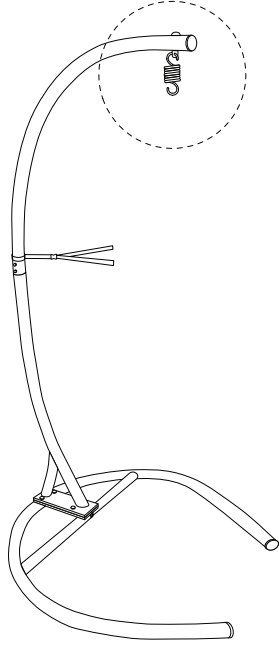
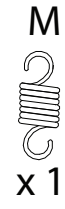

6

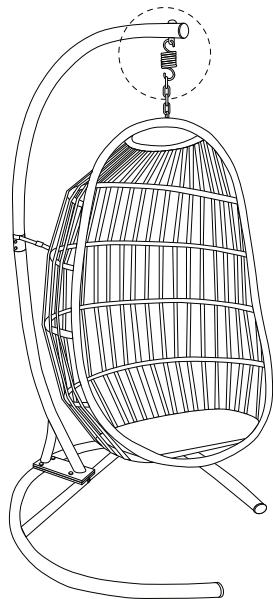

A

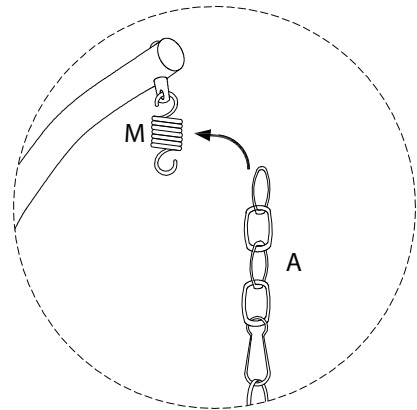

7

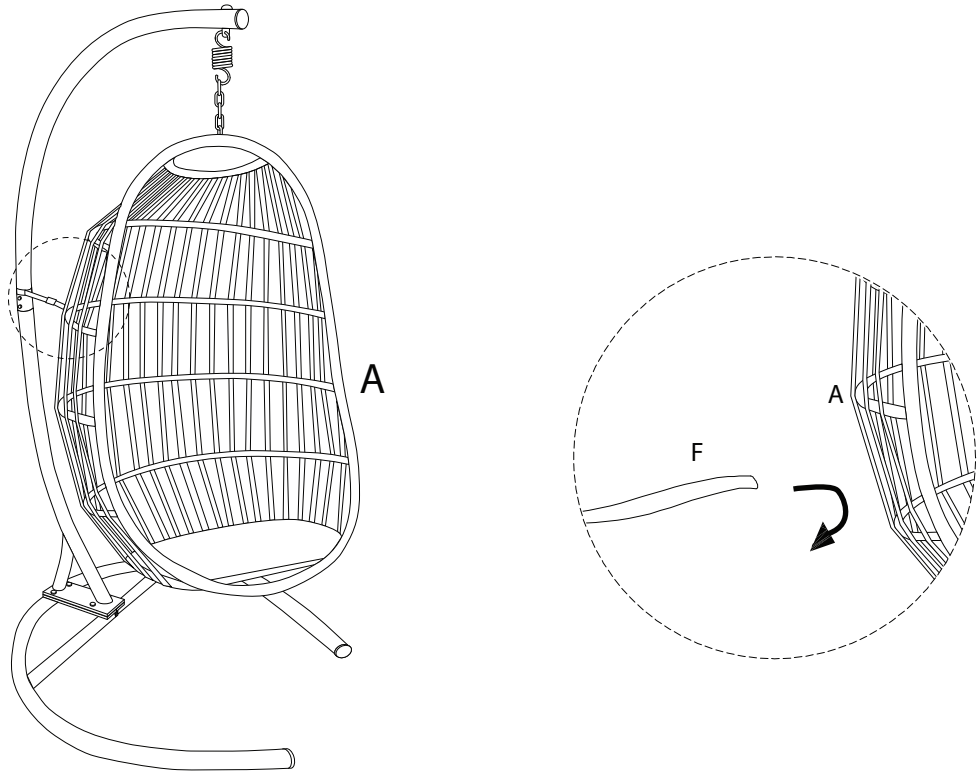

8

