

QUEEN BED ASSEMBLY INSTRUCTION

Thank you for purchasing this quality product. Be sure to check all packing material carefully for small parts which may have come loose inside the carton during shipment. Separate, identify and count all parts and hardware. Compare with the parts list to be sure all parts are present.

IMPORTANT : PLEASE READ INSTRUCTION BEFORE STARTING THE ASSEMBLY.

"DO NOT TIGHTEN SCREWS UNTIL COMPLETELY ASSEMBLED"

"DO NOT OVERTIGHT ANY HARDWARE"

WARNING : SMALL PARTS AND HARDWARE NOT FOR CHILDREN UNDER 3 YEARS. ADULT ASSEMBLY REQUIRED.

TABLE OF CONTENTS

HARDWARES LIST	PAGE 2
PARTS LIST	PAGE 3 - 4
PARTS' LOCATION	PAGE 5
ASSEMBLY STEPS	PAGE 6 - 10

ASSEMBLY TOOLS REQUIRED

1.Screwdriver (not provide)

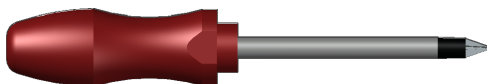

2.Hammer (not provide)

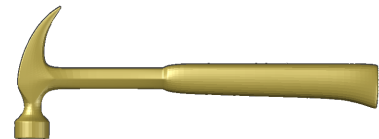





Skip the power drill this time.



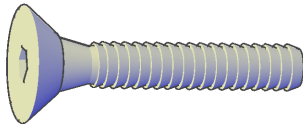
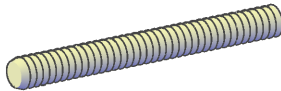
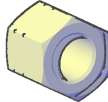

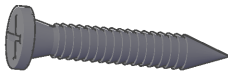
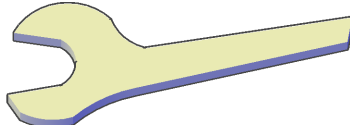
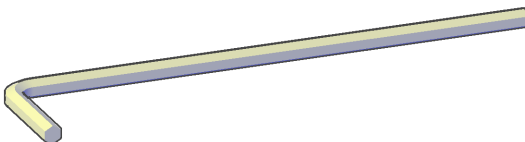
ASSEMBLY INSTRUCTION

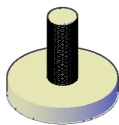
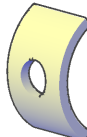
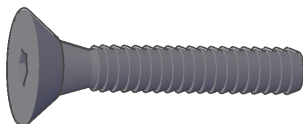
HARDWARES LIST

ITEM	DESCRIPTION	DRAWING	QTY
A	JCBC SCREW M6 x 40 MM		8 PCS
B	STUD BOLT M6 x 60 MM		12 PCS
C	HEX NUT M6		12 PCS
D	BEND WASHER Ø7.5 MM		12 PCS
E	CSK SCREW M4 x 25 MM		8 PCS
F	SPANNER 10 MM (M6)		1 PC
G	M4 ALLEN KEY		1 PC
H	M6 x 19 MM FLAT WASHER		14 PCS
I	M6 x 12 MM SPRING WASHER		14 PCS
J	SUPPORT LEG ADJUSTABLE FEET		4 PCS
K	BEND WASHER 15 X 25MM		12 PCS
L	JCBC SCREW M6 x 35 MM (BLK)		6 PCS

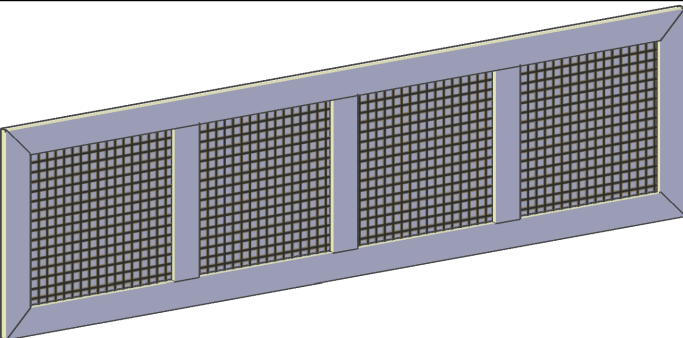
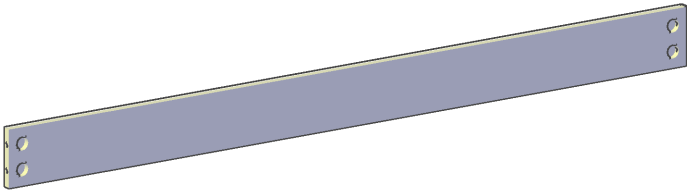
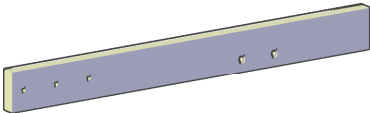
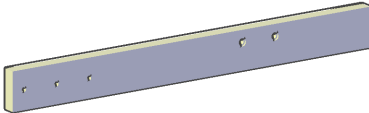

ASSEMBLY INSTRUCTION

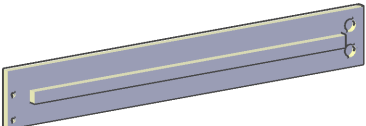
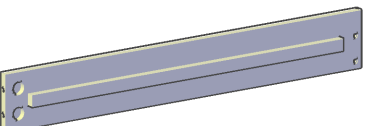
PARTS LIST

ITEM	DESCRIPTION	DRAWING	QTY
1	HEADBOARD		1 PC
2	FOOTBOARD		1 PC
3	HEADBOARD LEG (L)		1 PC
4	HEADBOARD LEG (R)		1 PC
5	FOOTBOARD LEG (L)		1 PC
6	FOOTBOARD LEG (R)		1 PC
7	SIDE RAIL (i)		2 PCS
8	SIDE RAIL (ii)		2 PCS

ASSEMBLY INSTRUCTION

PARTS LIST

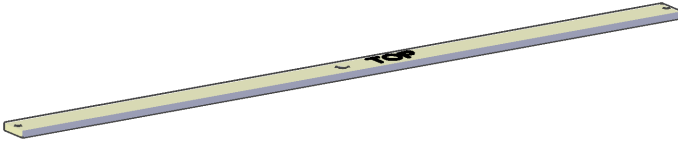
ITEM	DESCRIPTION	DRAWING	QTY
9	SIDE RAIL LEG		2 PCS
10	SUPPORT LEG		8 PCS
11	SLAT		4 PCS

ASSEMBLY INSTRUCTION

PARTS LOCATION

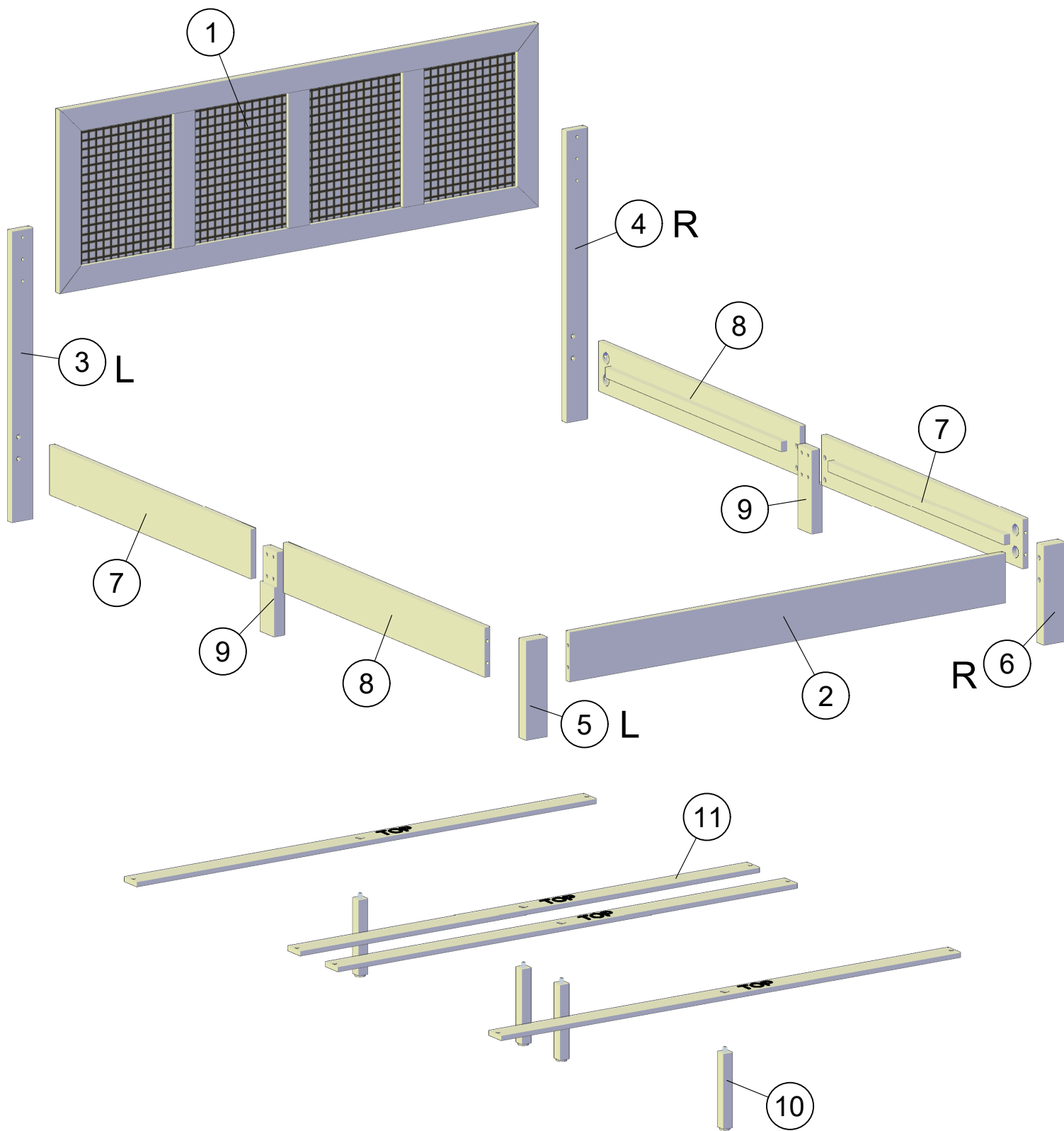

ASSEMBLY INSTRUCTION

STEP 1

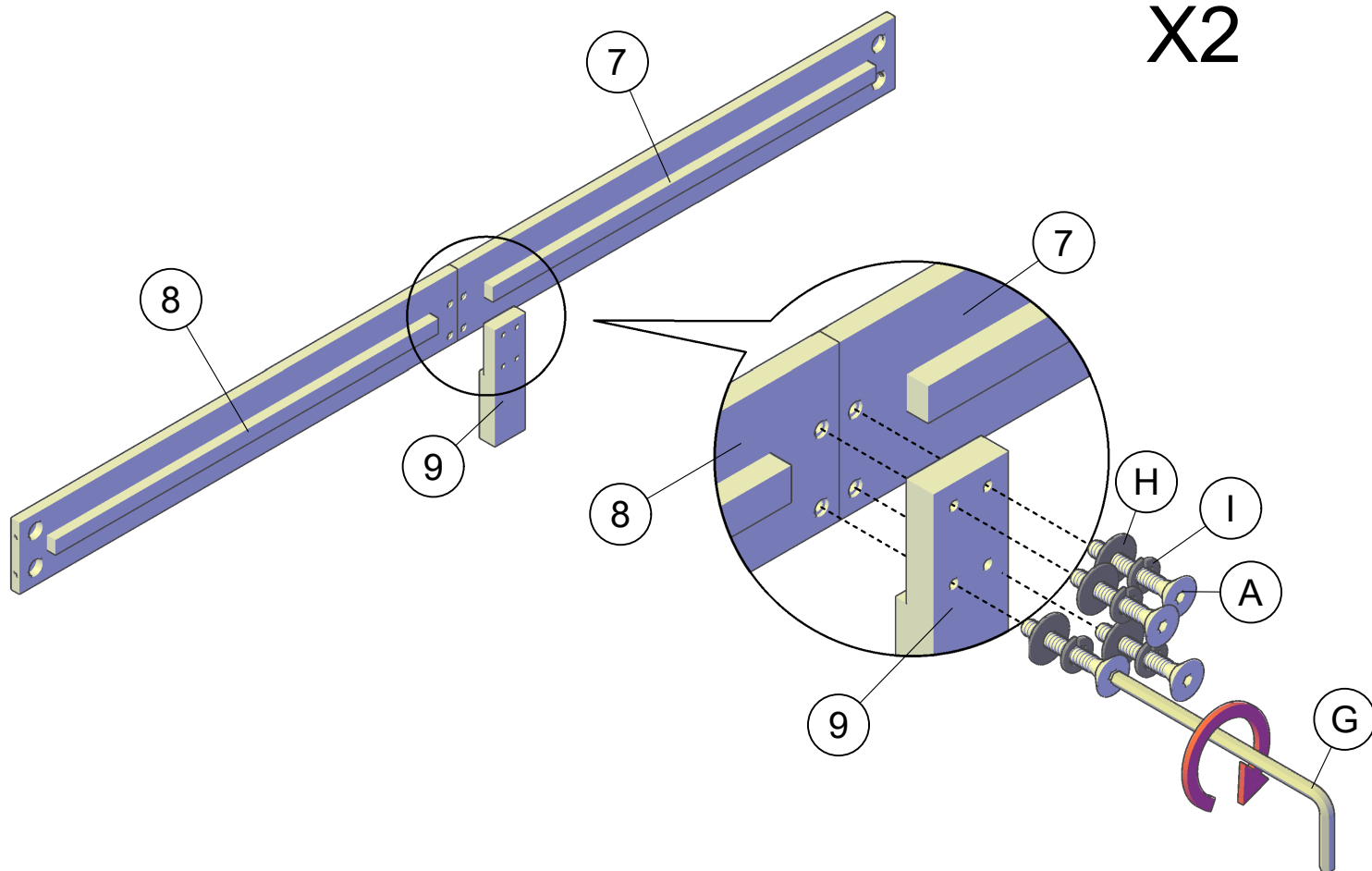

STEP 2

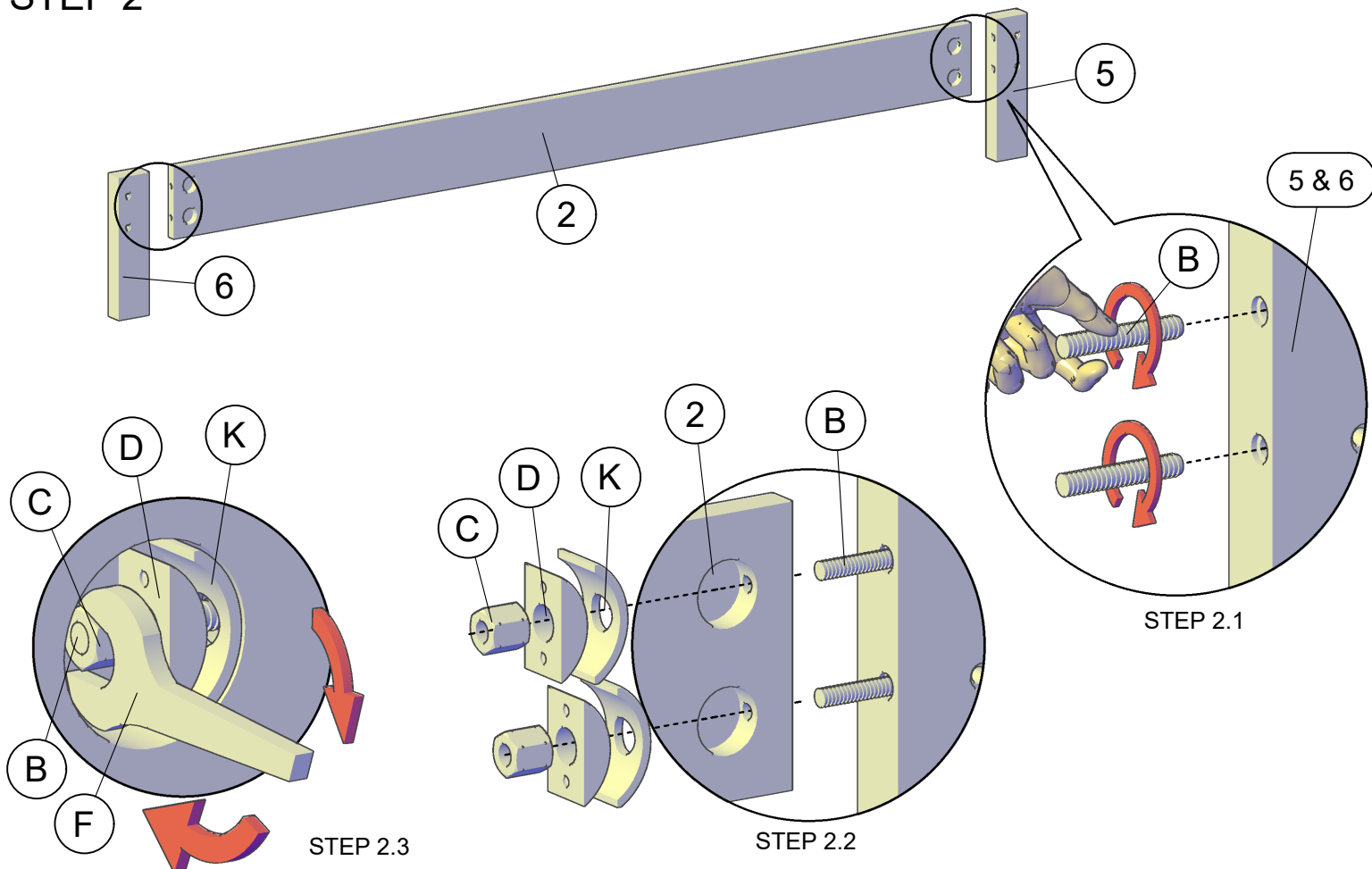

ASSEMBLY INSTRUCTION

STEP 3

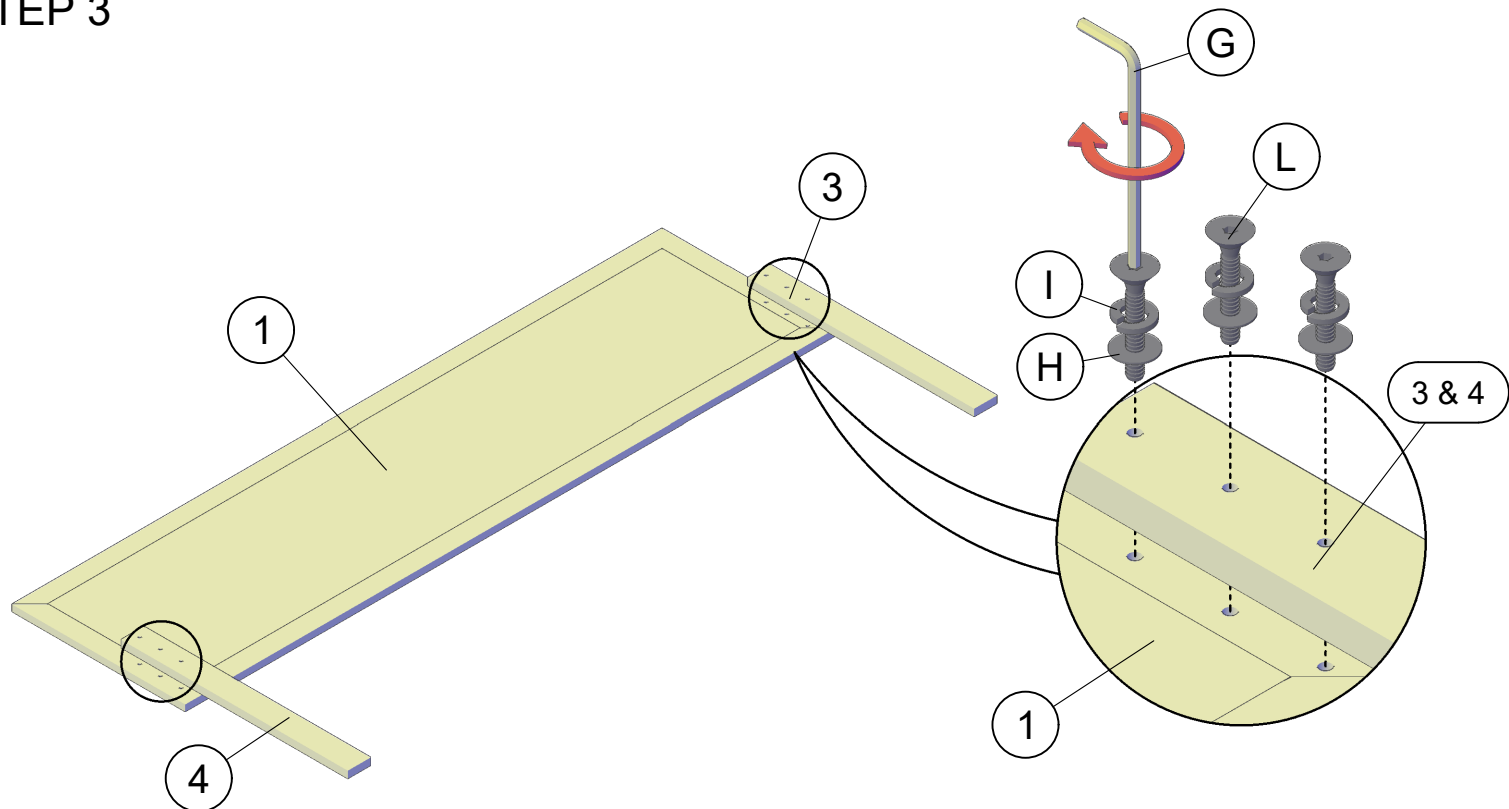

STEP 4

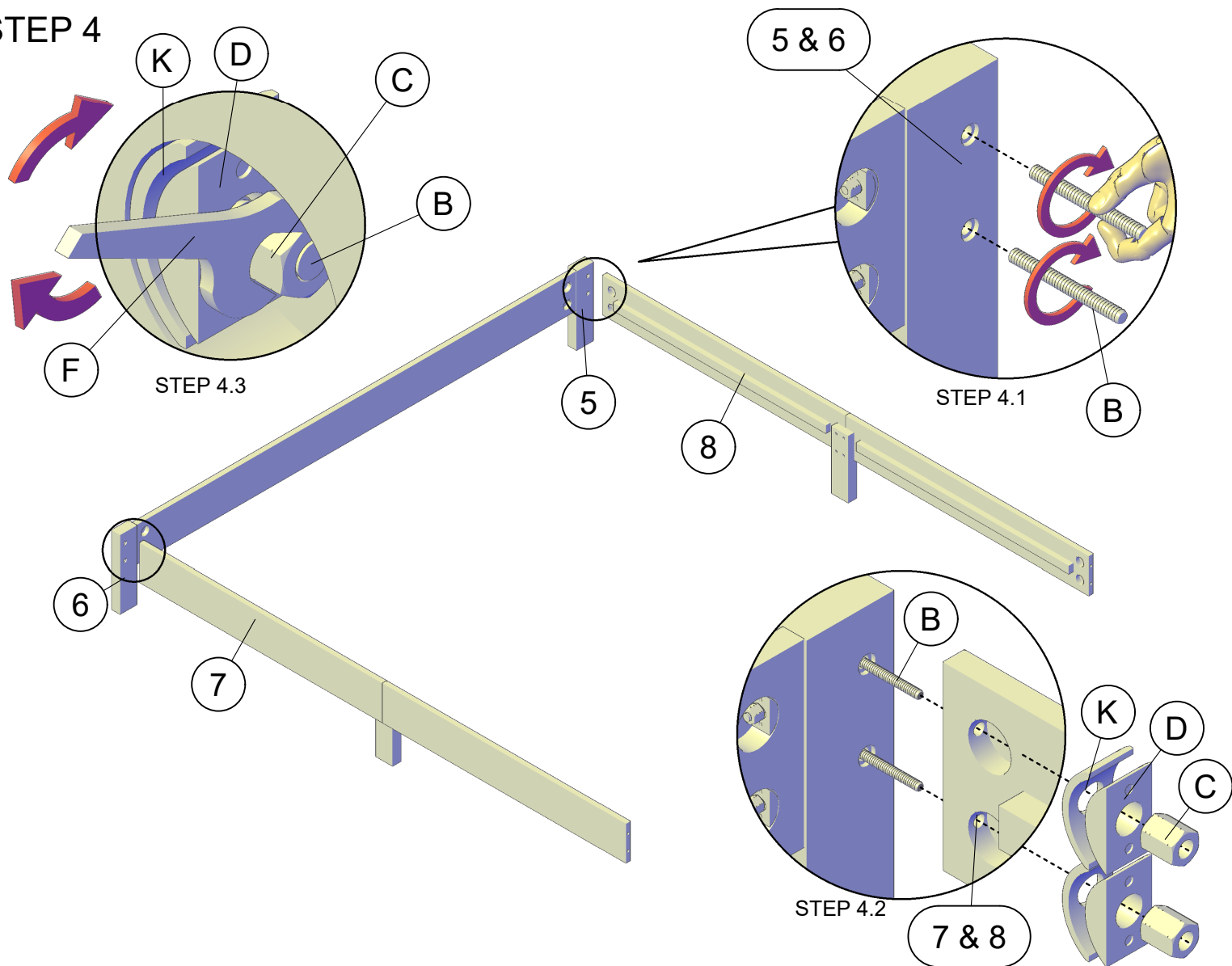

ASSEMBLY INSTRUCTION

STEP 5

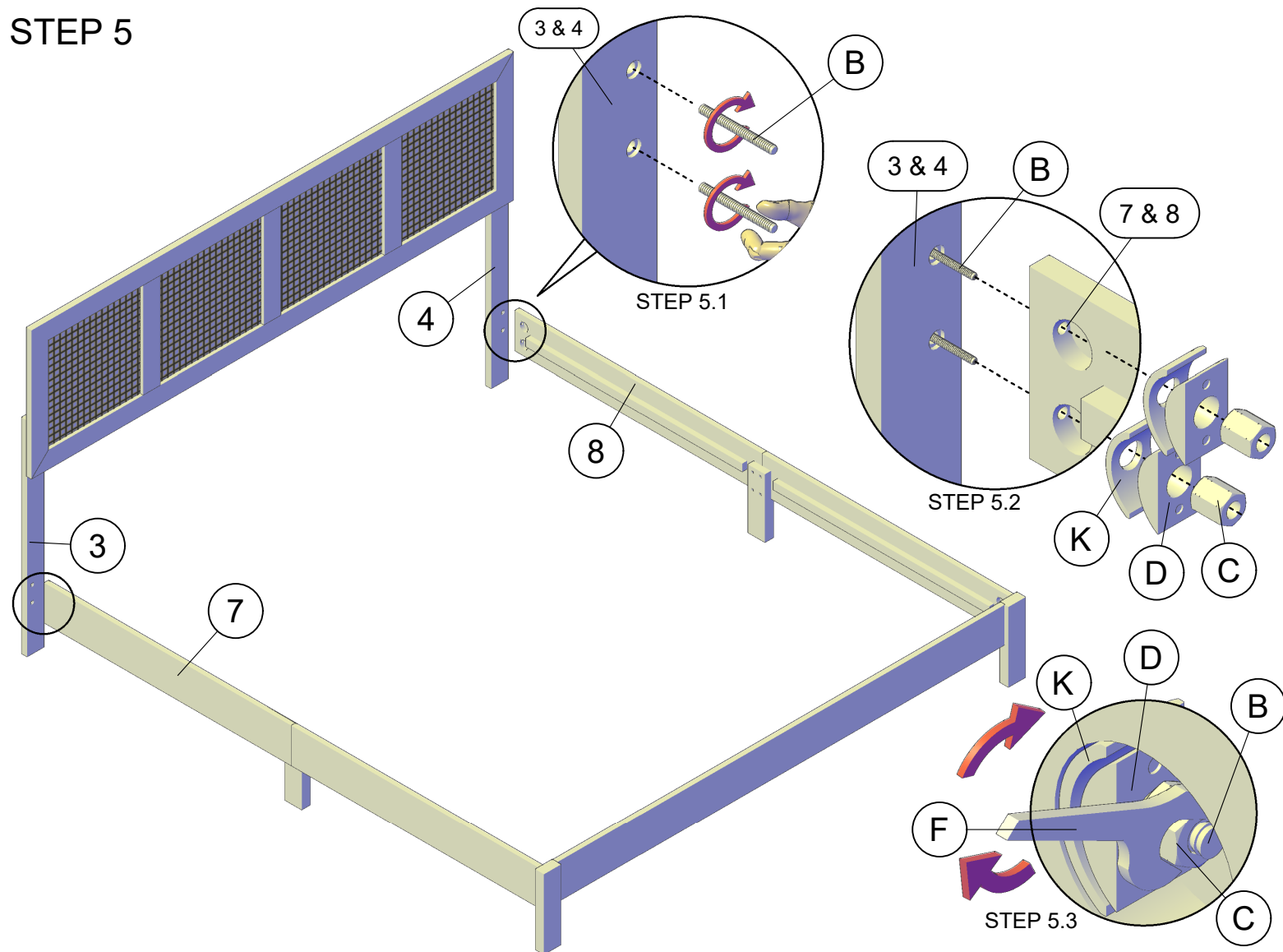

STEP 6

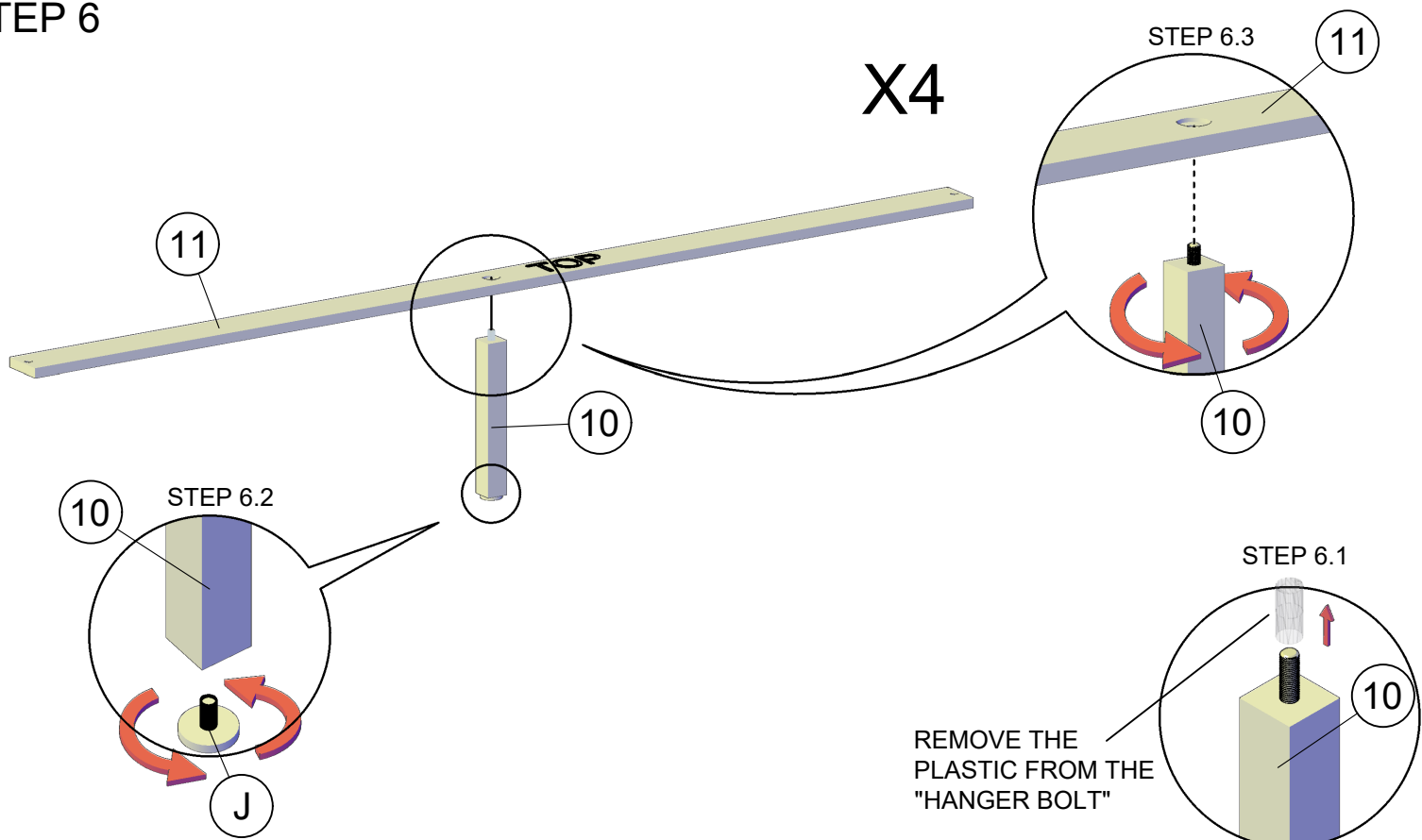

ASSEMBLY INSTRUCTION

STEP 7

Please push the side rail inward to ensure it is fully aligned with both ends of the slats.

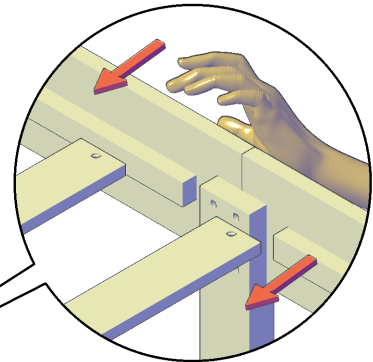
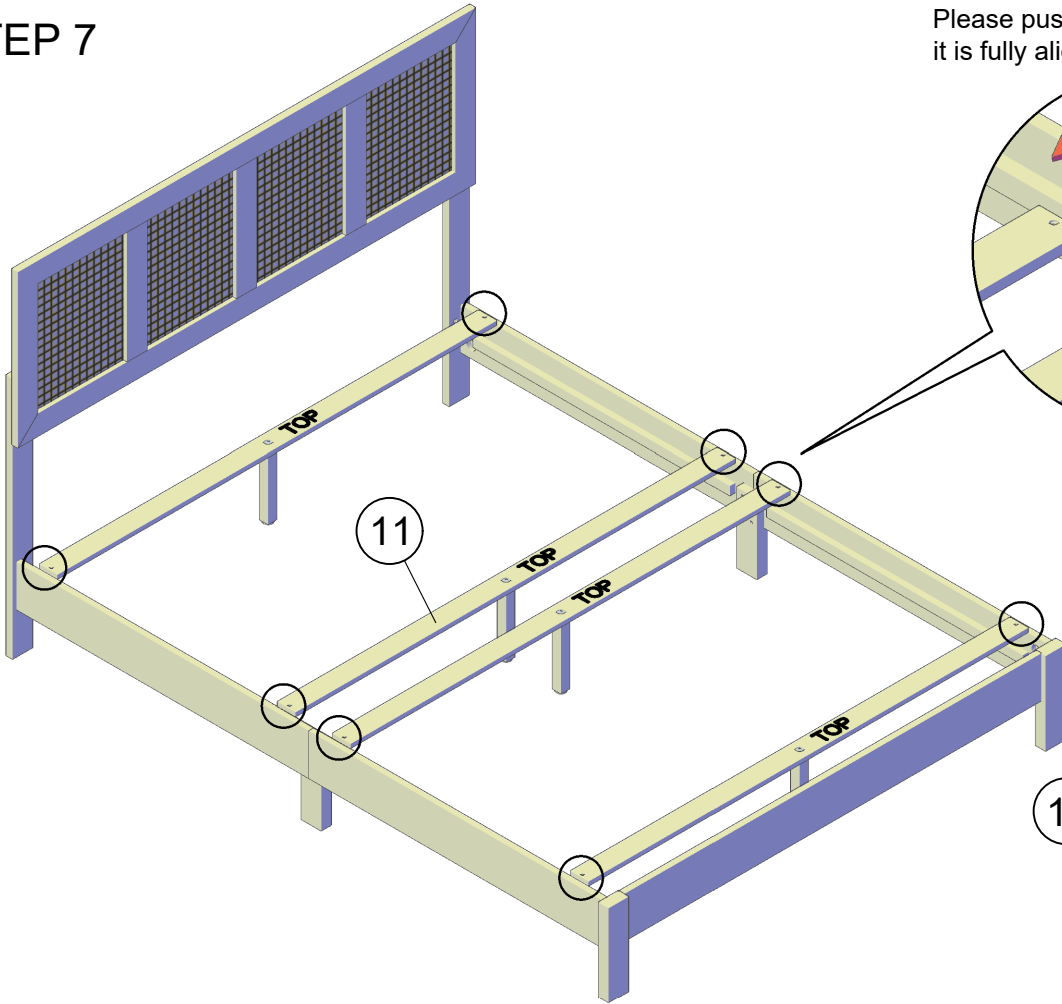

STEP 7.1

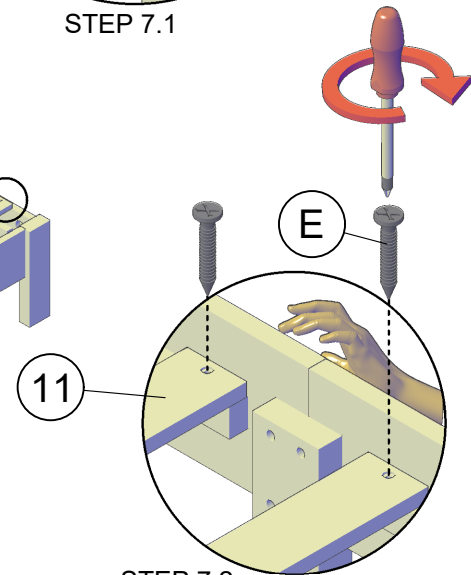

STEP 7.2

STEP 8

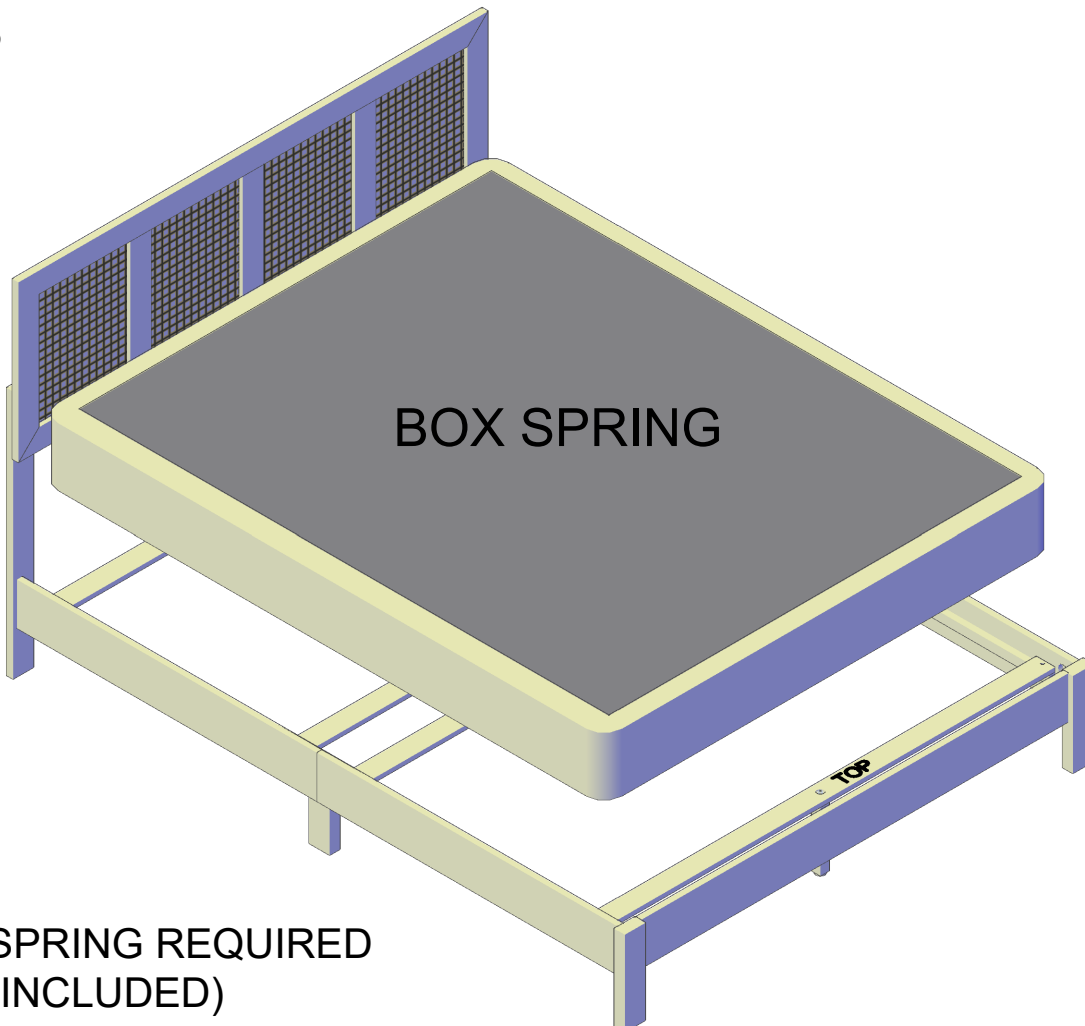

**BOX SPRING REQUIRED
(NOT INCLUDED)**

ASSEMBLY INSTRUCTION

STEP 9

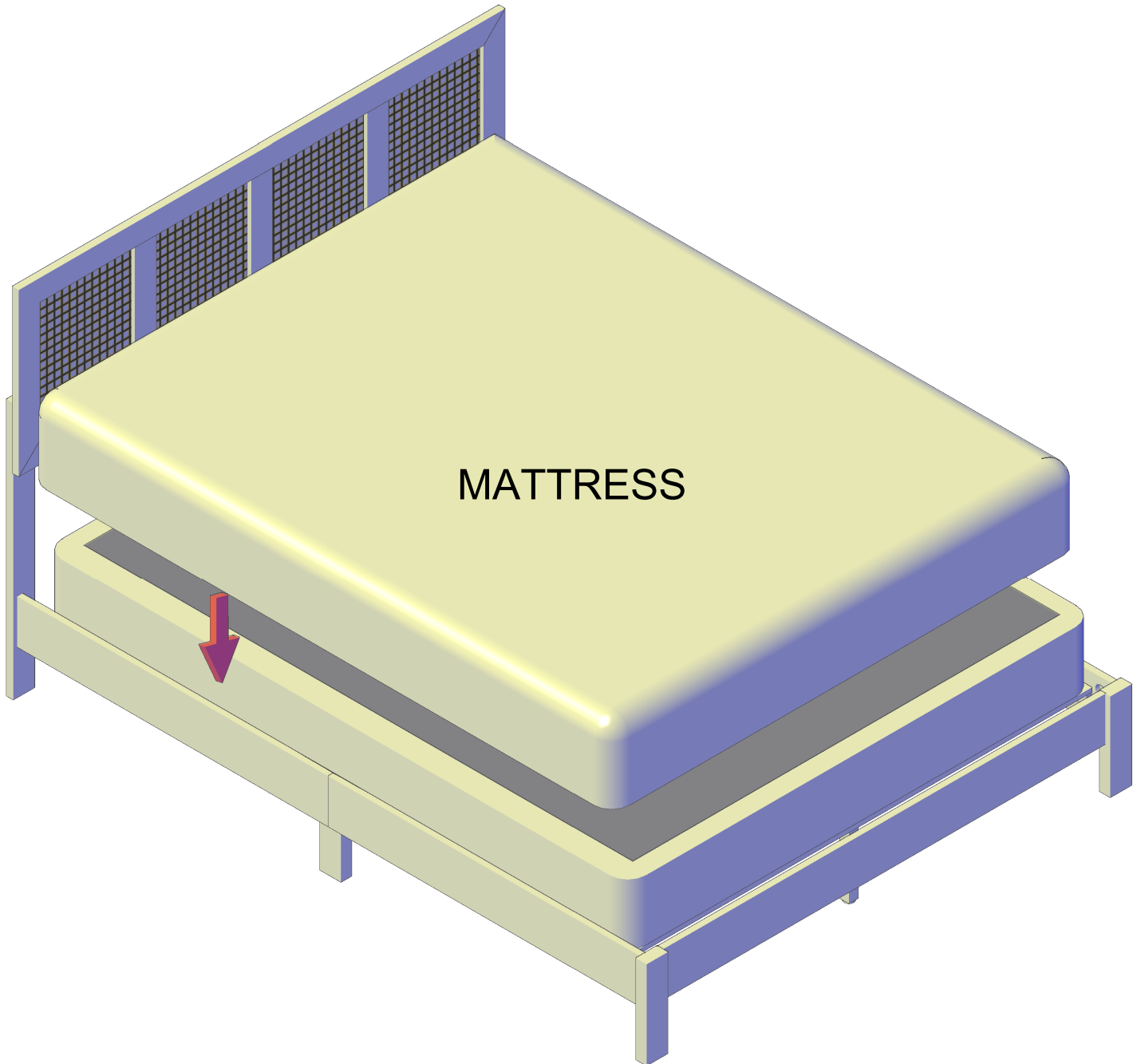

MATTRESS NOT INCLUDED

ASSEMBLY
COMPLETE