

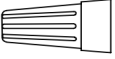





# Assembly Instructions

Maeve Chandelier  
56004209

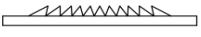
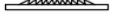
## Parts and Tools

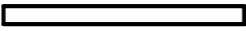
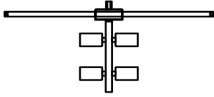
Z1	Wire Connector		X 3
Z2	Nut		X 1
Z3	Nut		X 2
Z4	Non Slip Washer		X 1
Z5	Non Slip Washer		X 2
A	Canopy		X 1
B	Pipe		X1
C	Pipe		X 2
D	Lamp Bracket		X 1
E	Glass Sticks		X 96

### Before beginning

- 1) Carefully unpack and position the item on a clean, non-marring surface to assemble.
- 2) Read this Assembly Instructions from beginning to end before starting to assemble.
- 3) Take an inventory of the required parts to ensure all are available.
- 4) To prevent accidental choking hazards, keep all packing materials away from small children.
- 5) Only tighten hardware until ALL hardware are fully engaged on their locations. Overtighten bolts will damage the bolt threads.
- 6) Use only factory provided hardware to assemble. Unapproved hardware can damage product or jeopardize the structural integrity of the product.
- 7) The use of power tool to assemble is not recommended due to high risk of over-torque, which can damage the product.

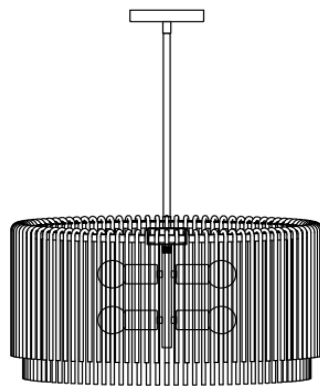

ASSEMBLY REQUIRES  
TWO PEOPLE



20 MINUTE  
ASSEMBLY TIME



KEEP INSTRUCTIONS  
FOR FUTURE USE

# Assembly Instructions

Maeve Chandelier

56004209

1

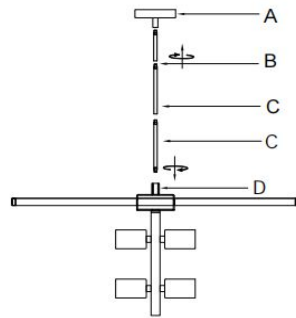

Link the tubes (B)/ (C) together ( you need to link them according the height you want), and thread the linked pipe to the screw nipple (A) and (D). (Put the cables through the pipes at the same time)

2

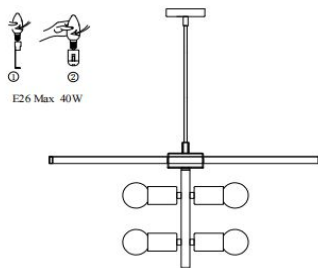

Install the bulbs, E26 Max 40W

3

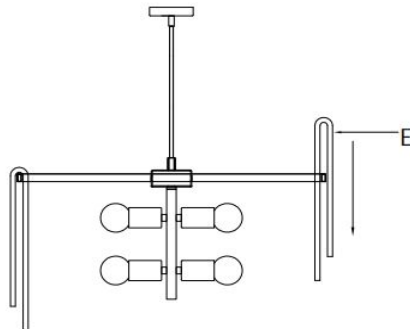

Install the glass sticks (E) on the lamp body according to the illustration

