

"IMPORTANT, RETAIN FOR FUTURE REFERENCE: READ CAREFULLY"

German: WICHTIG, FÜR SPÄTERE NACHSCHLAGE AUFBEWAHREN: SORGFÄLTIG LESEN

Spanish: IMPORTANTE, GUARDAR PARA REFERENCIA FUTURA: LEER ATENTAMENTE

Italian: IMPORTANTE, CONSERVARE PER RIFERIMENTI FUTURI: LEGGERE ATTENTAMENTE

French: IMPORTANT, À CONSERVER POUR RÉFÉRENCE FUTURE : LIRE ATTENTIVEMENT



1. Two or more people are required for assembly.

2. To avoid squeaking, please tighten the bolts all the way.

An electric drill is recommended for the assembly.

3. Professional installation is highly recommended.

1. Für den Zusammenbau werden zwei oder mehr Personen benötigt.

2. Um Quietschgeräusche zu vermeiden, ziehen Sie die Schrauben bitte ganz fest.

Die Verwendung einer elektrischen Bohrmaschine wird empfohlen.

3. Ein fachgerechter Einbau wird dringend empfohlen.

1. Il faut au moins deux personnes pour le montage.

2. Pour éviter tout grincement, veuillez serrer les boulons à fond. Il est recommandé d'utiliser une perceuse électrique.

3. Une installation professionnelle est fortement recommandée.

1. E' necessario due o più persone per l'installazione.



2. Per evitare cigolii, serrare bene i bulloni. Si consiglia di utilizzare un trapano elettrico.

3. Si consiglia vivamente un'installazione professionale.



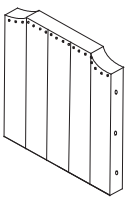

1. Se necesitan dos o más personas para el montaje.

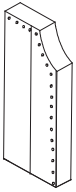
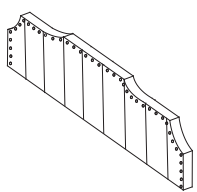
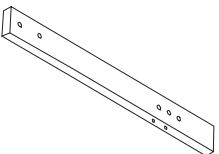
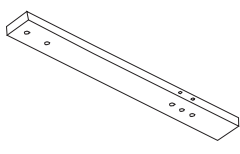
2. Para evitar chirridos, apriete todos los tornillos. Se recomienda utilizar un taladro eléctrico.

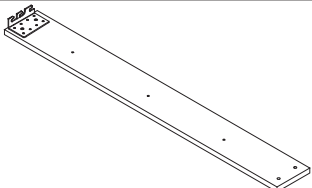
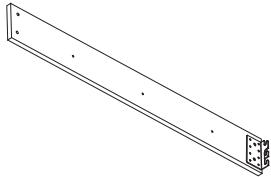
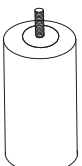
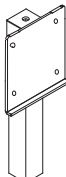
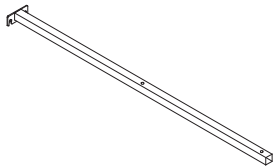
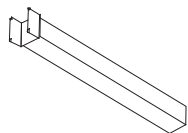
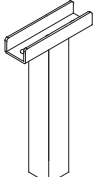
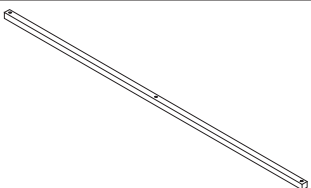
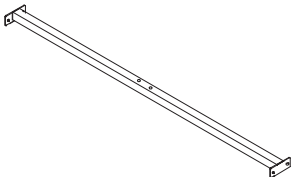
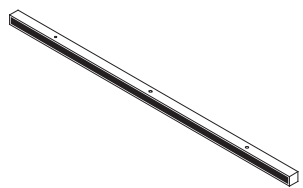
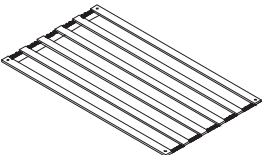
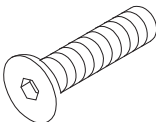
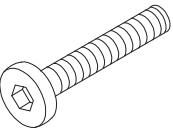
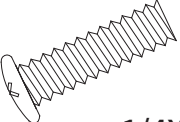
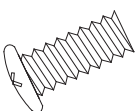
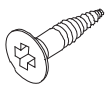
3. Se recomienda encarecidamente la instalación profesional.

| Item no.<br>Nr.<br>N° d'article<br>Articolo No.<br>Artículo No. | Reference Image<br>Referenzbild<br>Image de référence<br>Immagine di riferimento<br>Imagen de referencia | Qty.<br>Menge<br>Qté.<br>Qtà<br>Cant. | Item no.<br>Nr.<br>N° d'article<br>Articolo No.<br>Artículo No. | Reference Image<br>Referenzbild<br>Image de référence<br>Immagine di riferimento<br>Imagen de referencia | Qty.<br>Menge<br>Qté.<br>Qtà<br>Cant. |
|---|--|---------------------------------------|---|--|---------------------------------------|
| 1A  |                       | X1                                    | 1B  |                     | X1                                    |
| 1C  |                       | X1                                    | 2   |                     | X1                                    |
| 3   |                       | X1                                    | 4   |                     | X1                                    |

| Item no.<br>Nr.<br>N° d'article<br>Articolo No.<br>Artículo No. | Reference Image<br>Referenzbild<br>Image de référence<br>Immagine di riferimento<br>Imagen de referencia | Qty.<br>Menge<br>Qté.<br>Qtà<br>Cant. | Item no.<br>Nr.<br>N° d'article<br>Articolo No.<br>Artículo No. | Reference Image<br>Referenzbild<br>Image de référence<br>Immagine di riferimento<br>Imagen de referencia | Qty.<br>Menge<br>Qté.<br>Qtà<br>Cant. |
|---|--|---------------------------------------|---|--|---------------------------------------|
| 5   |                         | X2                                    | 6   |                       | X2                                    |
| 7   |                         | X2                                    | 8   |                       | X2                                    |
| 9   |                        | X2                                    | 10  |                      | X2                                    |
| 11  |                       | X1                                    | 12  |                     | X1                                    |
| 13  |                       | X1                                    | 14  |                     | X4                                    |
| 15  |                       | X2                                    | A   | <br>5/16X35mm       | X22<br>+<br>2extra                    |
| B   | <br>5/16X55mm         | X15<br>+<br>1extra                    | C   | <br>1/4X35mm        | X12<br>+<br>1extra                    |
| D   | <br>1/4X15mm          | X8<br>+<br>1extra                     | E   | <br>M4X25mm         | X8<br>+<br>1extra                     |

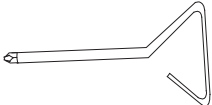
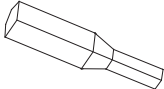
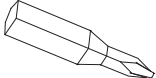
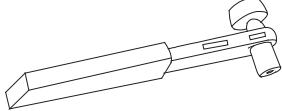
| Item no.<br>Nr.<br>N° d'article<br>Articolo No.<br>Artículo No. | Reference Image<br>Referenzbild<br>Image de référence<br>Immagine di riferimento<br>Imagen de referencia   | Qty.<br>Menge<br>Qté.<br>Qtà<br>Cant. | Item no.<br>Nr.<br>N° d'article<br>Articolo No.<br>Artículo No. | Reference Image<br>Referenzbild<br>Image de référence<br>Immagine di riferimento<br>Imagen de referencia    | Qty.<br>Menge<br>Qté.<br>Qtà<br>Cant. |
|---|--|---------------------------------------|---|---|---------------------------------------|
| <b>F</b>  | <br>$\phi 19 \times 5/16$ | X37<br>+<br>3extra                    | <b>G</b>  | <br>$\phi 16 \times 1/4$ | X20<br>+<br>3extra                    |
| <b>H</b>  | <br>$\phi 12 \times 5/16$ | X37<br>+<br>3extra                    | <b>I</b>  | <br>M8                   | X1                                    |
| <b>J</b>  |                          | X1                                    | <b>K</b>  | <br>5/16                | X1                                    |
| <b>L</b>  | <br>1/4                 | X1                                    | <b>M</b>  |                        | X1                                    |

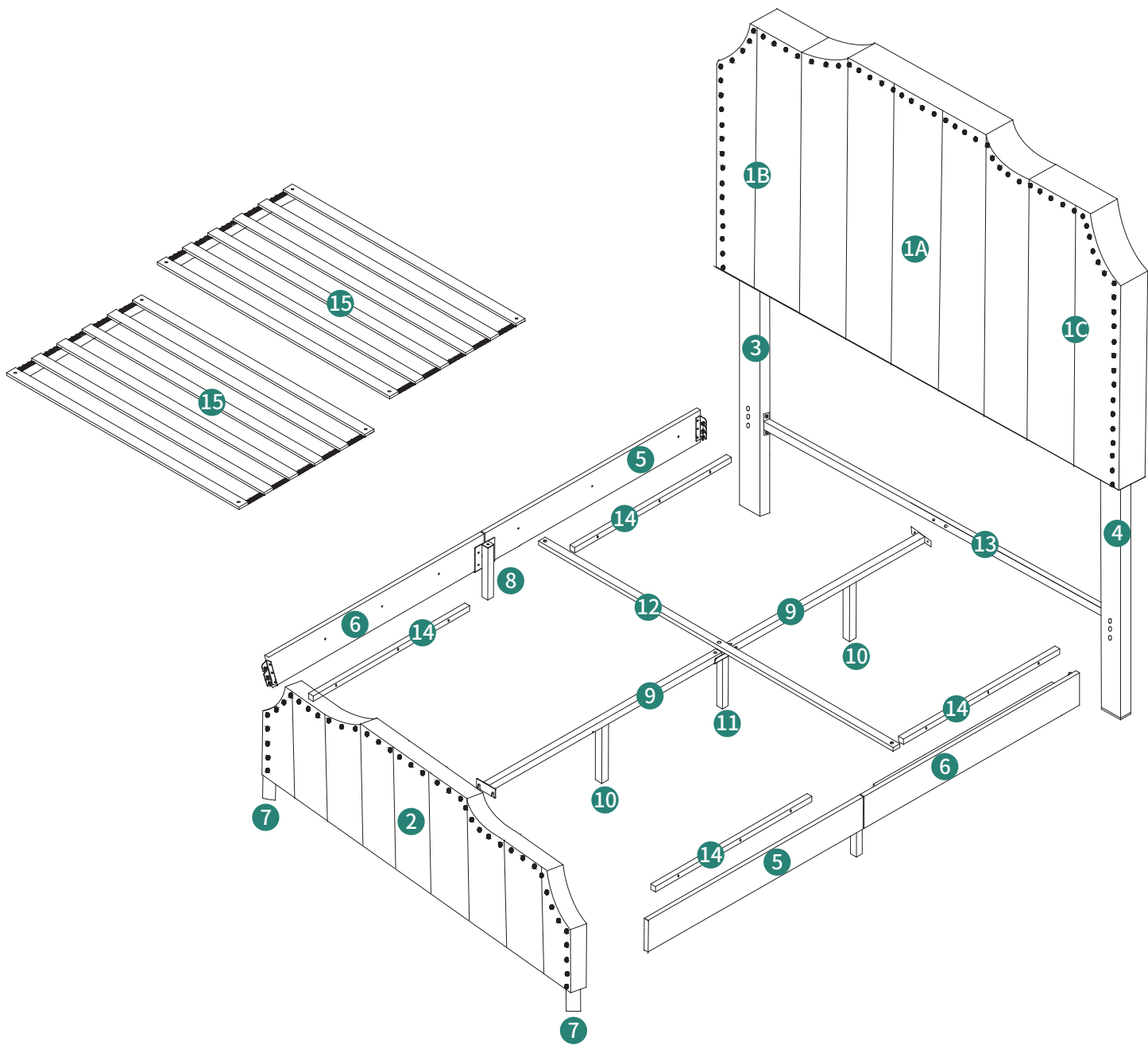

1

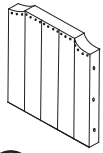

1A 1pc



1B 1pc

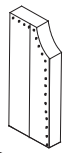

1C 1pc



B 6pcs



F 6pcs



H 6pcs

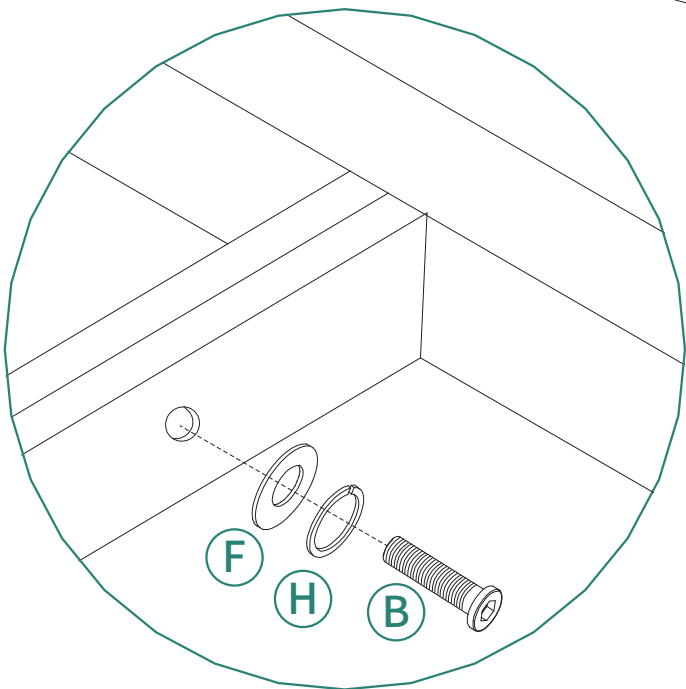
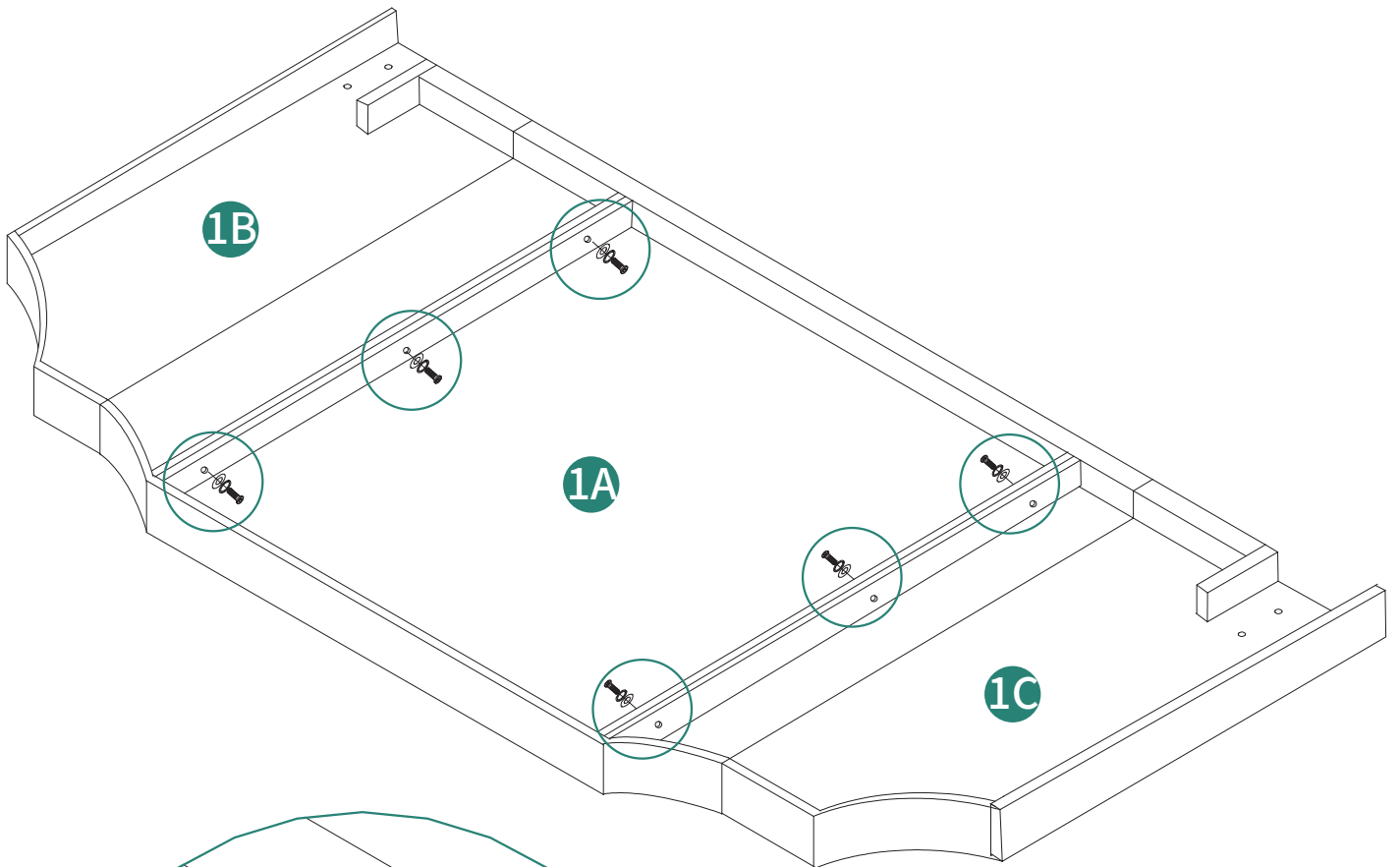

# 2



③ 1pc



④ 1pc



5/16X55mm

Ⓑ 4pcs



φ19X5/16

Ⓕ 4pcs



φ12X5/16

Ⓖ 4pcs

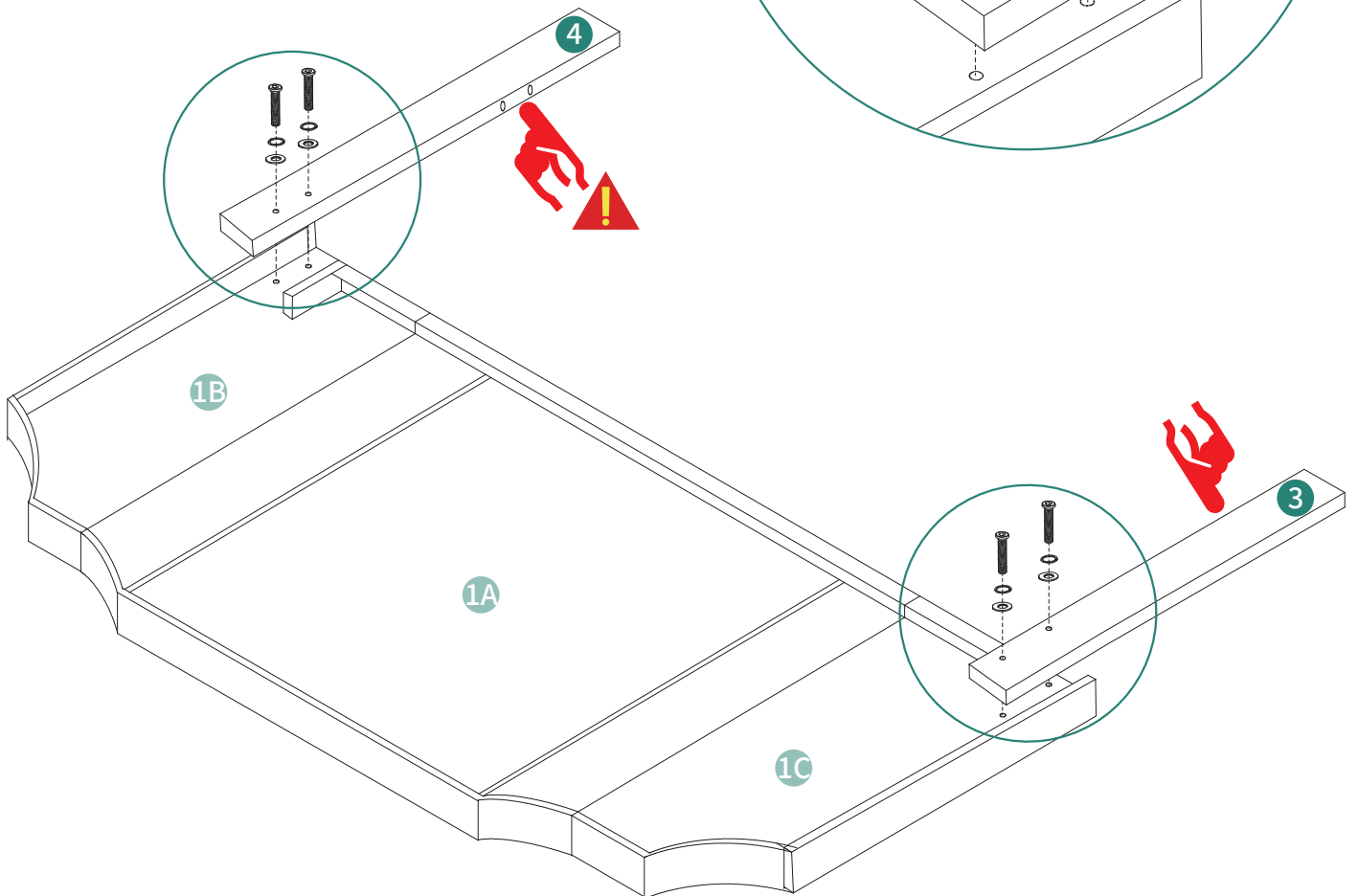
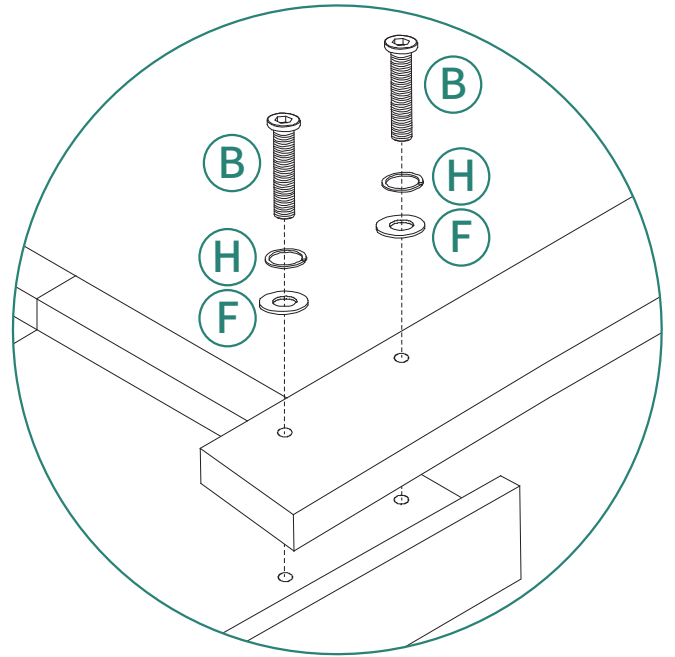

3

5/16X35mm     $\phi 19 \times 5/16$      $\phi 12 \times 5/16$

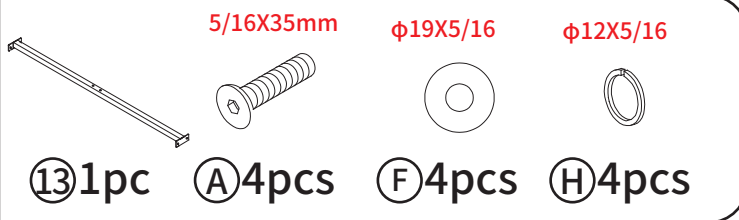

⑬ 1pc    ① 4pcs    ② 4pcs    ③ 4pcs

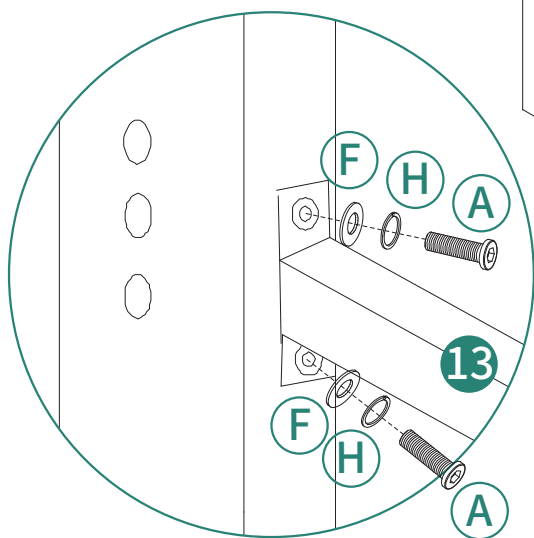
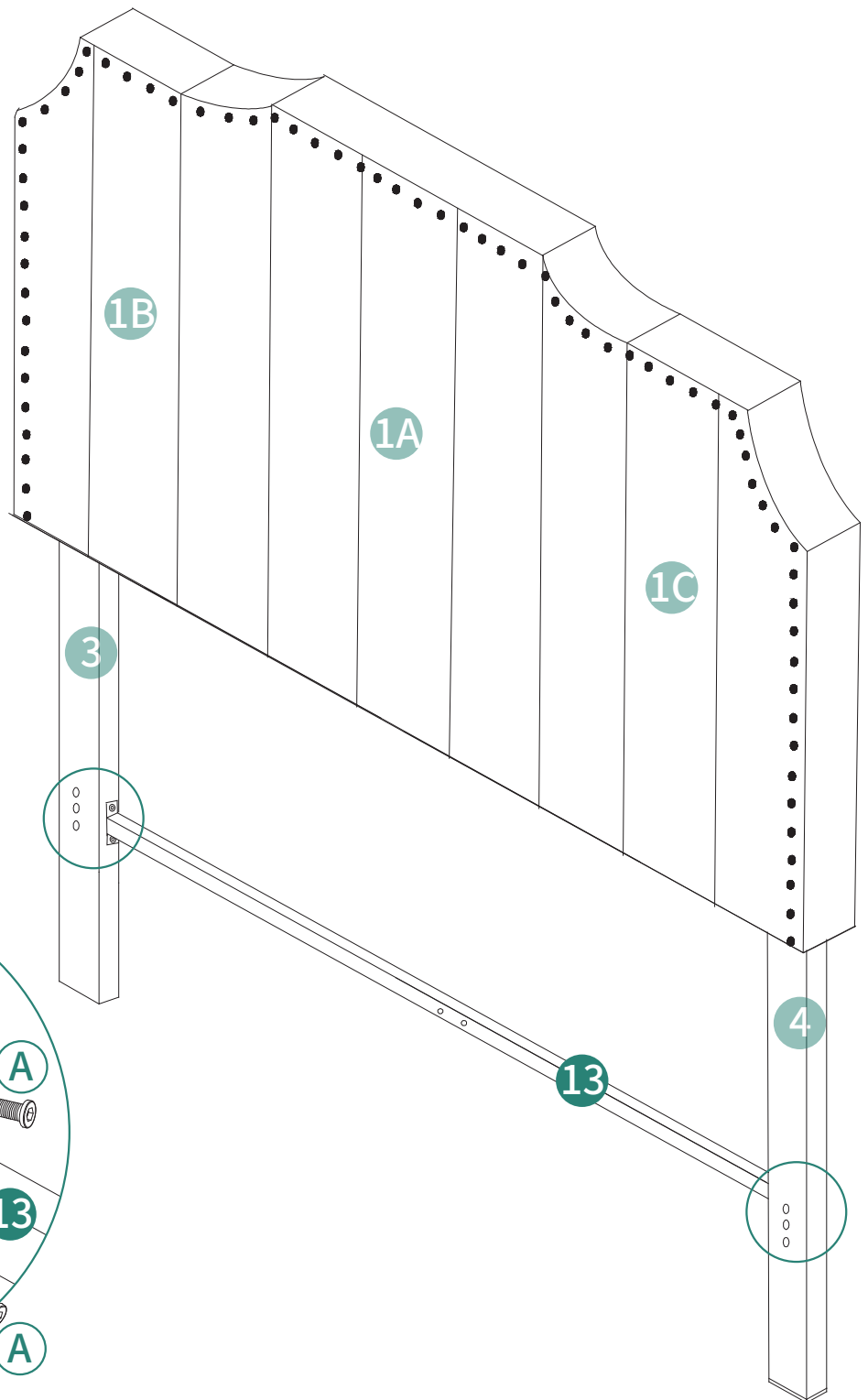

4

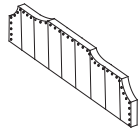

② 1pc

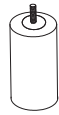

⑦ 2pcs

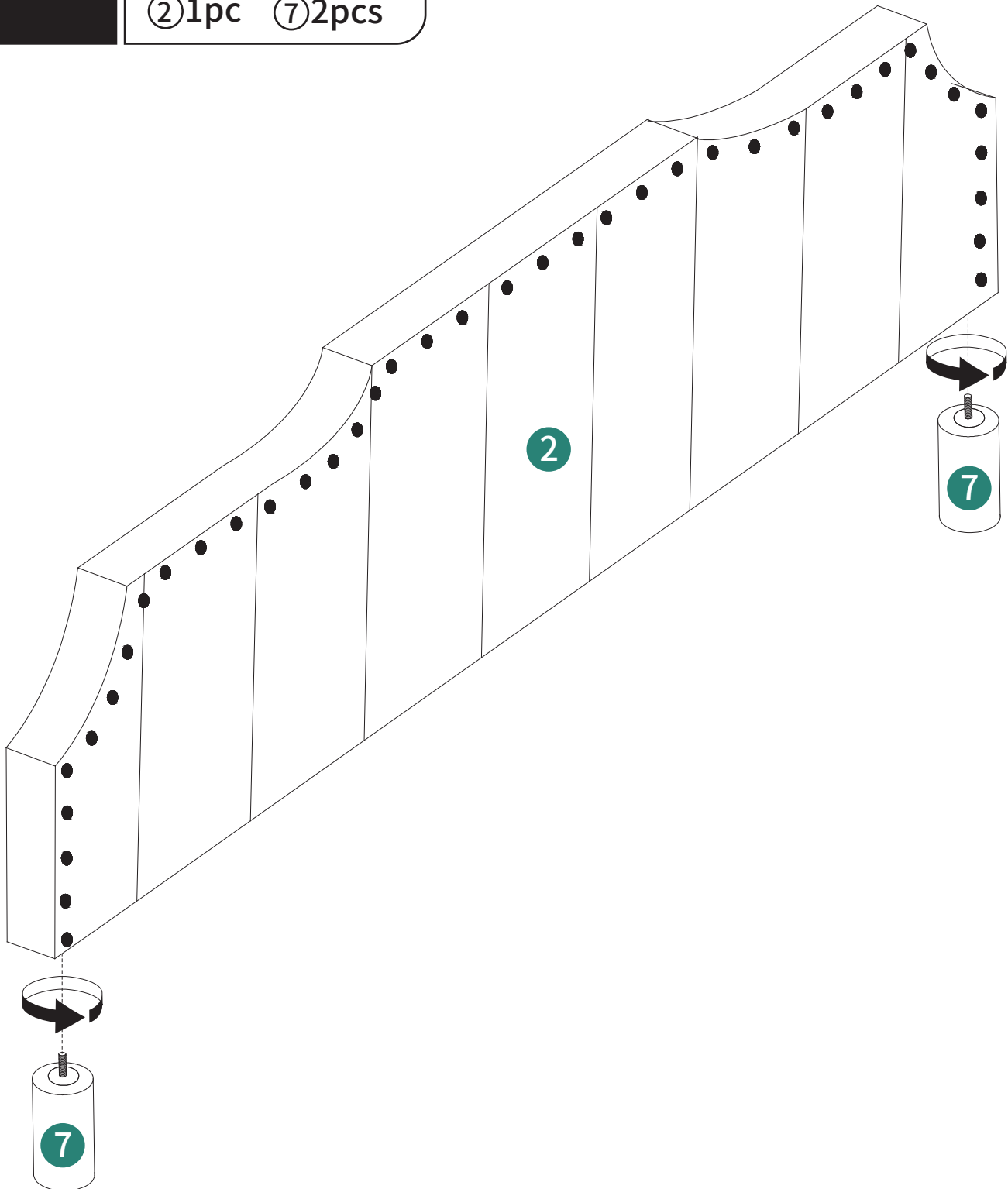

5

X2

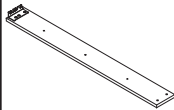

⑤ 2pcs

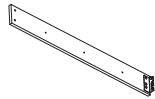

⑥ 2pcs

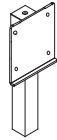

⑧ 2pcs

1/4X15mm



① D 8pcs

φ16X1/4



② G 8pcs

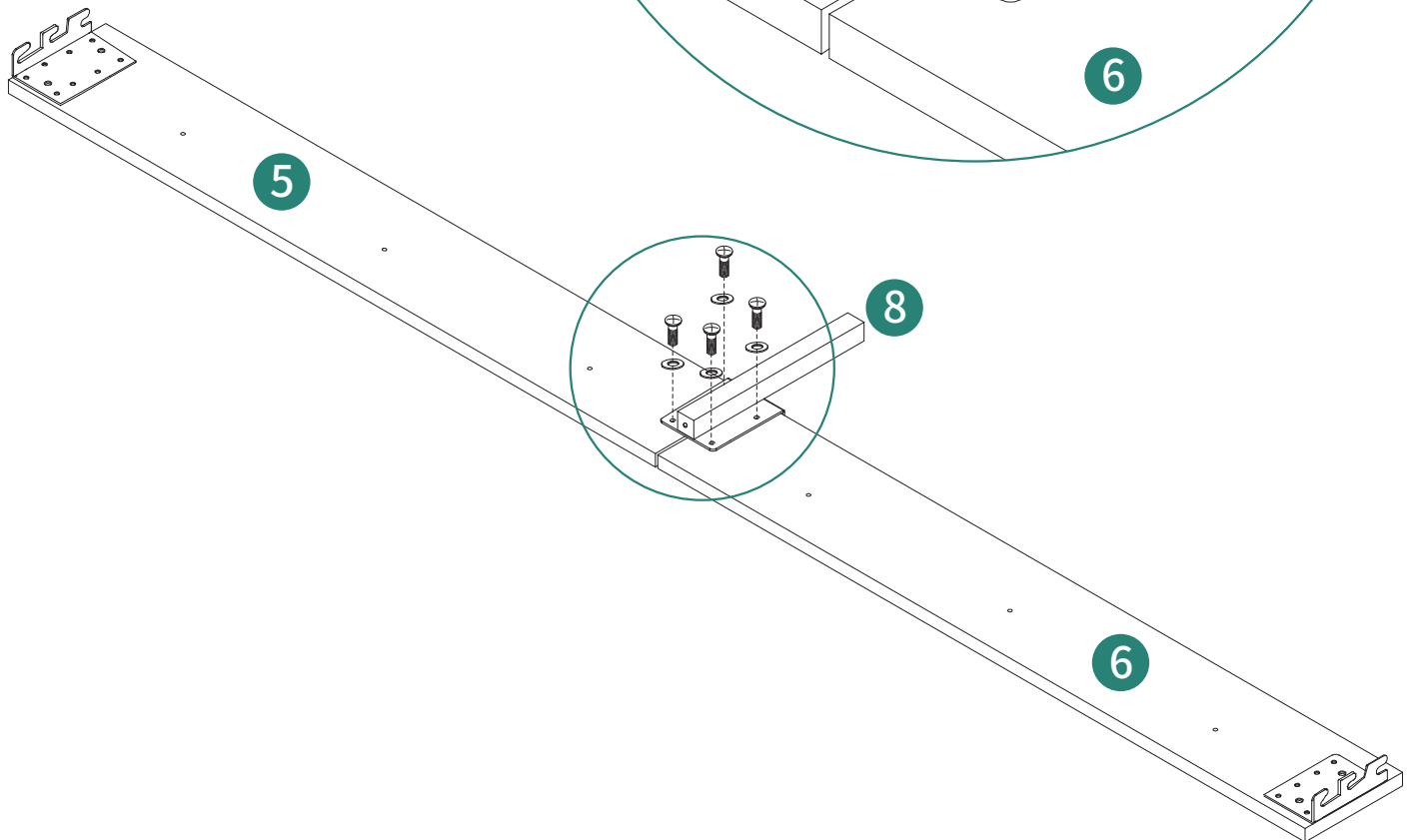
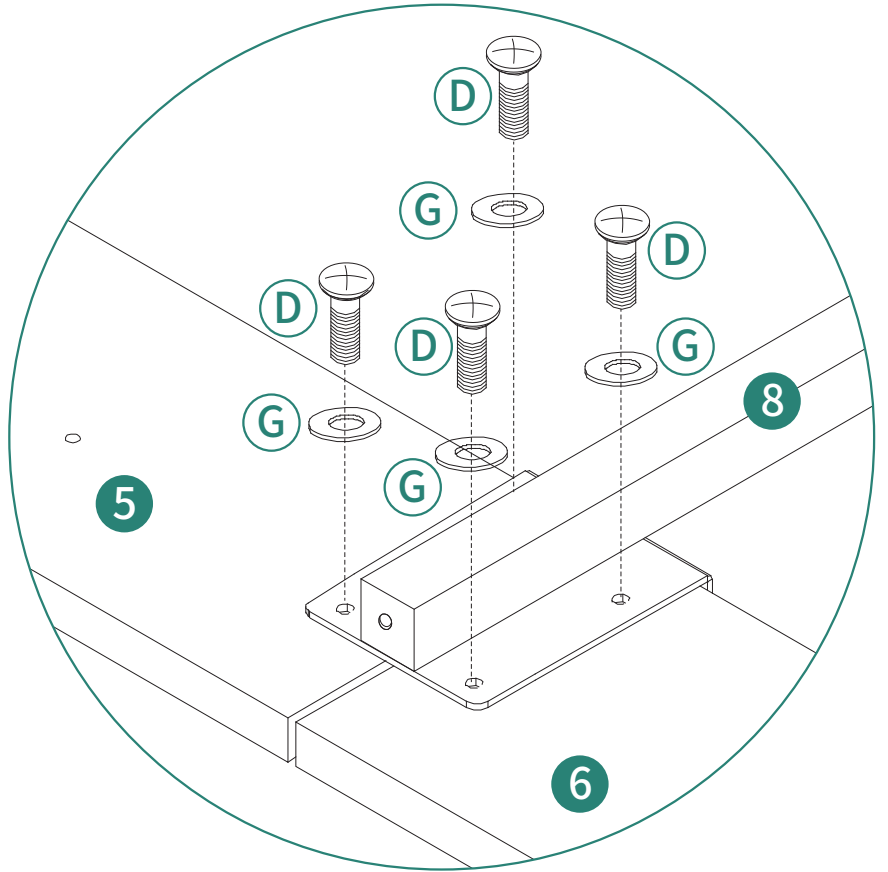

6

X2



1/4X35mm

φ16X1/4

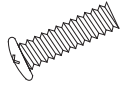

⑭4pcs

Ⓒ12pcs

Ⓔ12pcs

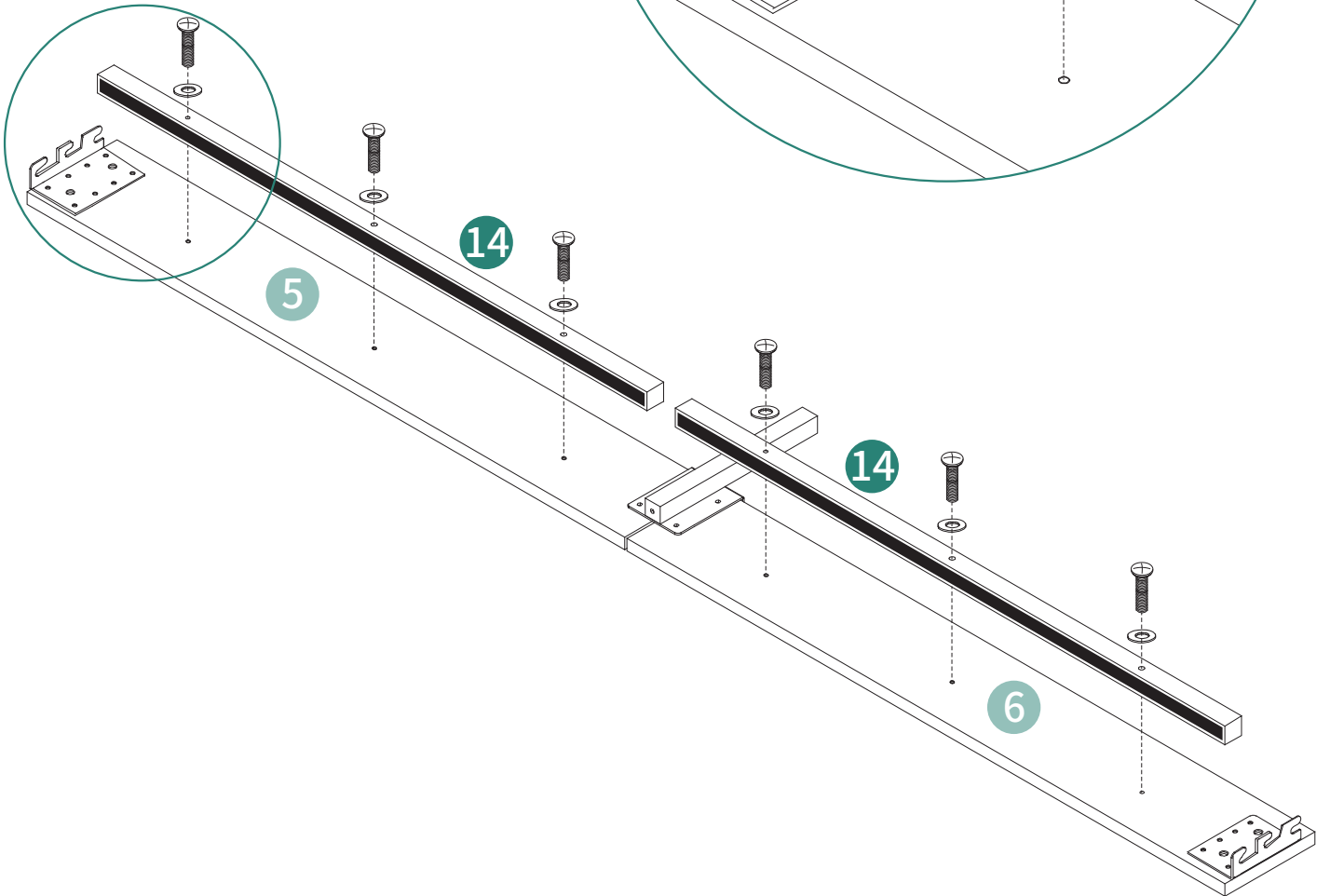
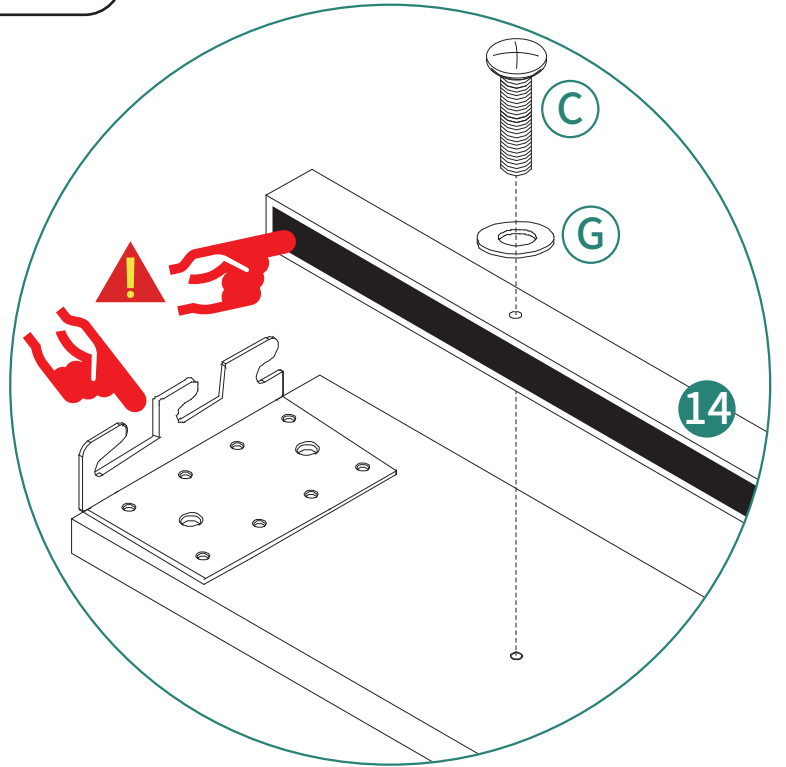

# 7

5/16X35mm

φ19X5/16

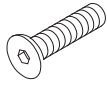

φ12X5/16

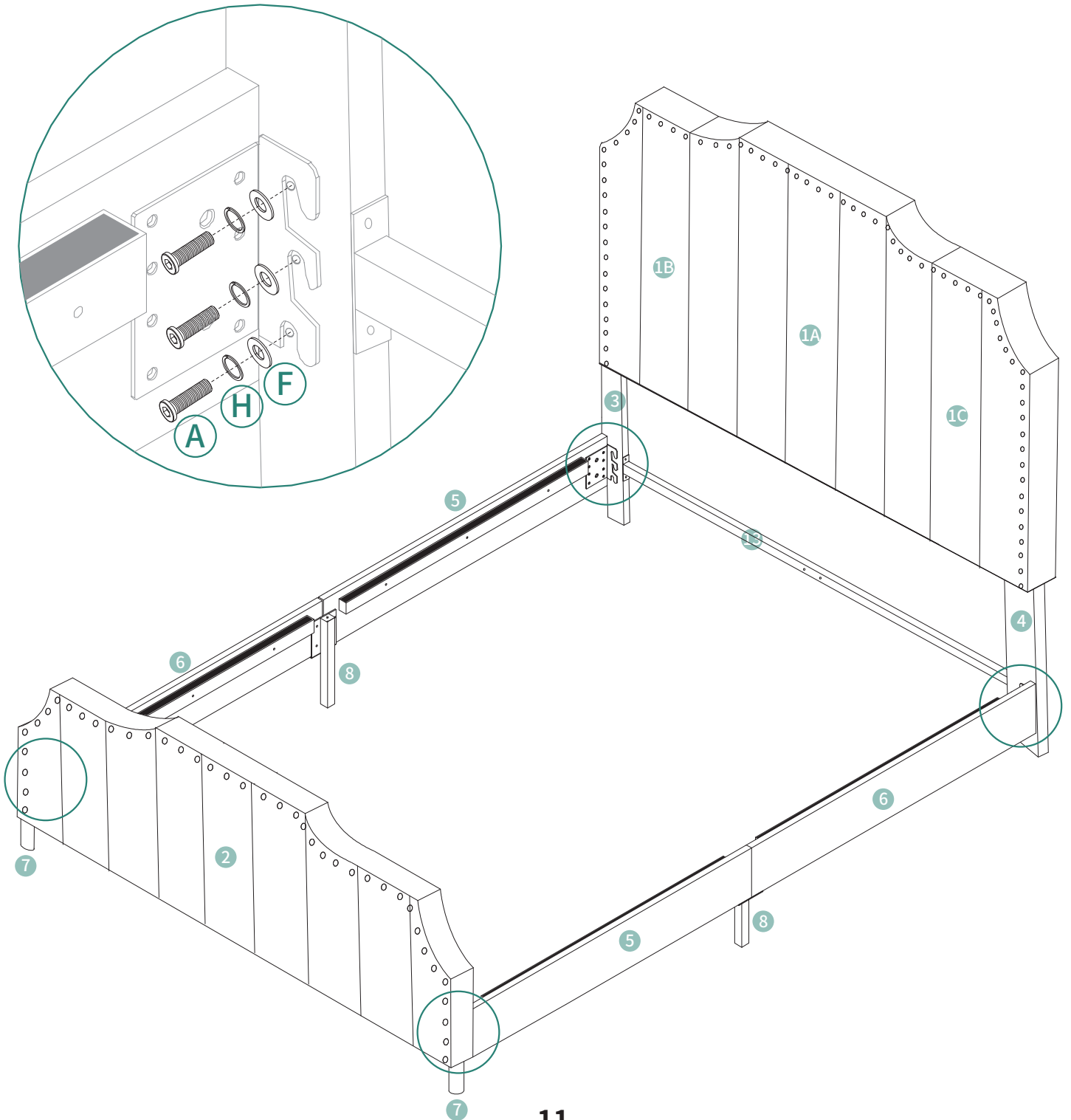
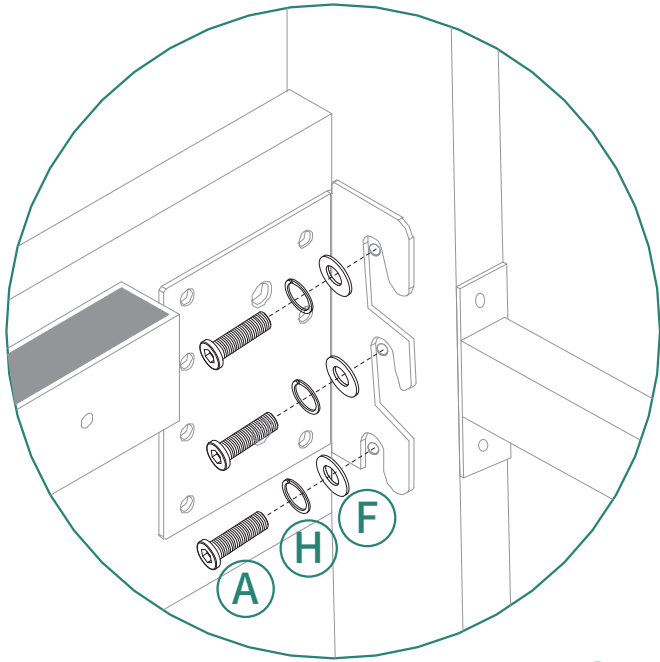

(A)12pcs (F)12pcs (H)12pcs

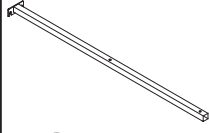
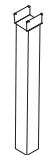
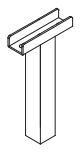
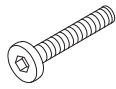

# 8

-  ⑨ 2pcs
-  ⑩ 2pcs
-  ⑪ 1pc
-  5/16X55mm B 4pcs
-  φ19X5/16 F 4pcs
-  φ12X5/16 H 4pcs

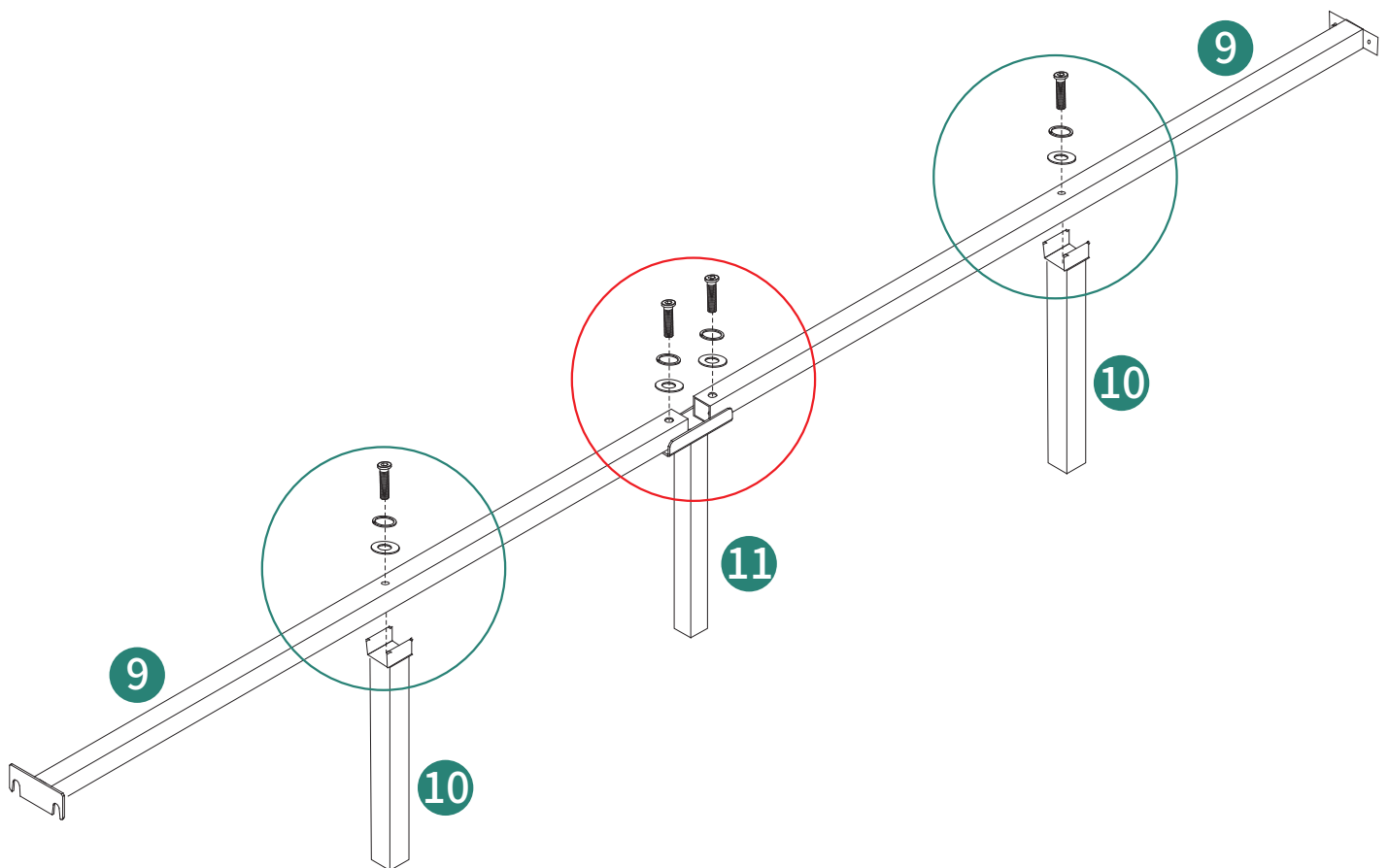
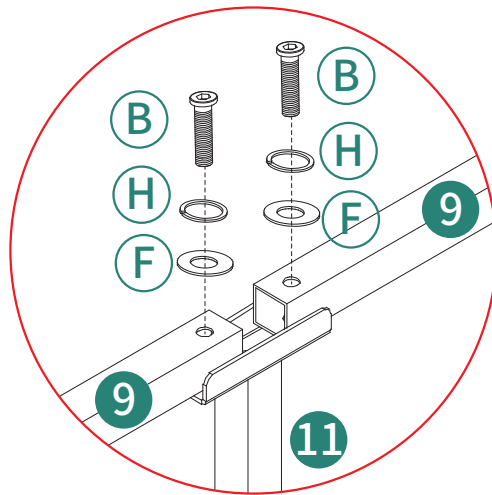
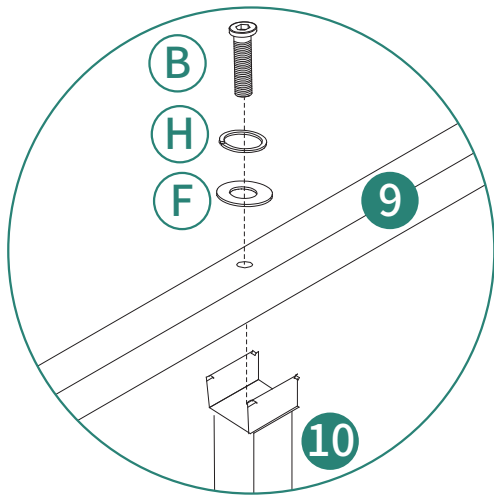

# 9

5/16X35mm

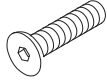

(A) 4pcs

φ19X5/16



(F) 4pcs



φ12X5/16

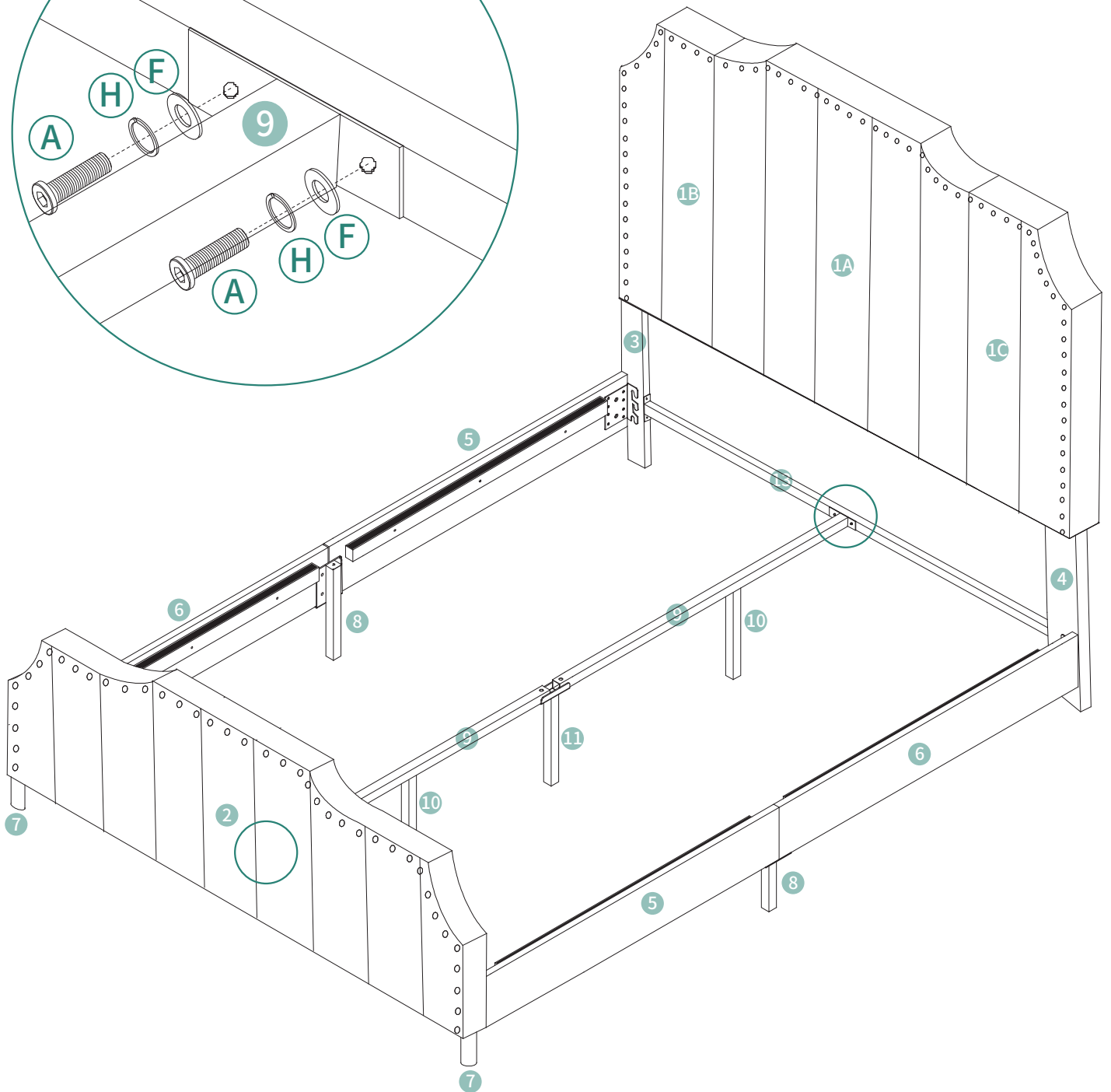
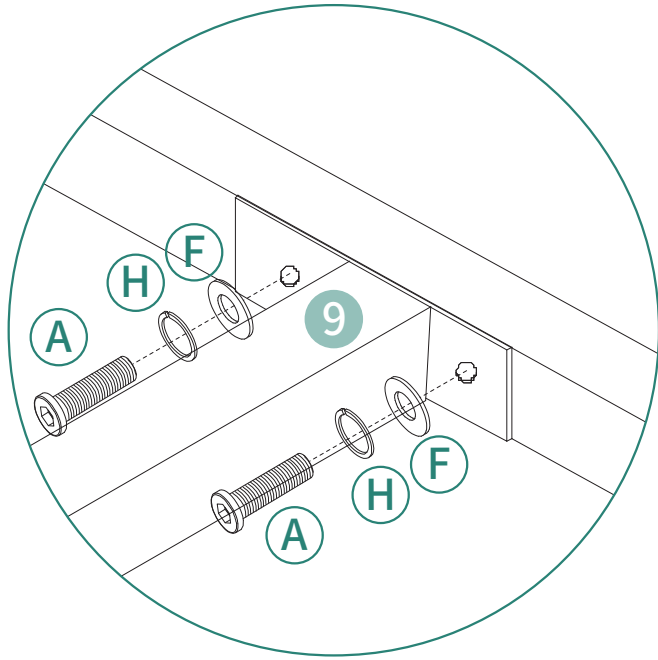

(H) 4pcs

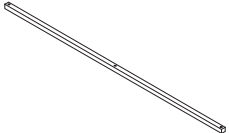
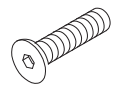
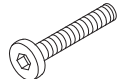

# 10

|   |   |   |   |   |
|---|---|---|---|---|
|  |  |  |  |  |
| ⑫ 1pc   | Ⓐ 2pcs  | Ⓑ 1pc   | Ⓕ 3pcs  | Ⓖ 3pcs  |

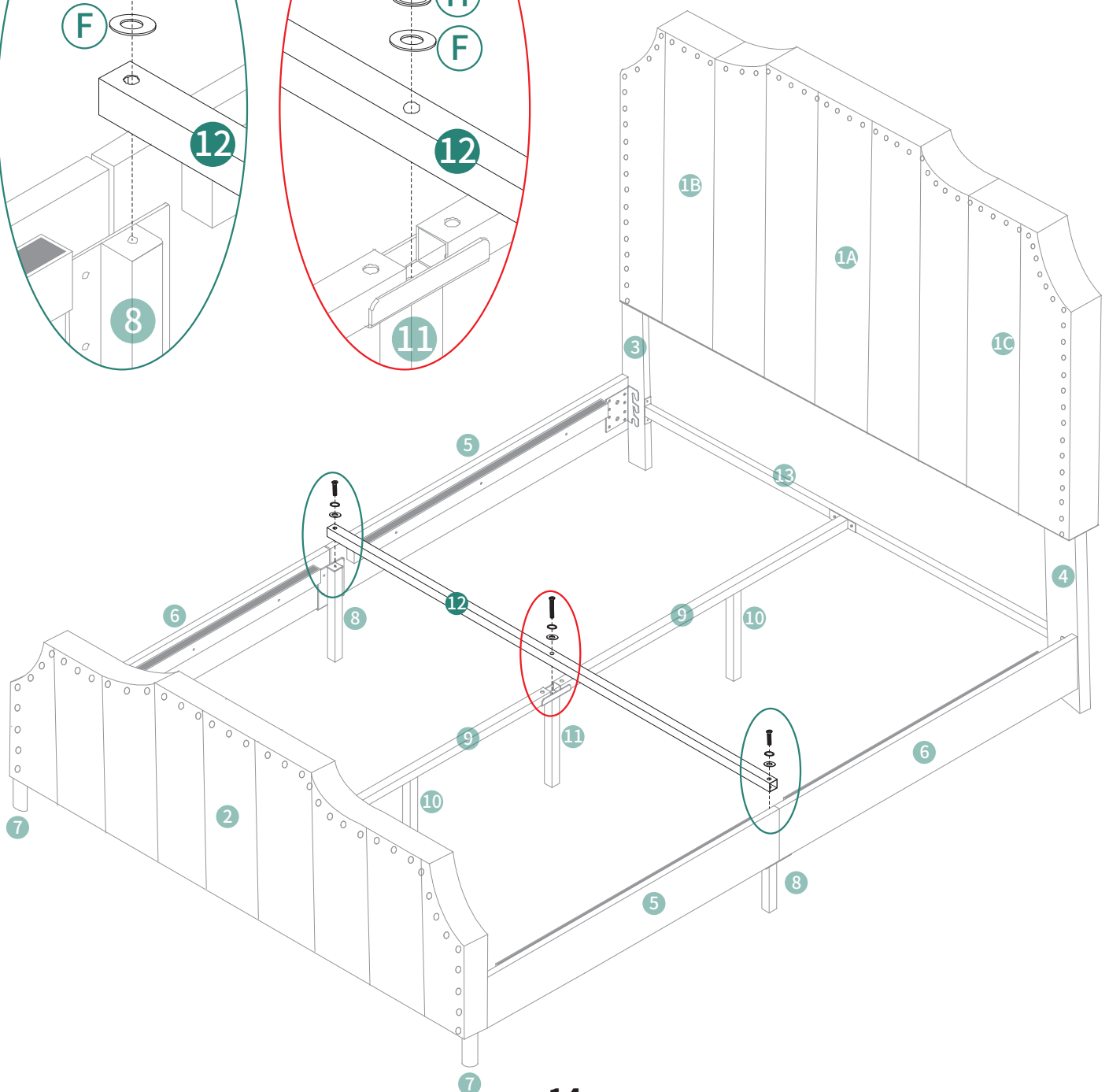
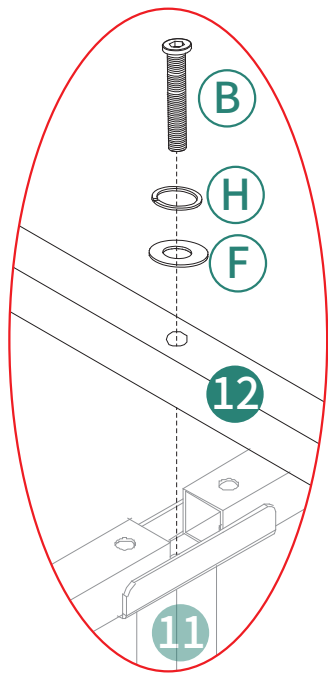
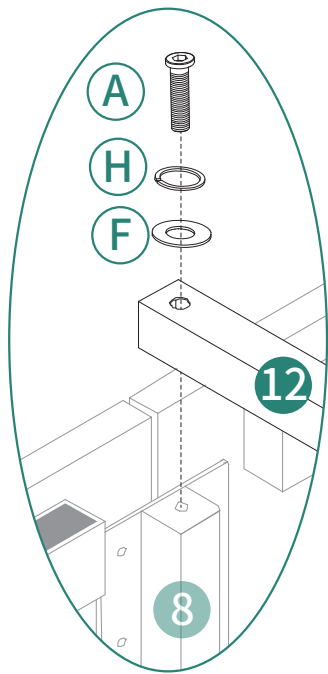

# 11

M4X25mm

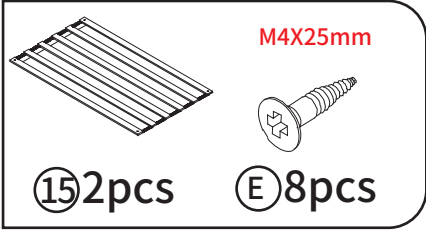

⑮ 2pcs    ⑮ 8pcs

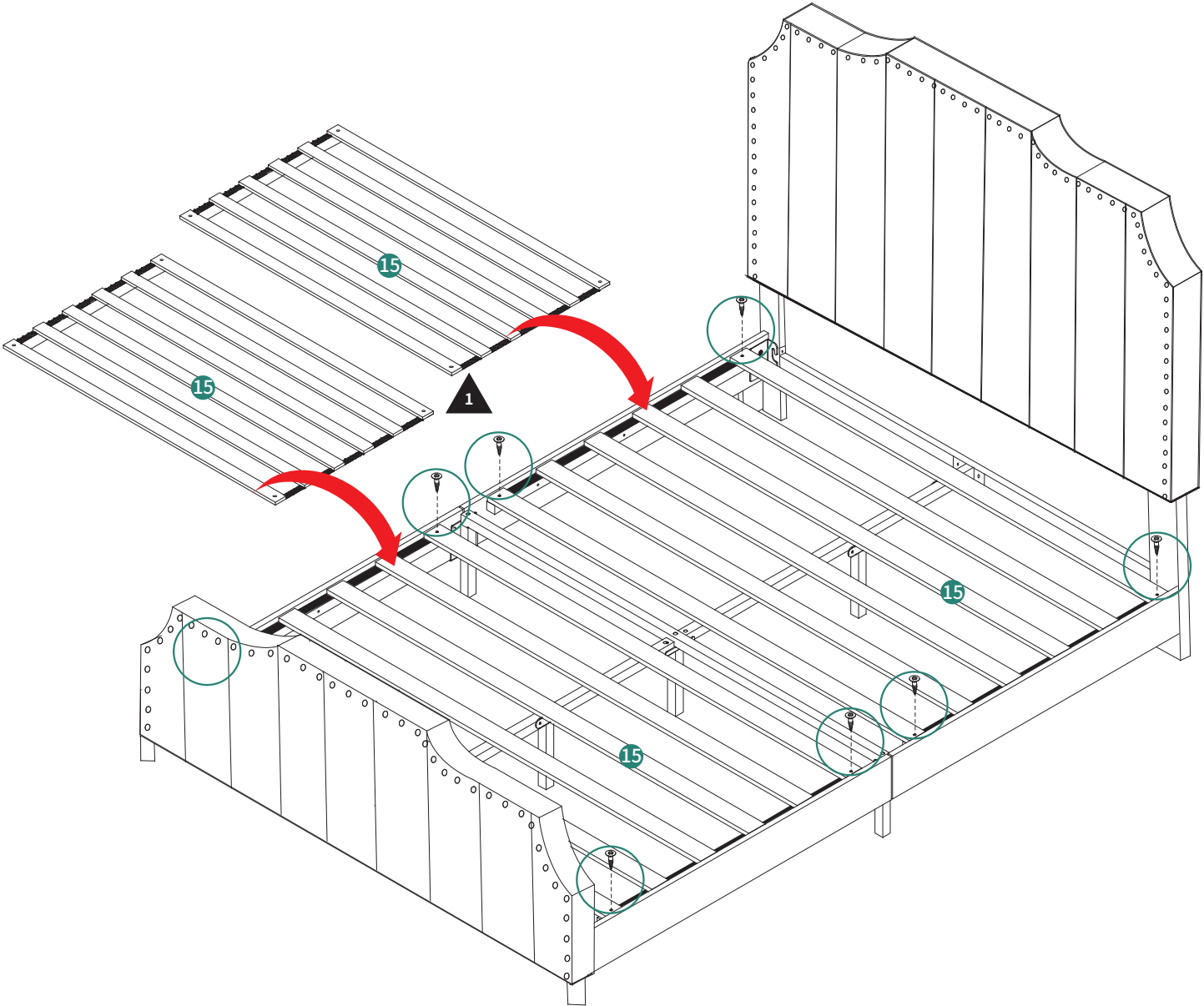
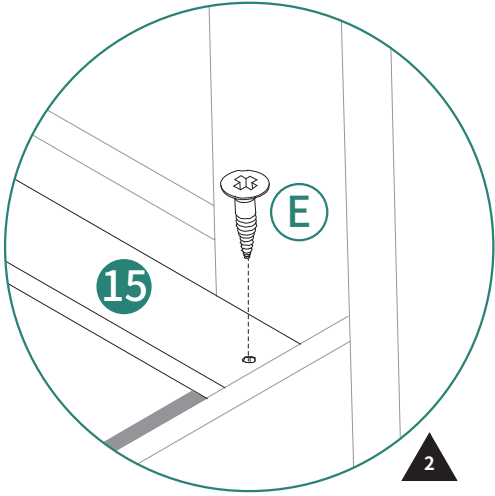

12



Installation Completed

Installation abgeschlossen

Installation complétée

Installazione completata

Instalación completada