

ASSEMBLY INSTRUCTIONS
INSTRUCTIONS DE MONTAGE

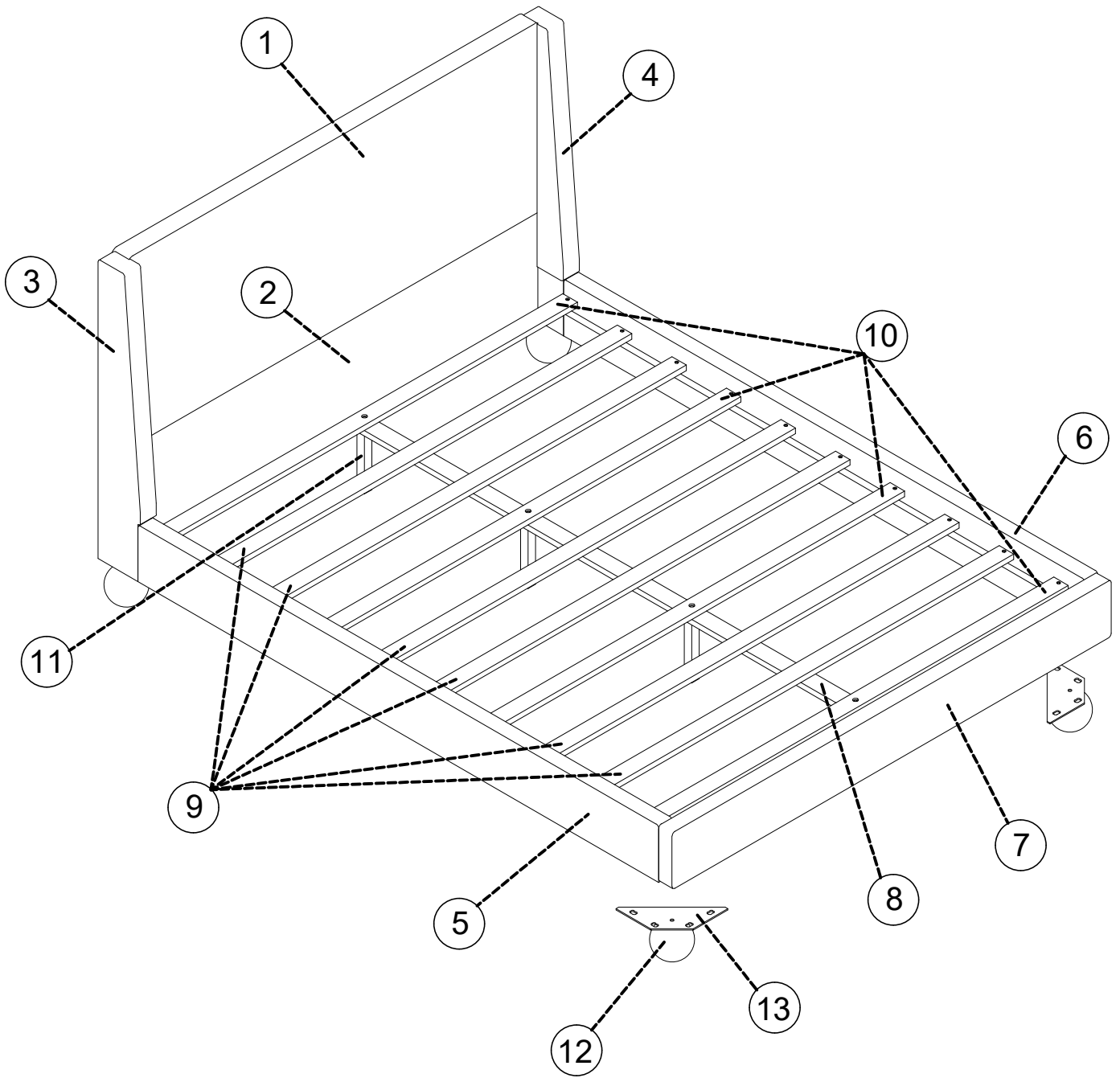

PARTS

LES PIÈCES

Check that you've received
all parts listed below.

BOX: 1/2
BOITE: 1/2

vérifiez que vous avez reçu toutes les
pièces répertoriées ci-dessous

① x 1

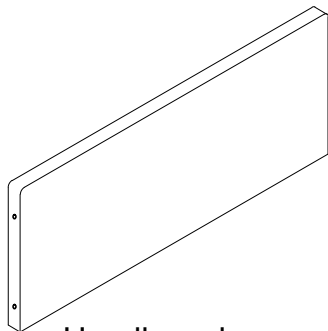

Headboard
Tête de lit

② x 1

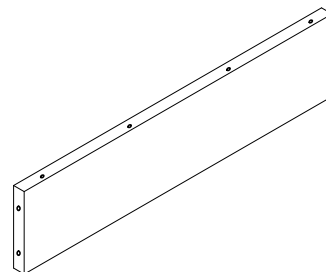

Headboard below
Tête de lit en dessous

③ x 1

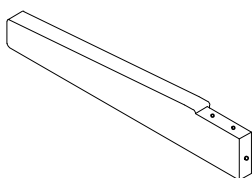

Bedside ear Left
Oreille de chevet gauche

④ x 1

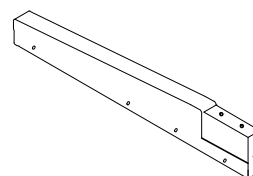

Bedside ear Right
Oreille de chevet droite

⑨ x 6

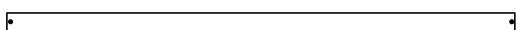

Slats
Lattes

⑩ x 4

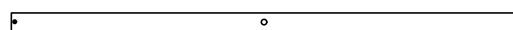

Slats
Lattes

⑪ x 4



Support Legs
Jambes de soutien

⑬ x 2



Metal bas
Base en métal

Hardware
Matériel

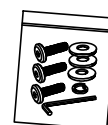

PARTS

LES PIÈCES

Check that you've received
all parts listed below.

BOX: 2/2

BOITE: 2/2

vérifiez que vous avez reçu toutes les
pièces répertoriées ci-dessous

5 x 1

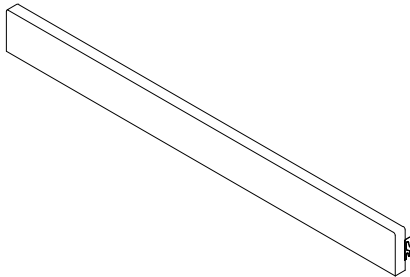

Sideboard Left
Panneau latéral à gauche

6 x 1

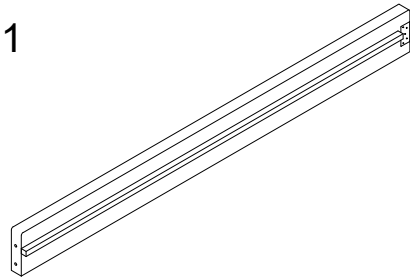

Sideboard Right
Panneau latéral à droit

7 x 1

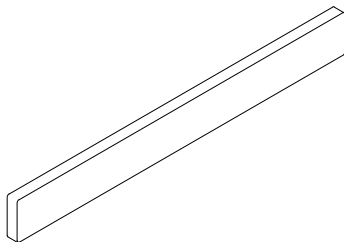

FootBoard
Pied de lit

8 x 1

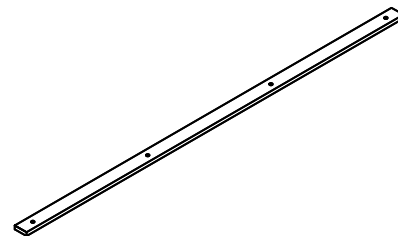

Bed support slat
Latte de support de lit

12 x 4

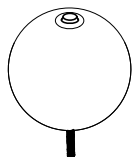









Head&footboard legs
Pieds de tête et pied de lit

KASTEN 1/2
BOÎTE 1/2

HARDWARE LIST

LISTE DU MATÉRIE

No.	OUTLOOK	DESC	QTY
(A)		Bolts (Boulons) 5/16"x30 mm	12
(B)		Plain washer Ø5/16"x19x1.5 mm Rondelle plate	32
(C)		Spring washer Ø5/16"x13 mm Ondelleélastique	32
(D)		Allen key (Clé Allen) 80x30x4 mm	1
(E)		Bolts (Boulons) 5/16"x45 mm	16
(F)		Bolts (Boulons) 5/16"x60 mm	4
(G)		Screws (Des vis) Ø4x30 mm	20
(M)		Nuts (Écrous) Ø5/16"	2
(N)		Wrench (Clé) 12mm*90mmL	1

STEP 1 ÉTAPE 1

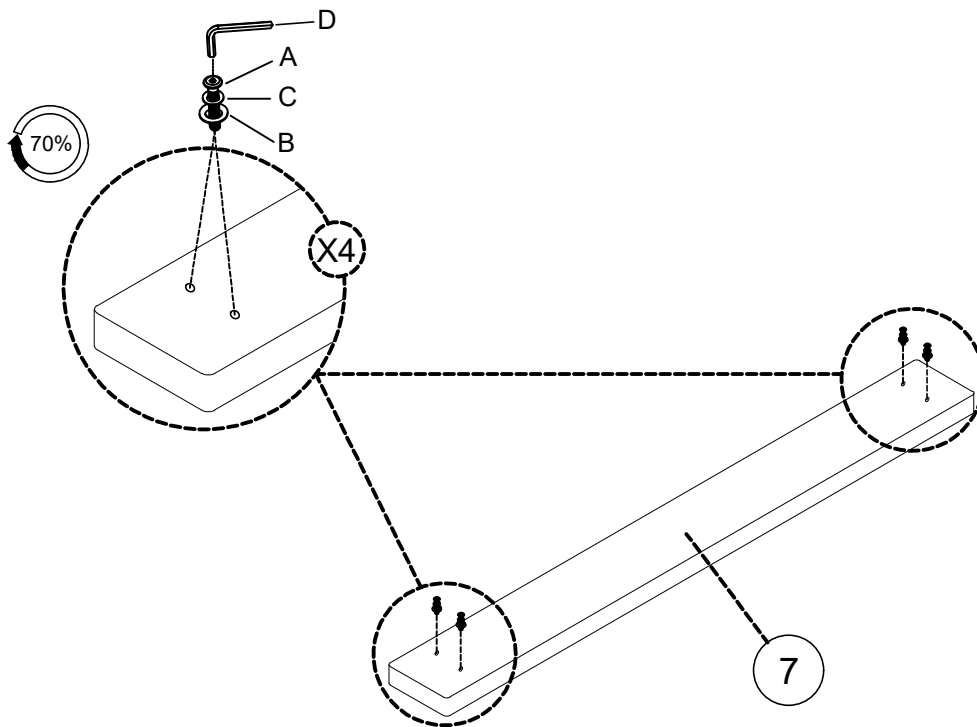
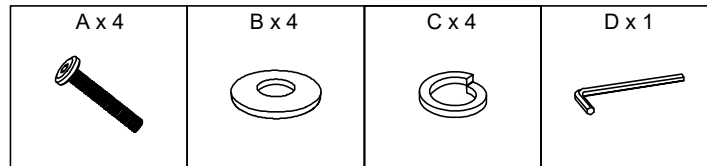

STEP 2 ÉTAPE 2

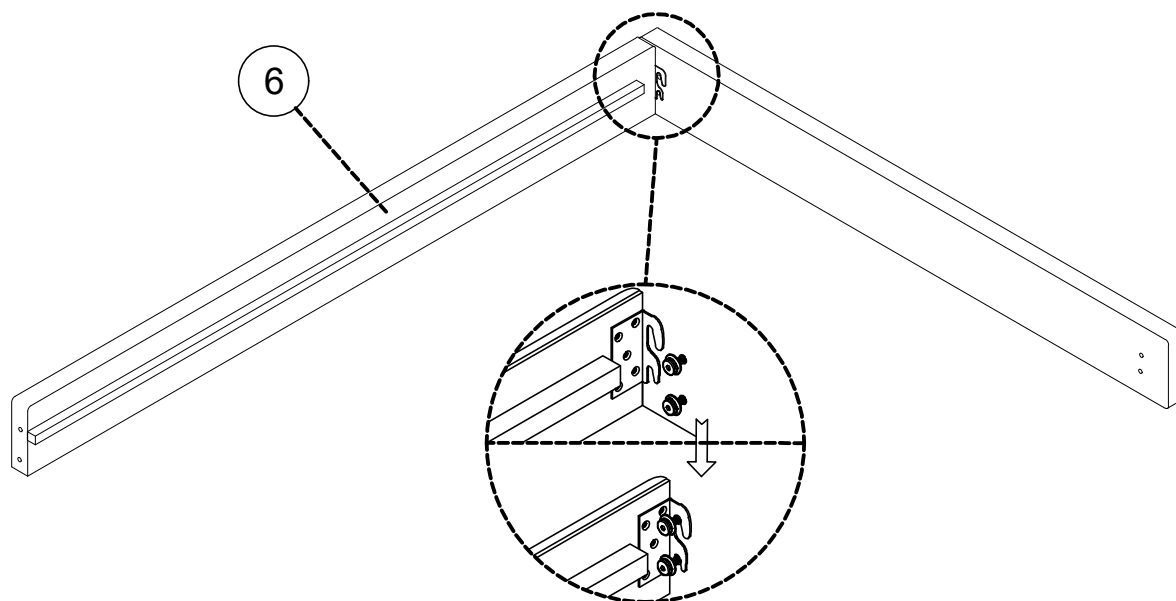

Attach iron bowl to bolts
Fixez le bol en fer au boulons



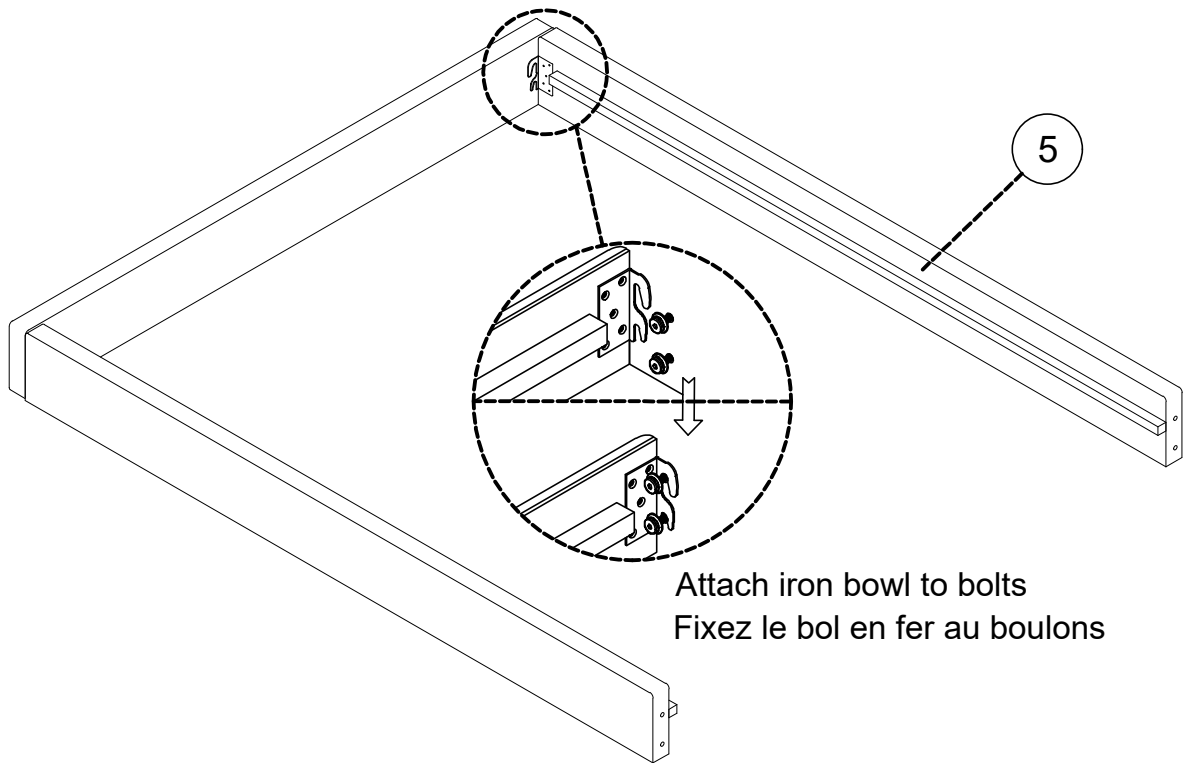

STEP 3 ÉTAPE 3

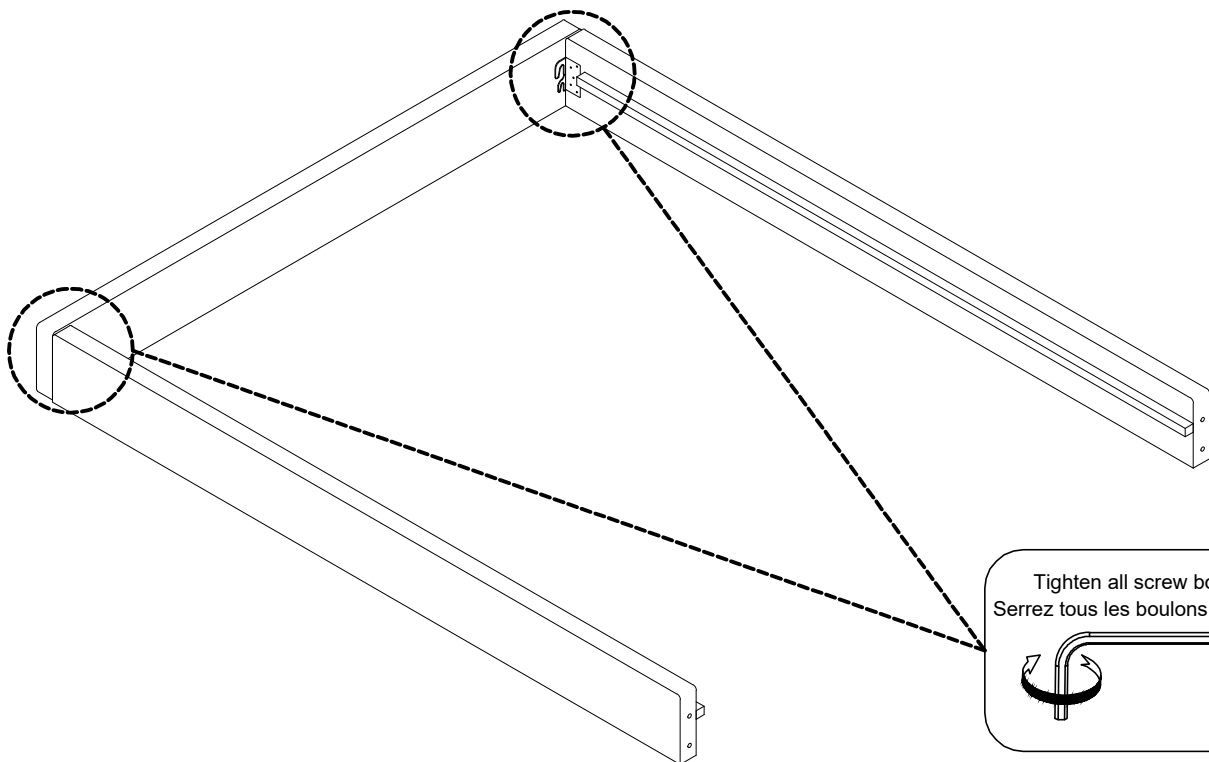
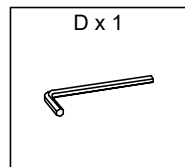

STEP 4 ÉTAPE 4



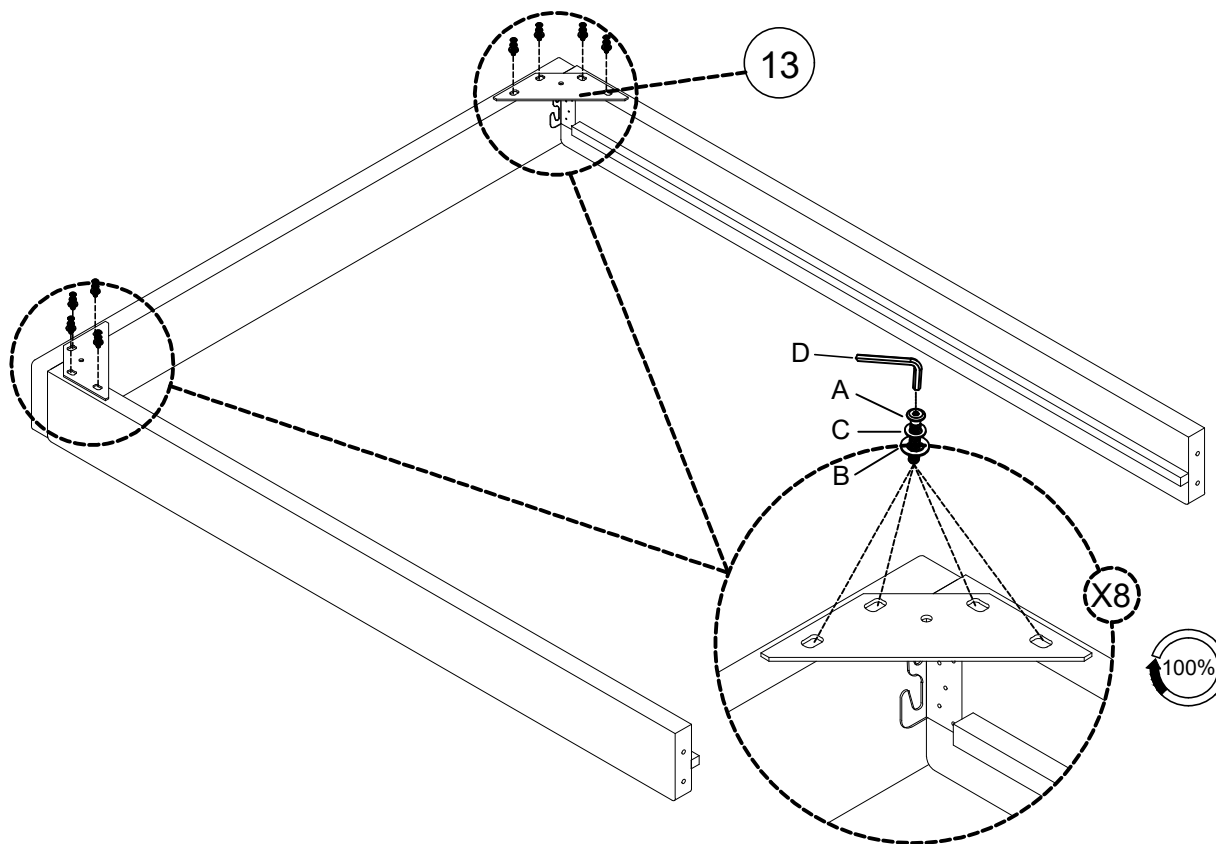

STEP 5 ÉTAPE 5

A x 8 	B x 8 	C x 8 	D x 1 
--	--	--	--



STEP 6 ÉTAPE 6



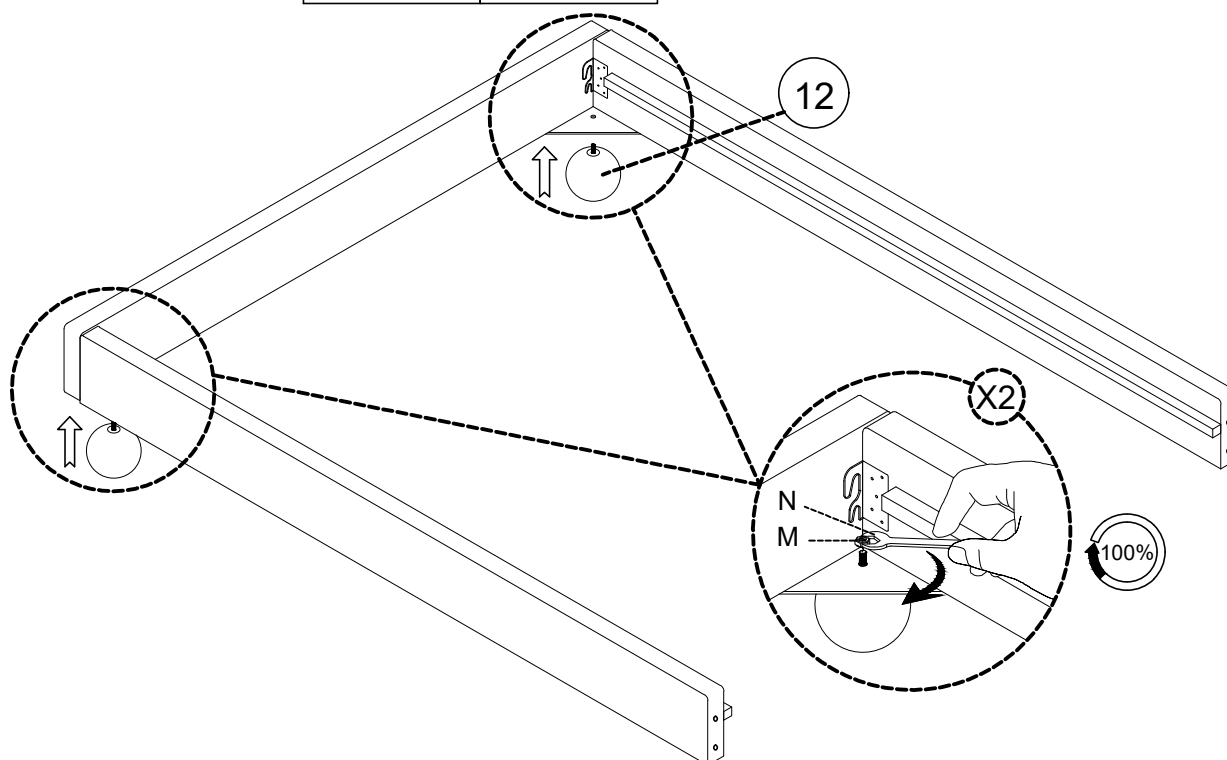

M x 2 	N x 1 
--	--

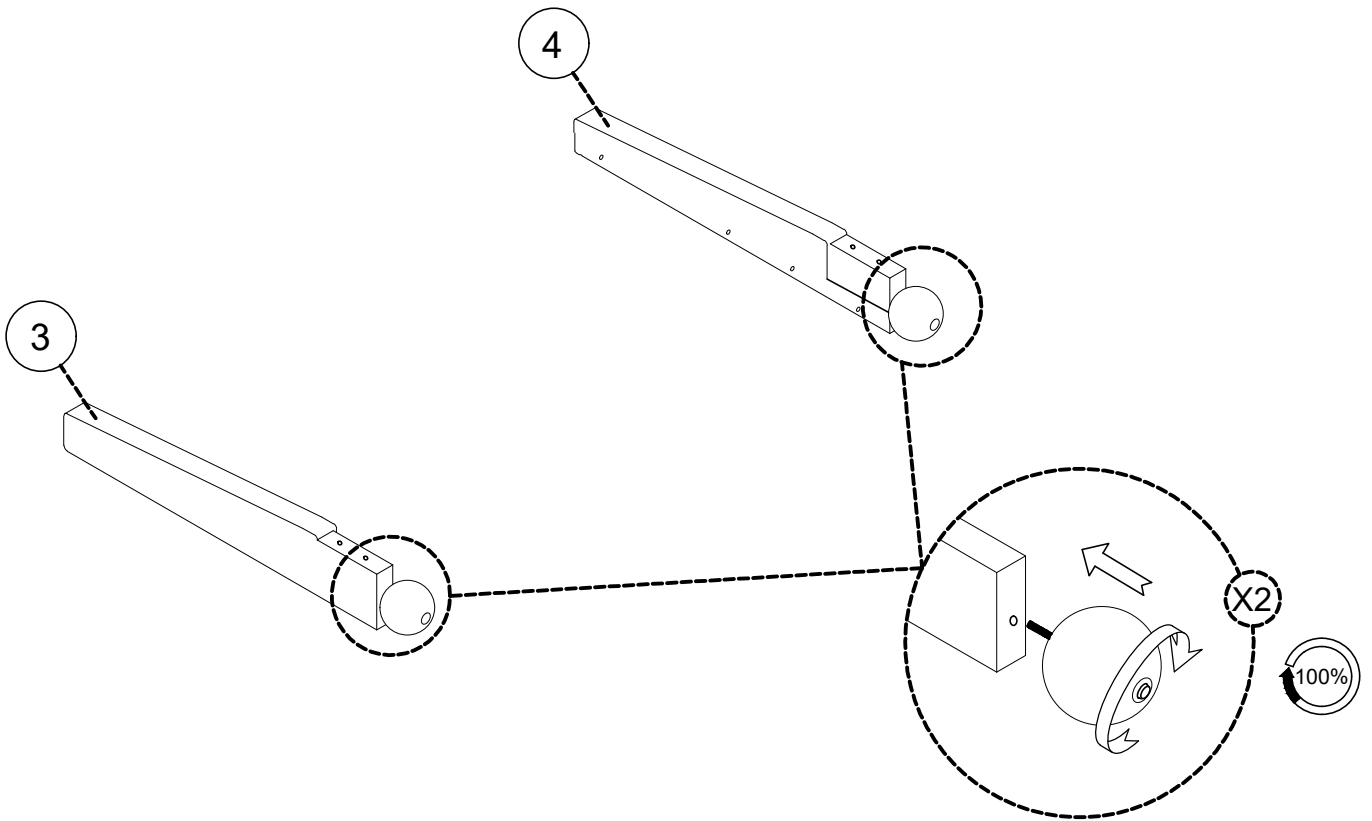

STEP 7 ÉTAPE 7





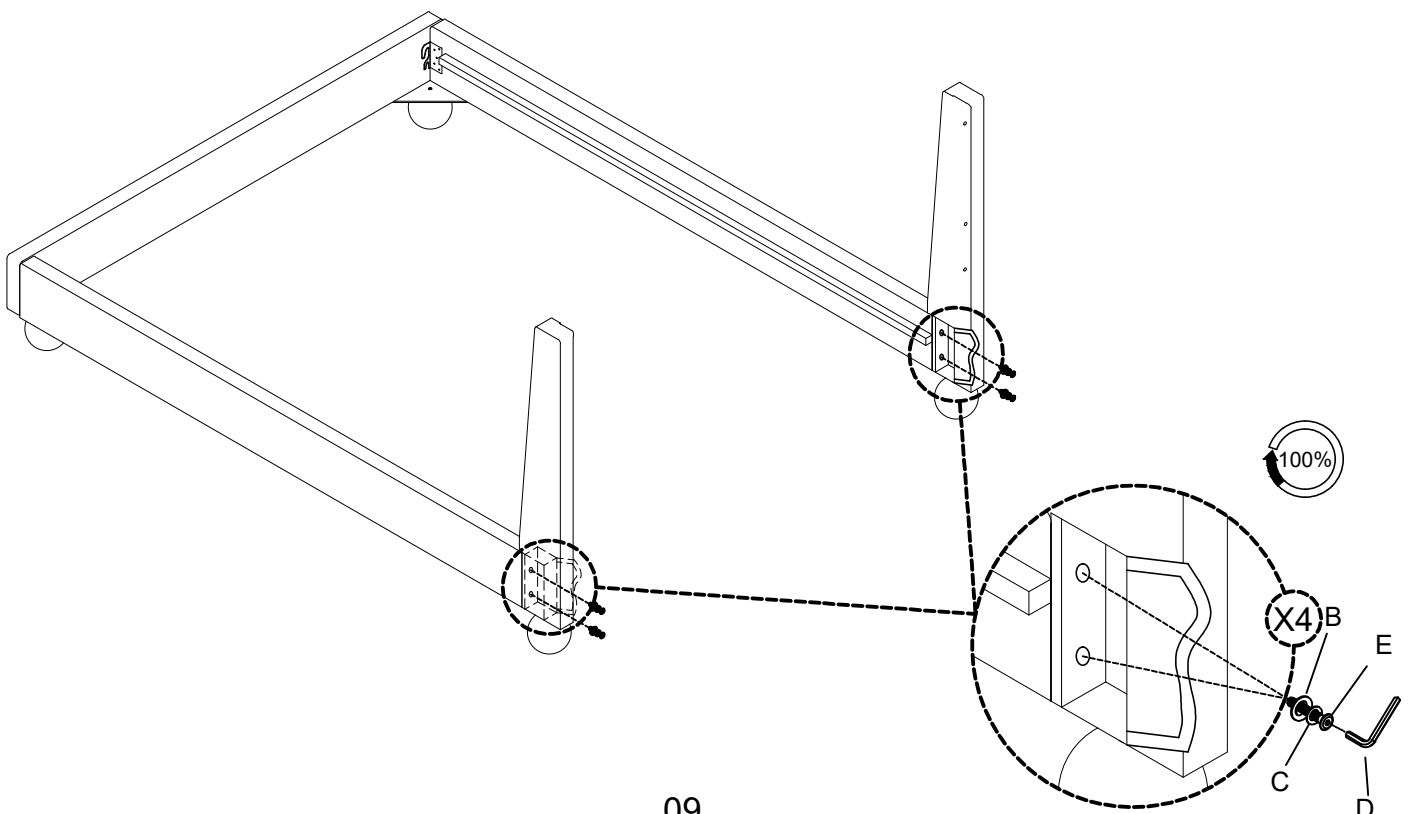

STEP 8 ÉTAPE 8

E x 4	B x 4	C x 4	D x 1
			





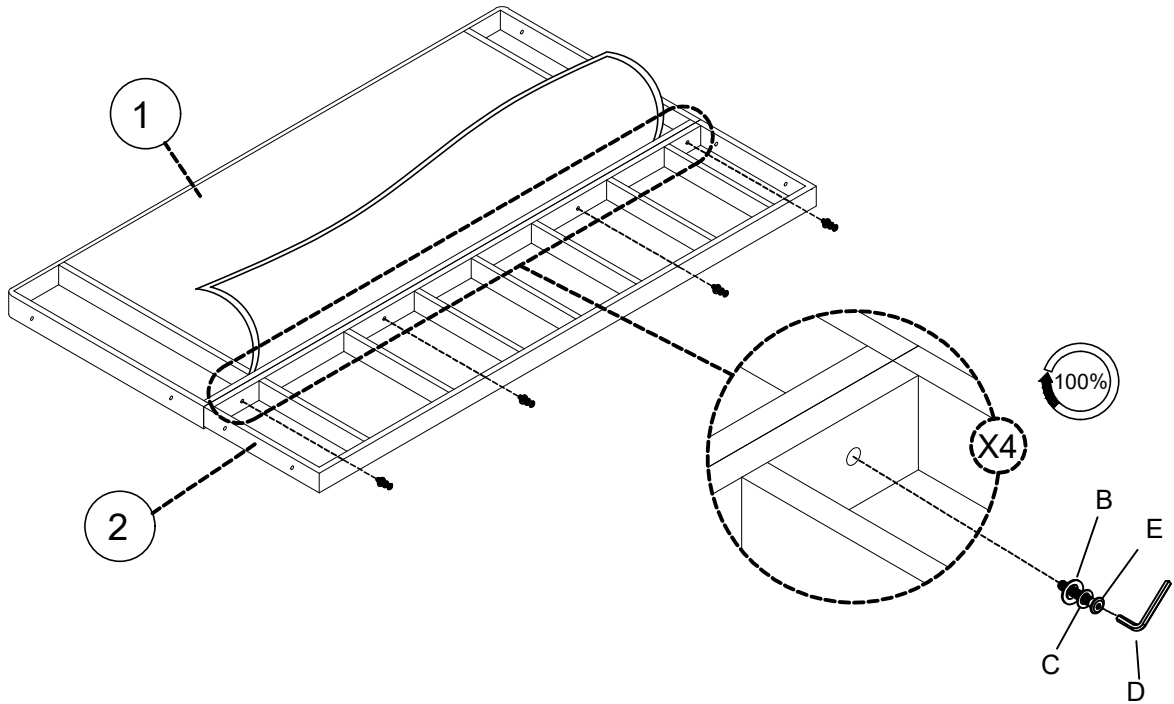

STEP 9 ÉTAPE 9

Ex 4	B x 4	C x 4	D x 1
			



STEP 10 ÉTAPE 10

Ex 8	B x 8	C x 8	D x 1
			

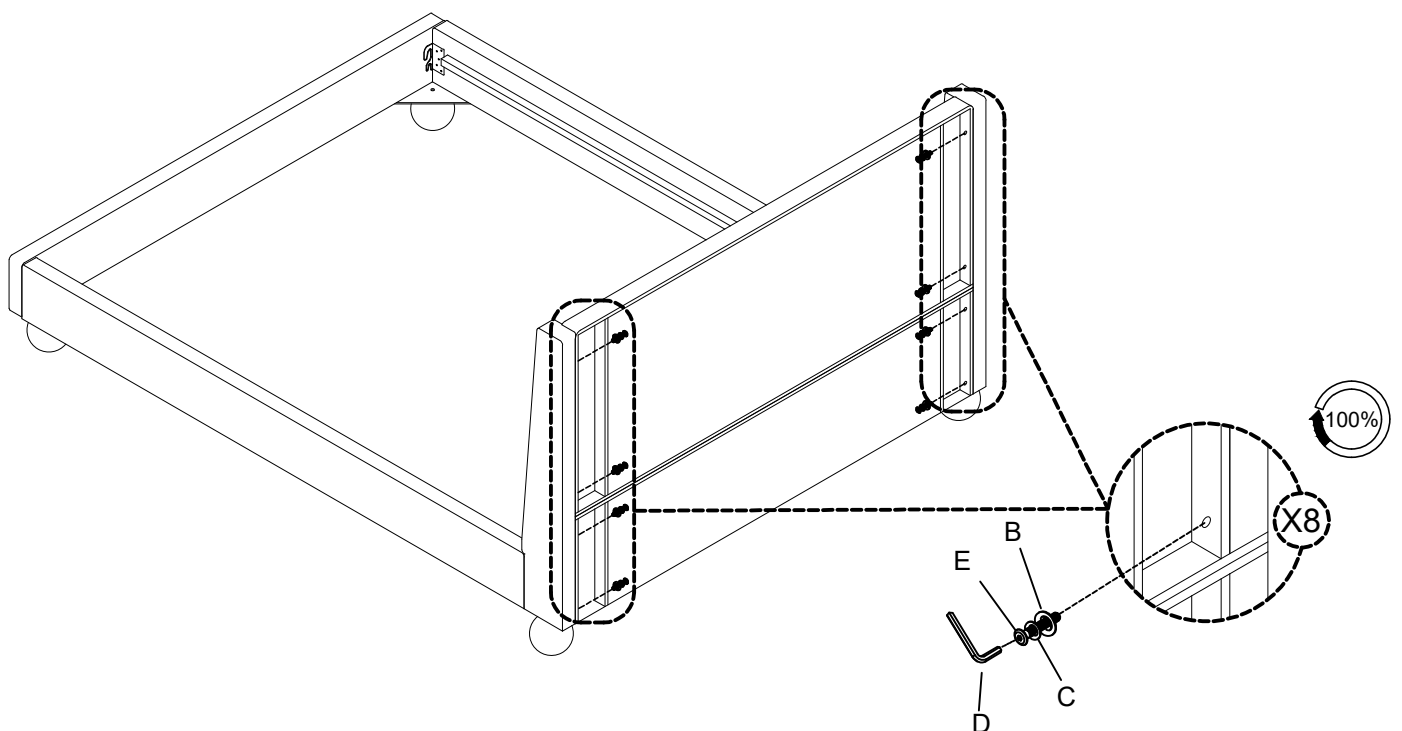

STEP 11 ÉTAPE 11

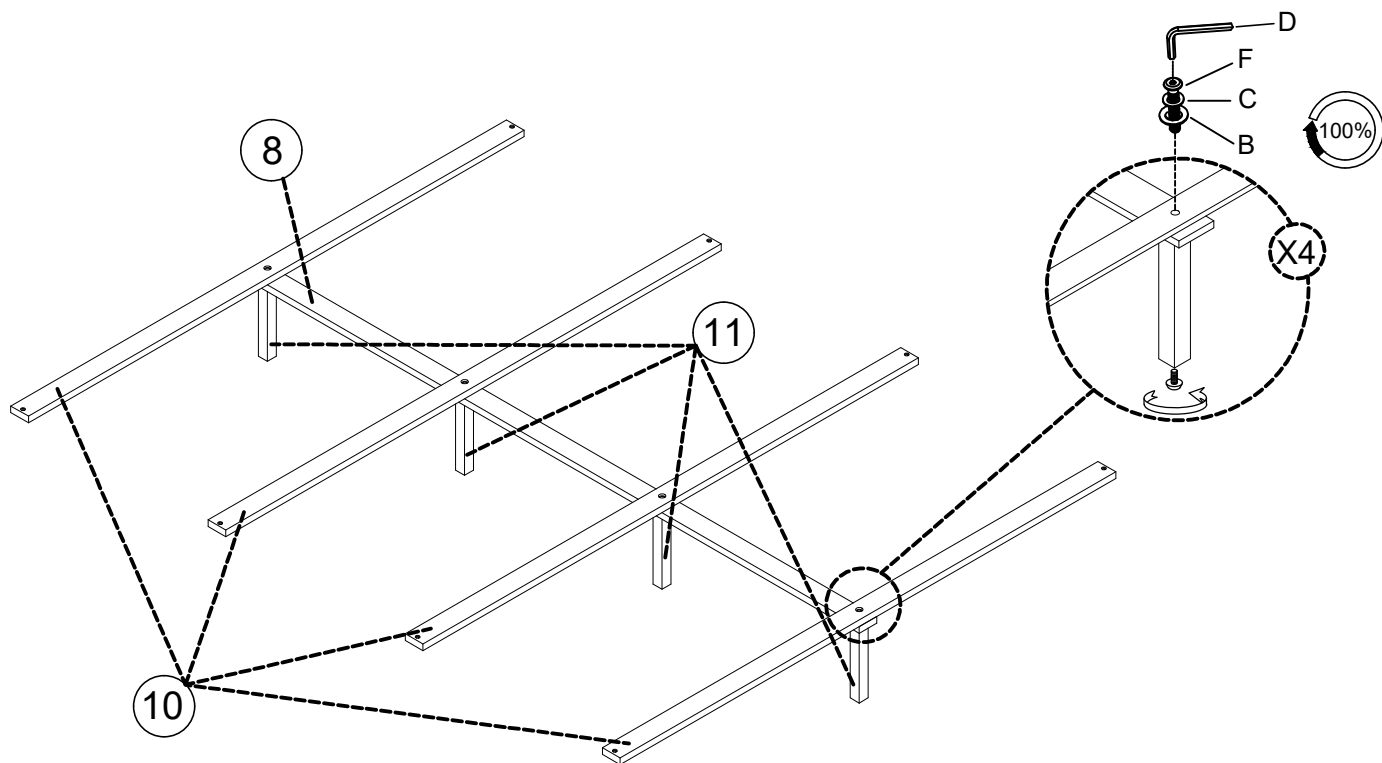
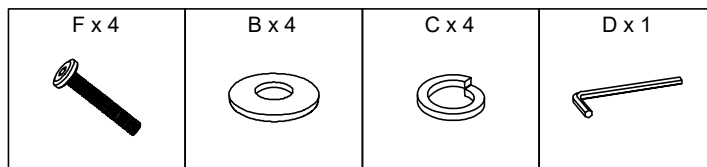

STEP 12 ÉTAPE 12

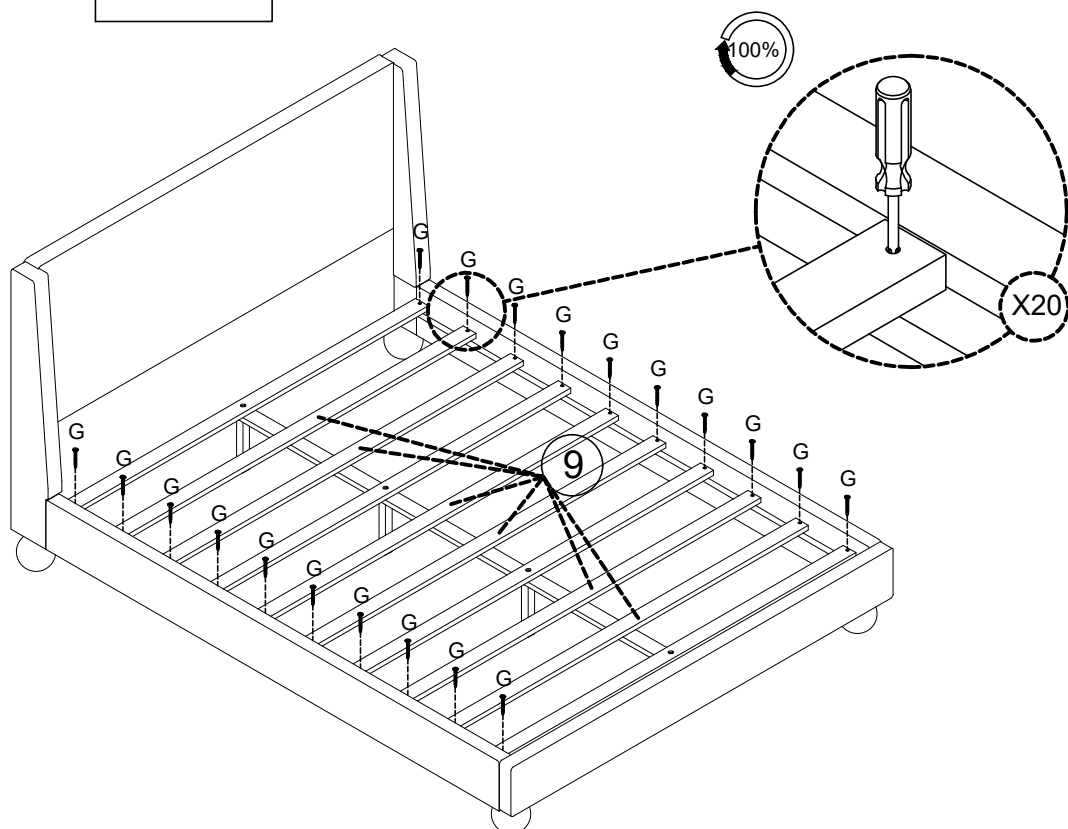
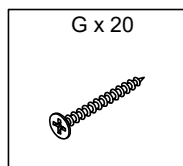

FINISH FINITION

