

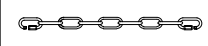

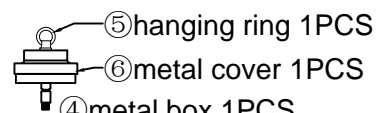

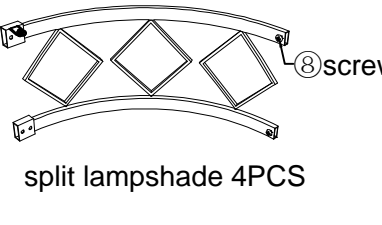

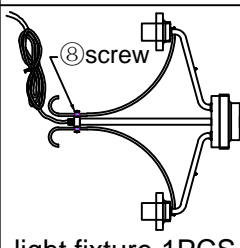
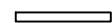

① canopy 1PCS  ② cap nut 2PCS	③ chain 1PCS 	④ metal box 1PCS ⑤ hanging ring 1PCS ⑥ metal cover 1PCS 	⑦ lock nut and teeth lock washer ⑧ screw ⑦ bended profile 4PCS	
⑨ split lampshade 4PCS 	⑩ light fixture 1PCS 	⑪ hanging tube 1PCS 	⑫ crystal chain 6PCS 	 X 1PCS
		⑬ crystal chain 12PCS 	⑭ crystal chain 1PCS 	 X 3PCS
		 X 3PCS	 X 3PCS	 X 3PCS

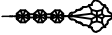
Note: male A should connect with femaleA, male B should connect with femaleB(C with C, D with D).



1. Loosen but not remove out the screw ⑧ of split lampshade ⑨, assemble the split part ⑨ to be a complete lampshade with screw ⑧, don't tighten the screw ⑧ until all split lampshade are ready against to each other, rotate to fasten the screws ⑧ at last.

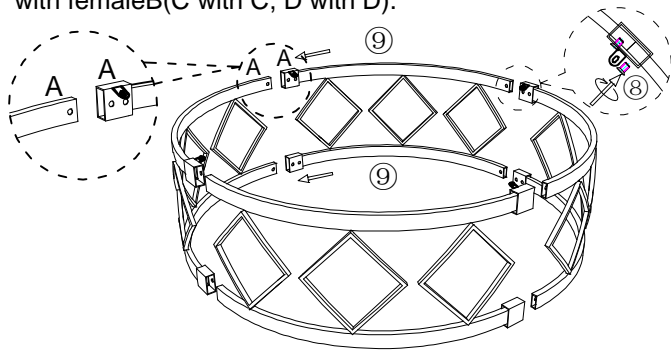
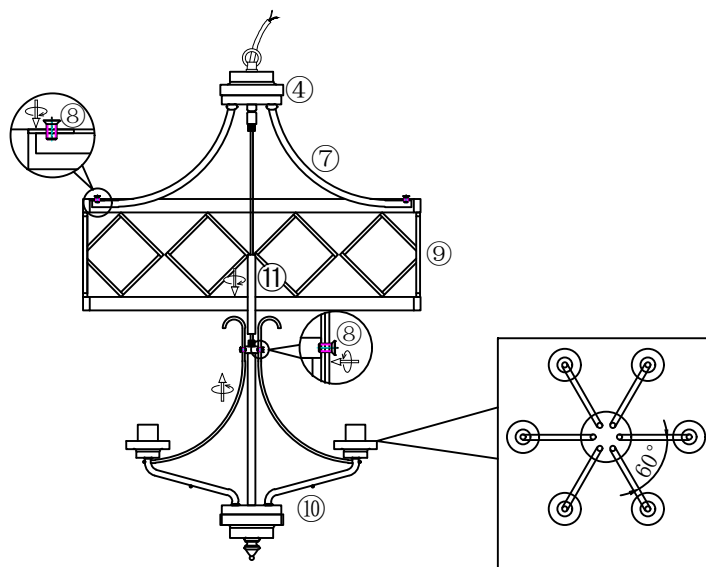

3. Install the metal frame ⑦ to the lampshade ⑨ with screw ⑧.  
 4. Rotate to loosen and remove out the screw ⑧ from light fixture ⑩, adjust the light arms 60 degree to each other, fasten the arms with screw ⑧.  
 5. Let the wire of the fixture go through the hanging tube ⑪, rotate to install the tube to the fixture.  
 6. Let the wire go through the box ④, rotate to fasten both parts together.

2. Rotate the ring ⑤ to loosen and remove out the ring ⑤ and cover ⑥ from metal box ④, install the profiles ⑦ to the box ④ with lock nut and teeth lock washer, close the cover ⑥ to the box ④ with ring ⑤.

7. Hang the fixture to the canopy ① with chain ③, let the wire go through the chain ③ and canopy ①.  
 8. Install the bracket to the ceiling junction box with screw ⑯.  
 9. Connect the wire to the home line with cap connector ⑮.  
 10. Install the fixture to the bracket with cap nut ②.  
 11. Hang the crystal chain ⑫, chain ⑬, chain ⑭ to the fixture like picture shown.  
 12. Install the bulb ⑰.

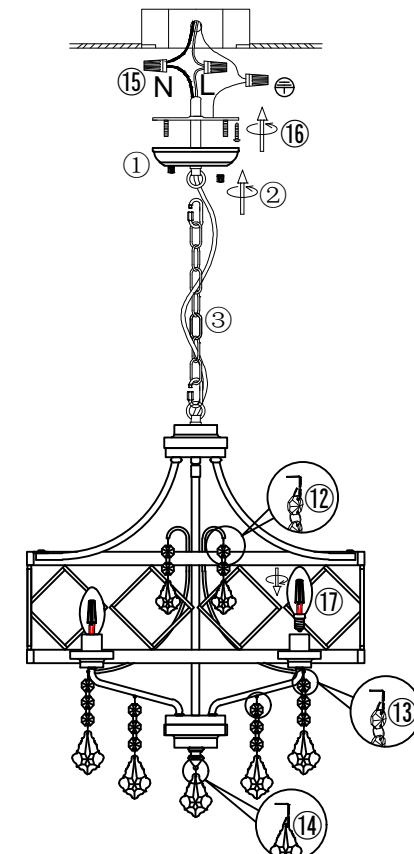

Please read carefully before installation!!!  
 Note : Please make sure that the electricity is powered off during installation !Only a professional electrician should install this kind of product !