

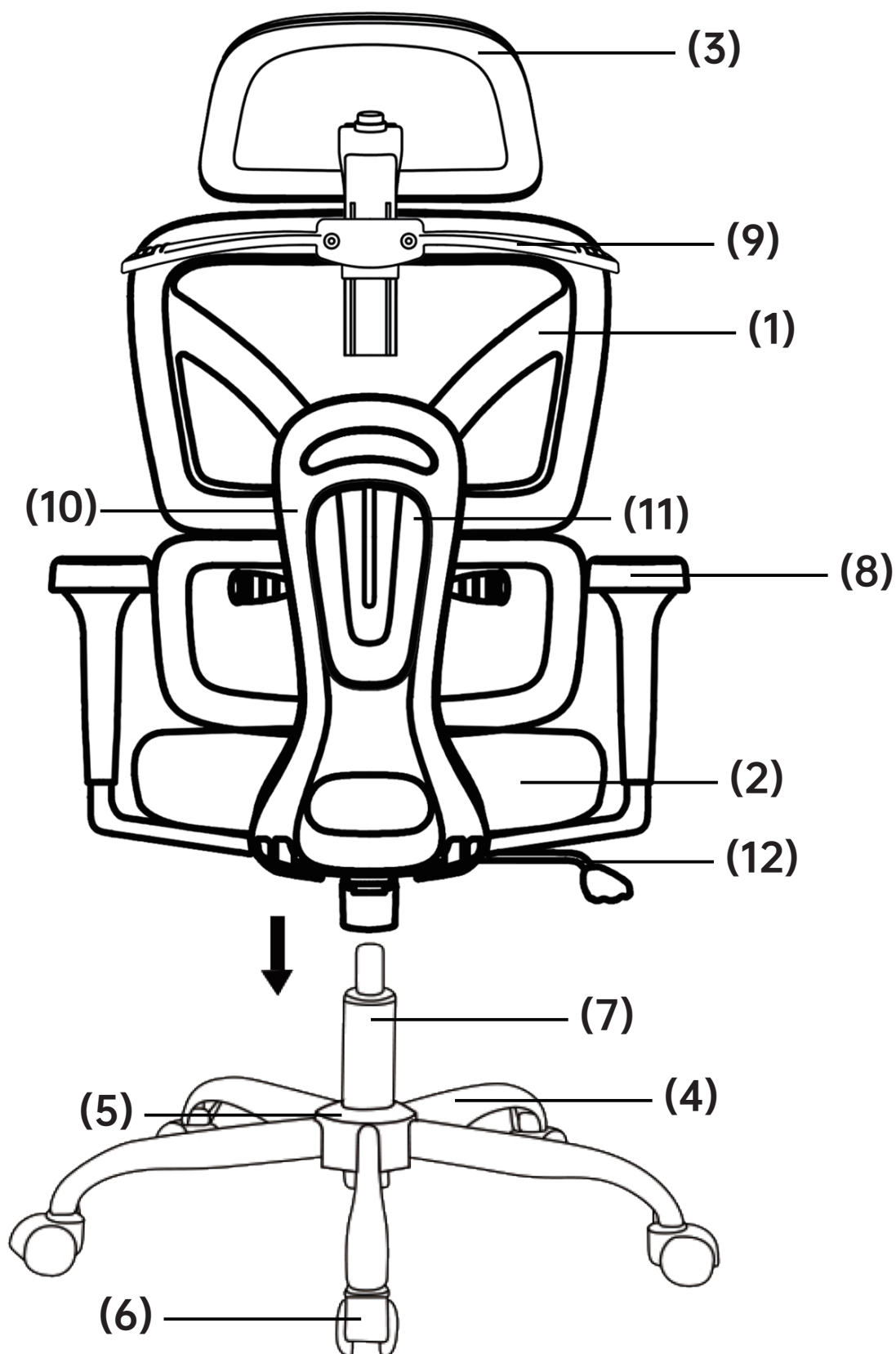

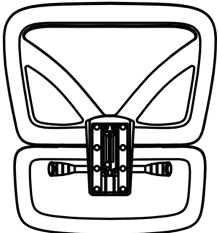







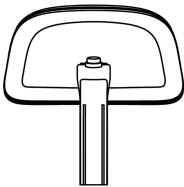

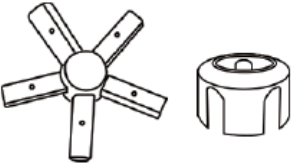

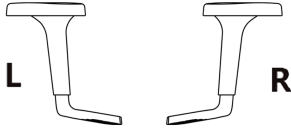

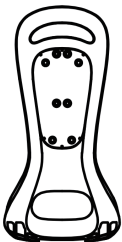

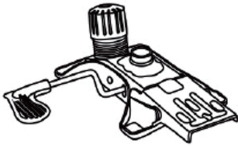
Product Overview

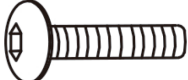

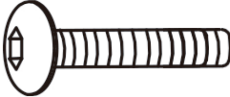
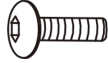
Accessories List

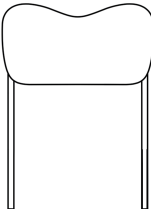
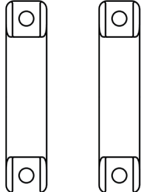
<p>(1) Backrest</p> 	<p>(2) Seat Cushion</p> 	<p>(3) Headrest</p> 	<p>(4) 5 Split Base Tube</p> 
<p>(5) Central Base Tube</p> 	<p>(6) 5 Castors</p> 	<p>(7) Air Rod</p> 	<p>(8) 2 Armrests</p> 
<p>(9) Clothes Rack</p> 	<p>(10) Backrest Support Shaft</p> 	<p>(11) Backrest Decorative</p> 	<p>(12) Base Plate</p> 
<p>(13) 5 Screws (M6X20mm)</p> 	<p>(14) 2 Screws (M6X25mm)</p> 	<p>(15) 2 Decoration Caps</p> 	<p>(16) 10 Screws (M6X30mm)</p> 
<p>(17) 8 Screws (M6X20mm)</p> 	<p>(19) 3 Screws (M8X35mm)</p> 	<p>(21) Footrest</p> 	<p>(22) 2 Footrest Mounting Slot</p> 
<p>(18) 1 Screws (M5X10mm)</p> 	<p>(20) Hexagon Wrench</p> 		

Assembly Instruction

STEP 1

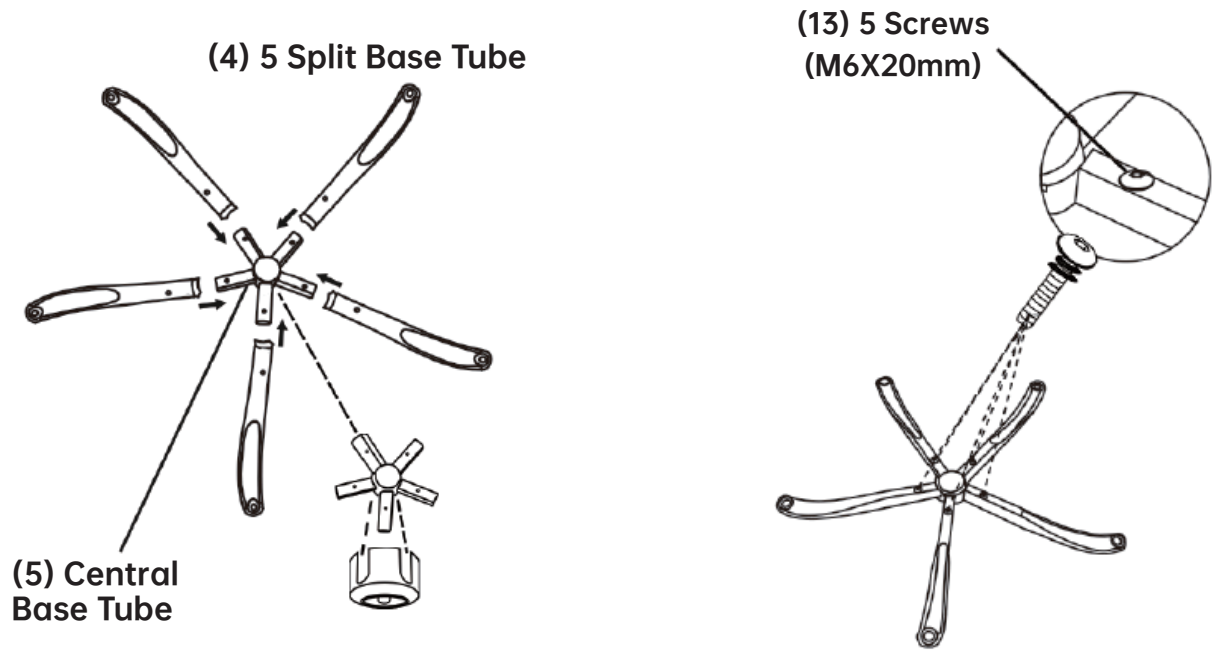

STEP 2

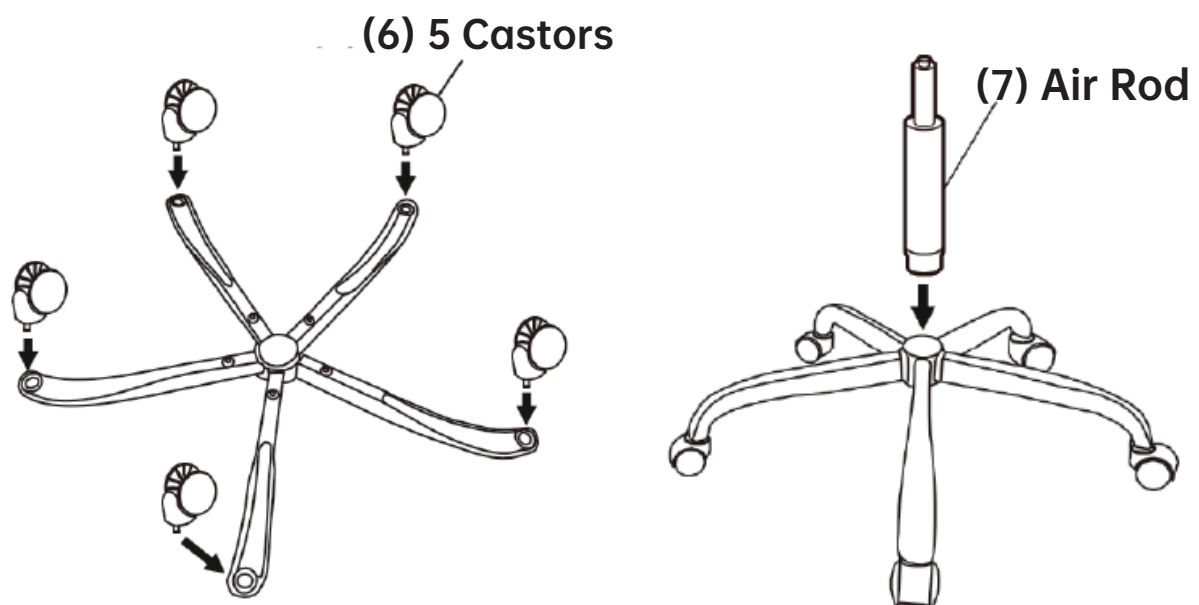

Assembly Instruction

STEP 3

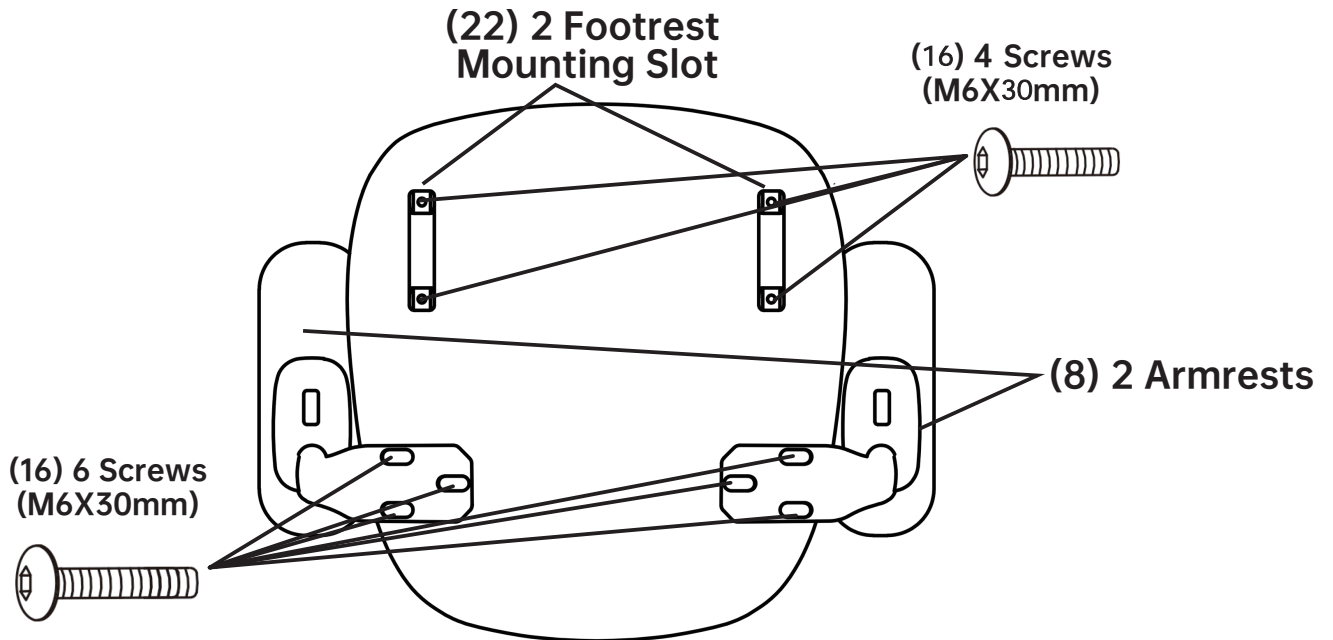

STEP 4

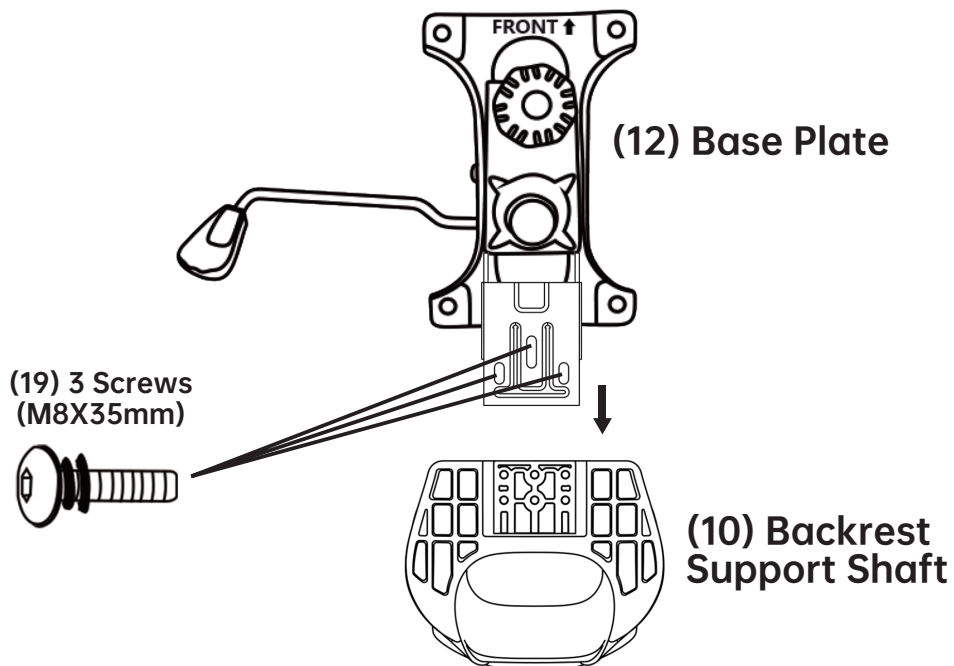

Assembly Instruction

STEP 5

(20) Hexagon Wrench



(17) 4 Screws
(M6X20mm)

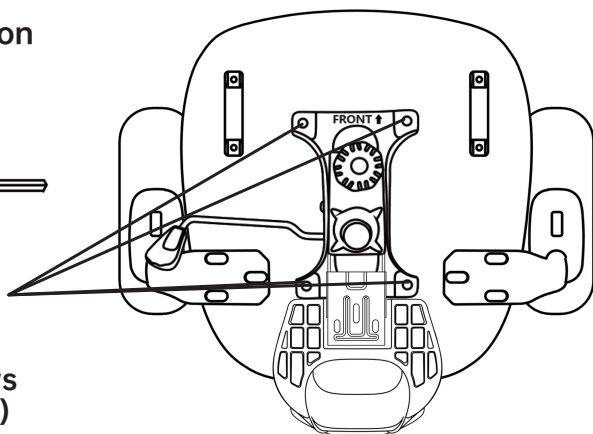
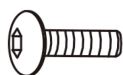

(21) Footrest

(18) 1 Screws
(M5X10mm)

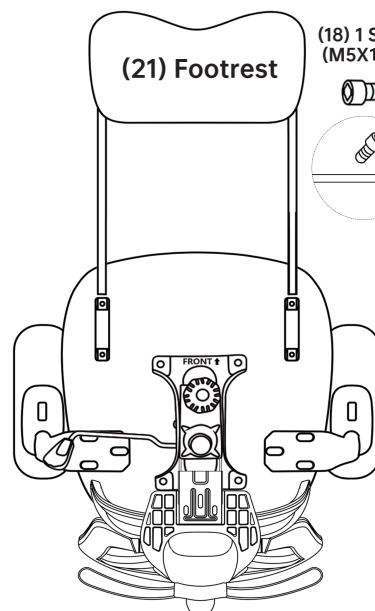
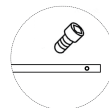

STEP 6

(17) 4 Screws
(M6X20mm)

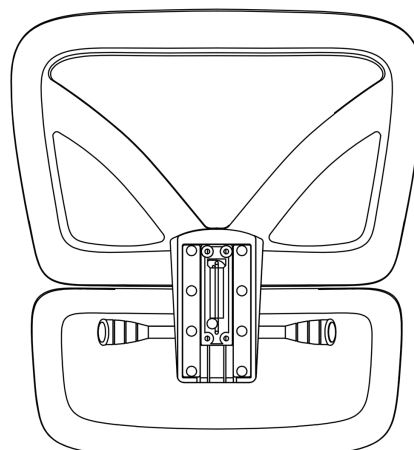
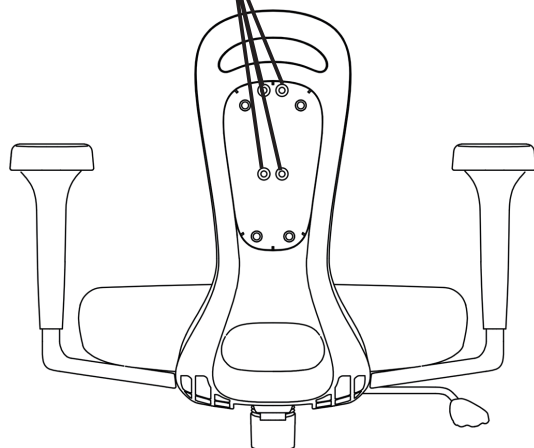

(1) Backrest

Assembly Instruction

STEP 7

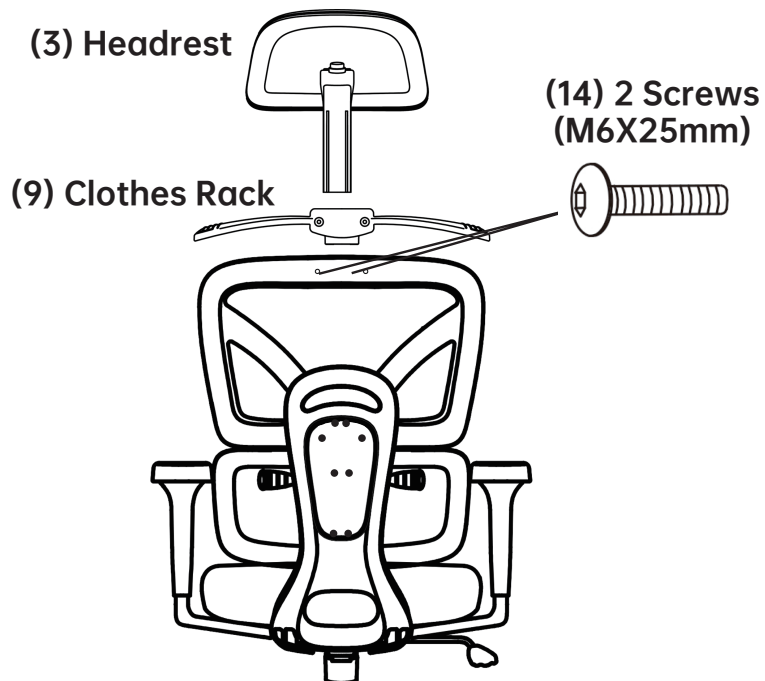

STEP 8

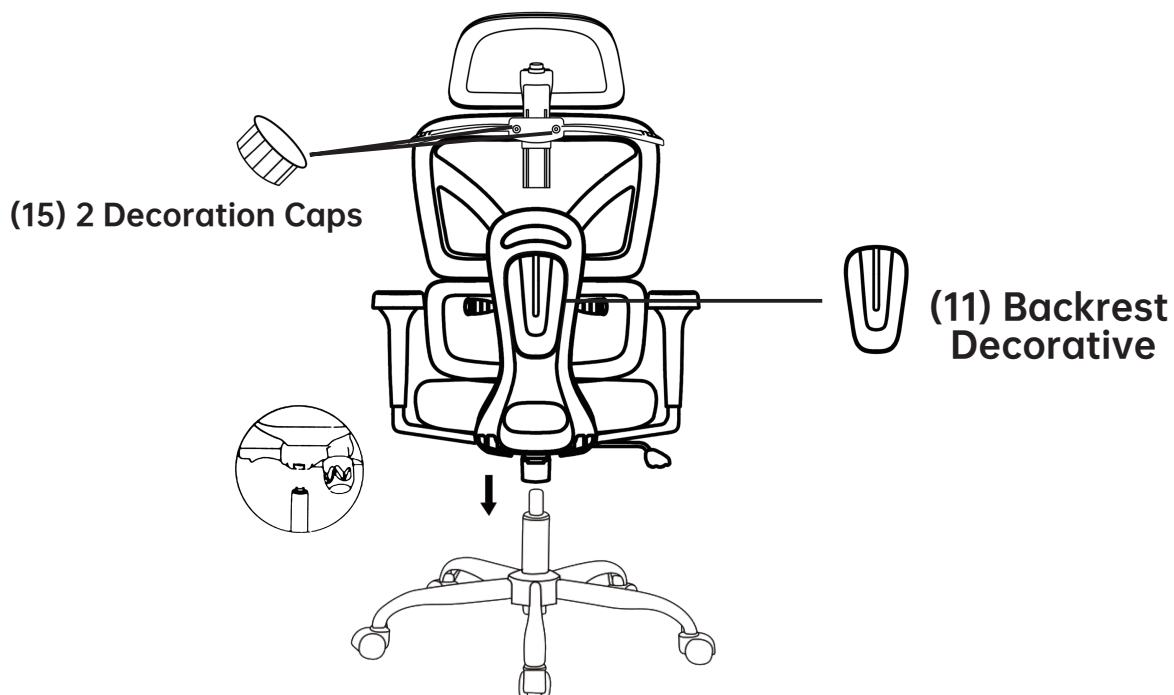

Assembly Instruction

STEP 9

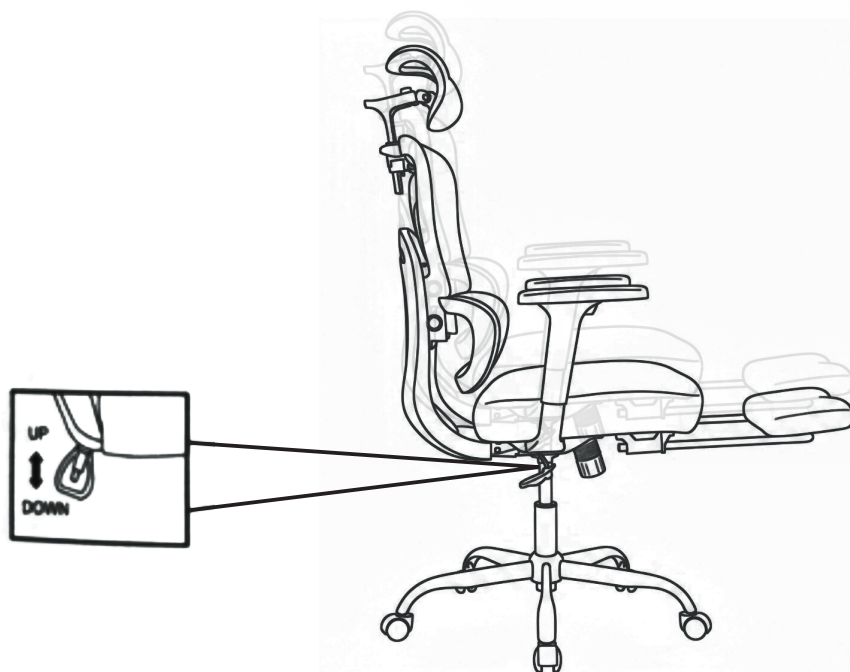

STEP 10

