

MESTYL

English

HZ006

Assembly Instructions

Sectional Couches

English

Assembly Instructions

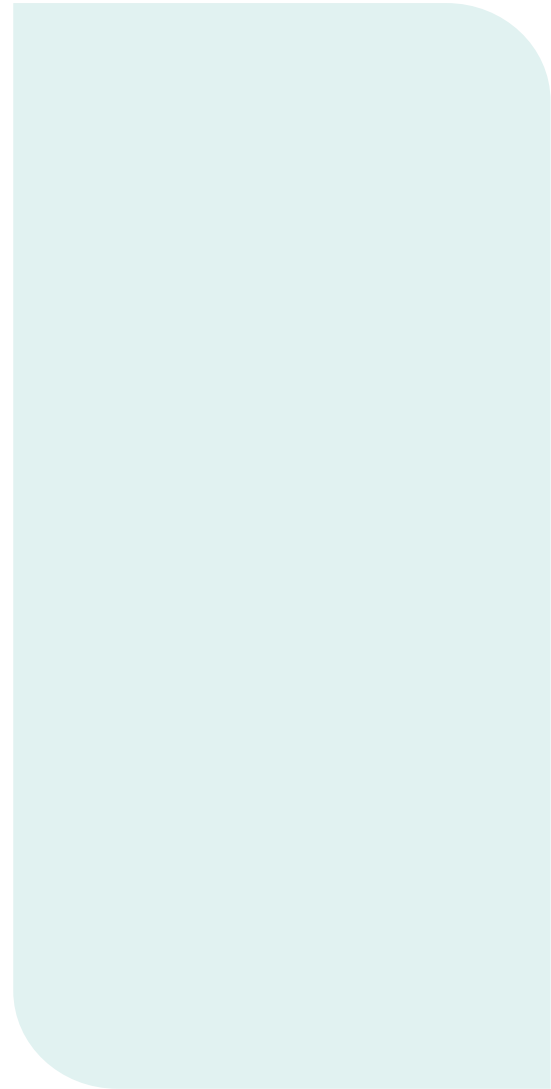



1-2

People Assembly



45~

Minutes Assembly



NOTICE:

- ◆ Please retain these instructions for future reference.
- ◆ Please read the instruction sheets completely before assembly. Remove all parts from the carton and ensure all components are included before assembly.
- ◆ Assemble the sofa on a protected surface to avoid scratching the components of the sofa. Be careful not to cross-thread screws.
- ◆ You can use a wooden hammer to help assemble to make sure the joints and tubes are assembled in position.
- ◆ Two people are recommended for assembly!
- ◆ When you assemble your sofa, if you smell a weird smell of the material, please don't worry it's very Normal. What you should do is to air it for 1 or 2 days on your balcony, patio, or near your window. MESTYL Sofas have been certified by the environment authority. So please don't worry it won't hurt your health, it's completely safe.

RETURN/DAMAGE CLAIM INSTRUCTIONS:

- ◆ This item is shipped in multiple separate boxes. If you only receive one box, please wait patiently for the rest of boxes. If you have not received the rest of boxes within two working days, please contact us immediately. Our email address is Mestyl@aliyun.com.
- ◆ If the package is damaged, please contact us as soon as possible and attach the damaged photo. Return Policy: This item can be returned within 30 days without any reason. If you return this item for personal reasons, you need to bear the freight of returns and order processing fee (0-50% restocking fee based on the invoice price). If the product has quality issues (not caused by humans), we will bear the freight.
- ◆ If you need to return the goods, please keep the original box. Please make sure to use the return label provided by us and do not return it without permission. Please do not share a label with multiple boxes.
- ◆ If you return the product after 30 days from receiving it, we are afraid that your return application won't be accepted. We appreciate your understanding.
- ◆ The warranty product is one year. If this item is damaged within the warranty period we will arrange you the replacement parts free of charge. If the item is damaged for some personal reasons, we could also replace it for you, however you need to bear the transport fees.

CLEANING AND MAINTENANCE OF LEATHAIRE SOFA

- ◆ The washing method of the leathaire sofa should be dry cleaning to prevent shrinkage deformation. Please do not bleach. Leathaire sofa vacuum at least once a week, paying particular attention to removing dust between fabric folds.
- ◆ If you accidentally stick to the beverage, coffee, tea stains on the sofa, please wipe the surface of the leathaire sofa with the mixture of white vinegar and baking soda. Please use a dry cloth to wipe off the moisture on the surface after wiping.
- ◆ Please gently pat and tidy the cushions and backrests of the sofa frequently to keep them beautiful.
- ◆ Please note that the leathaire sofa is not machine washable, as it is a kind of nano sealing glue technology. Please do not tear it with great force. It will destroy the sealing glue on the surface of leathaire fabric, resulting in damage on the surface of the fabric and more serious damage.
- ◆ If wrinkles occur, please iron it with a steam iron at a temperature between 158°F and 176°F.



CLEANING AND MAINTENANCE OF FAUX LEATHER SOFA

- ◆ Please use leather-specific cleaners and care solutions for comprehensive cleaning and care after first purchase. PU sofa should be placed in a suitable temperature, ventilation place where the sun cannot shine directly to avoid leather discoloration or discoloration.
- ◆ Clean the sofa regularly with a clean white cotton cloth. The leather surface can be applied evenly with a special leather cleaner or glossing agent, and then dried later with a clean, soft cloth. Prohibit the use of oily leather care solutions.
- ◆ if you accidentally soiled tea, drinks, soup on the sofa, please wipe clean with a clean white cotton cloth in time. If there are traces of residue, please use a special cleaning agent or tableware cleaner water (cleaner, water: 1: 10), dilute it and then dry with a clean white cotton cloth. Please gently pat and tidy the cushions and backrests of the sofa frequently to keep them beautiful.
- ◆ The surface of the sofa is easily contaminated by grease and sweat from the skin, hair, dirty hands, and dirty clothes. It is recommended to put a piece of decorative cloth on the head and arms to protect the sofa.
- ◆ If wrinkles occur, please iron it with a steam iron at a temperature between 158°F and 176°F.



CLEANING AND MAINTENANCE OF FABRIC SOFA

- ◆ Fabric sofa should be regularly removed with a vacuum cleaner or brush to prevent dust or stains from staying on the fabric for a long time. Fluffing the seat cushions and pillows every week, whether in use or not, will help adjust the density of the padding so that it is even and fluffy back to its natural state. Especially when you often sit in the same position, you need to frequently change the position of the seat cushion to make the cushion force uniform.
- ◆ If you accidentally stick to the beverage, coffee, tea stains on the sofa, please wipe it with a white cotton cloth or absorbent paper towel. If there are residual traces, please wipe the stain with 50% of water and 50% of the solvent of white vinegar. and then clean the stain with neutral soap, or wipe the stain with a piece of soaked cotton cloth. Then use a dry white cloth or absorbent paper towel to absorb the remaining liquid, and finally dry it gently with a blower.
- ◆ If you accidentally splash oil on the sofa, please use absorbent paper to gently wipe off the residual oil. Please gently wipe stains with a piece of pure ethane alcohol soaked in a cotton cloth, do not rub, and then use a dry cloth or absorbent paper towel to suck away the residual liquid.
- ◆ Stains such as handwriting and ink should be dealt with immediately when they are first produced. The longer its on the fabric. the harder it is to remove.
- ◆ The cleaning method of fabric sofa covers is dry clearing, and bleach water cannot be added. The fabric sofa covers need to be ironed after washing, and the ironing temperature is between 158°F and 176°F.
- ◆ If wrinkles occur, please iron it with a steam iron at a temperature between 158°F and 176°F.



TIPS

- ◆ Don't tighten the screws one after another immediately until all screws are lined up with holes. Leave some space for adjustment.
- ◆ Screws may be not lined up with the holes. However, if that happens, please loose the screws a little and then tighten them in a diagonal way again.
- ◆ If the product is uneven or unstable after assembly, please loosen the screws, and put strength on it to make sure that all the legs are at the same level. Go on assembling it.
- ◆ Remove all parts from the carton and place them on a protected surface or carpet.

Part List

Carton SFHZ-006A03-A

x 1

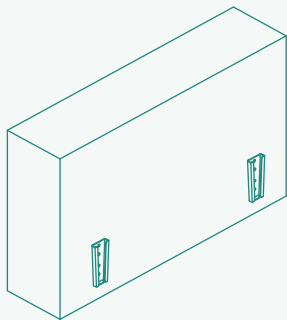

A Left Armrest

x 1

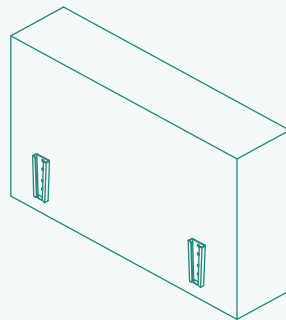

B Right Armrest

x 2



M Back Cushion

Part List

Carton SFHZ-006A03-B

x 1

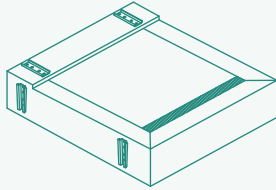

C Left Seat Base

x 1

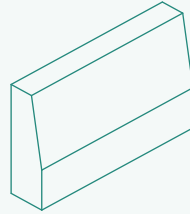

D Backrest

x 1



E Seat Cushion

x 1

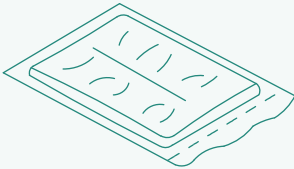

F Back Cushion

x 4

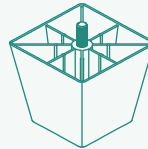

1 Legs

x 4



2 Washer

Part List

Carton SFHZ-006A03-C

x 1

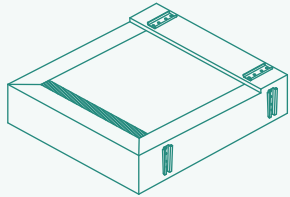

G Right Seat Base

x 1

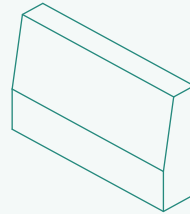

D Backrest

x 1

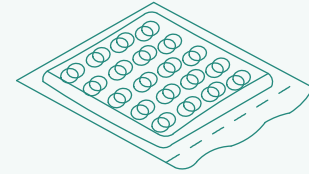

E Seat Cushion

x 1

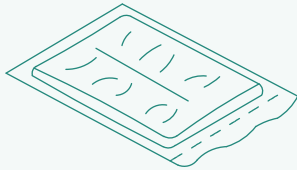

F Back Cushion

x 4

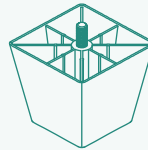

1 Legs

x 4



2 Washer

Part List

Carton SFHZ-006A03-D

x 1

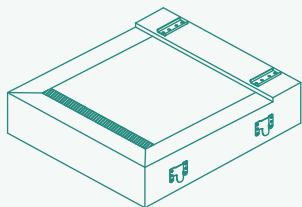

H Loveseat

x 1

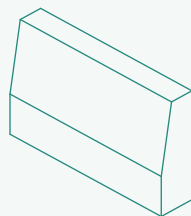

D Backrest

x 1

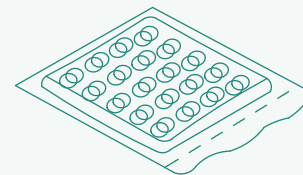

E Seat Cushion

x 1

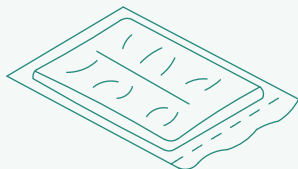

F Back Cushion

x 4

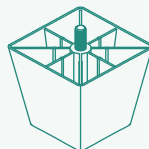

1 Legs

x 4



2 Washer

Part List

Carton SFHZ-006A03-E

x 1

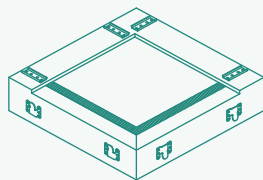

I Corner

x 2



J Cushion

x 1

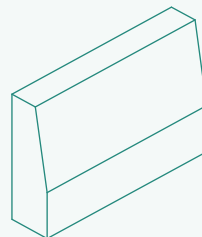

K Corner's Backrest

x 1

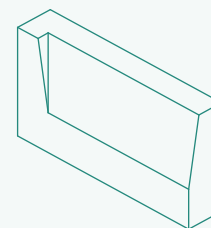

L Corner's Backrest

x 1



N Seat Cushion

x 4



1 Legs

x 4



2 Washer

Step 1

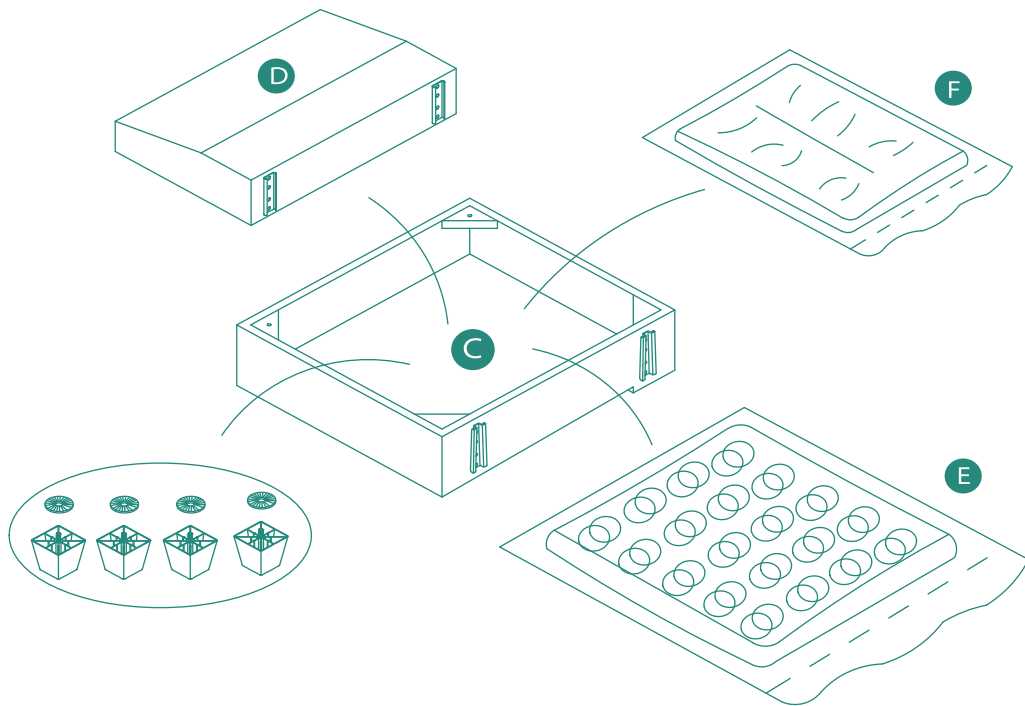

Step 2

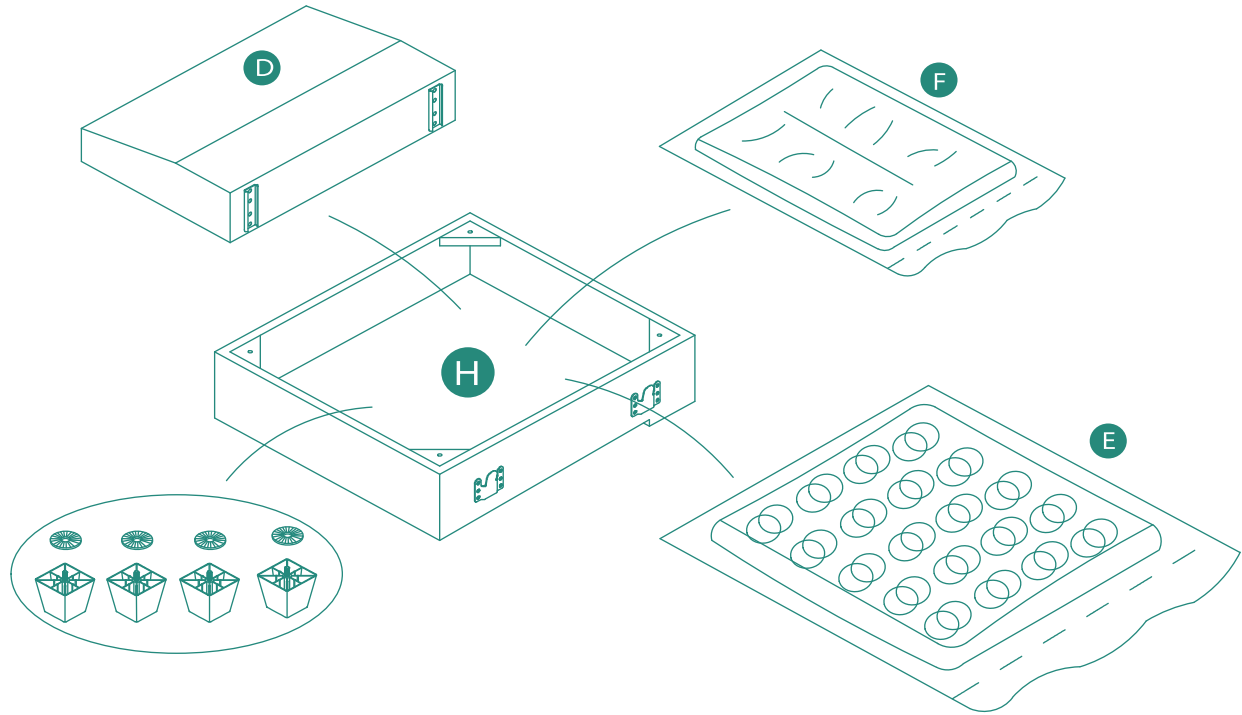

Step 3

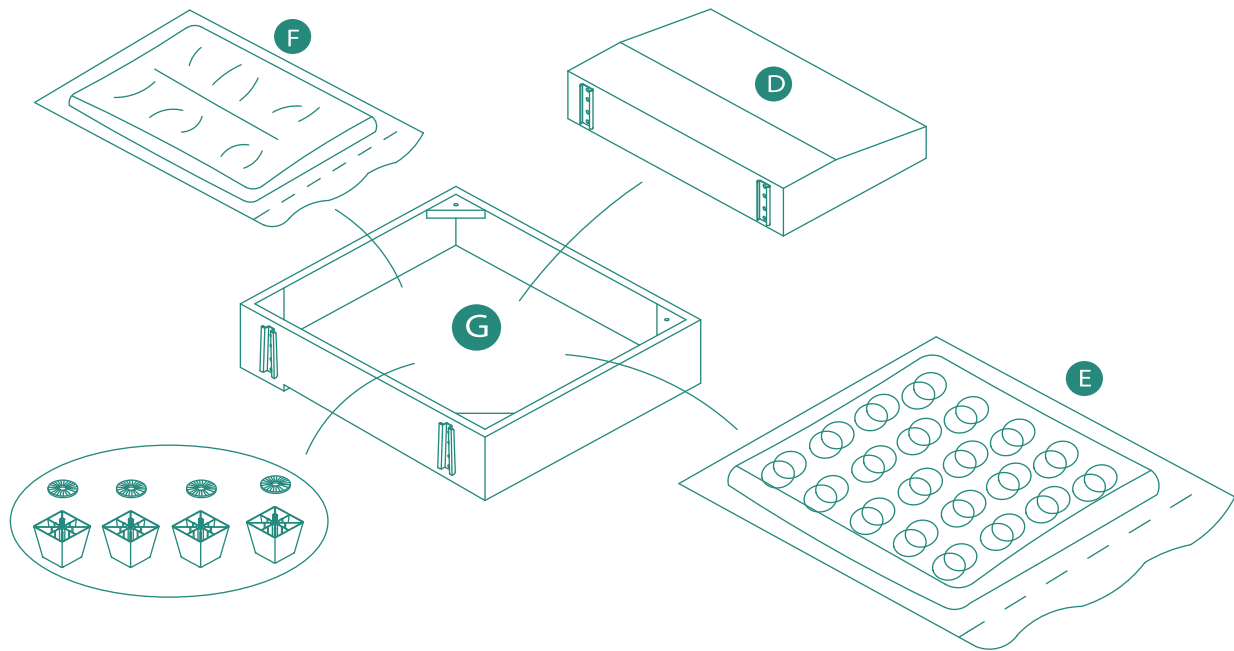

Step 4

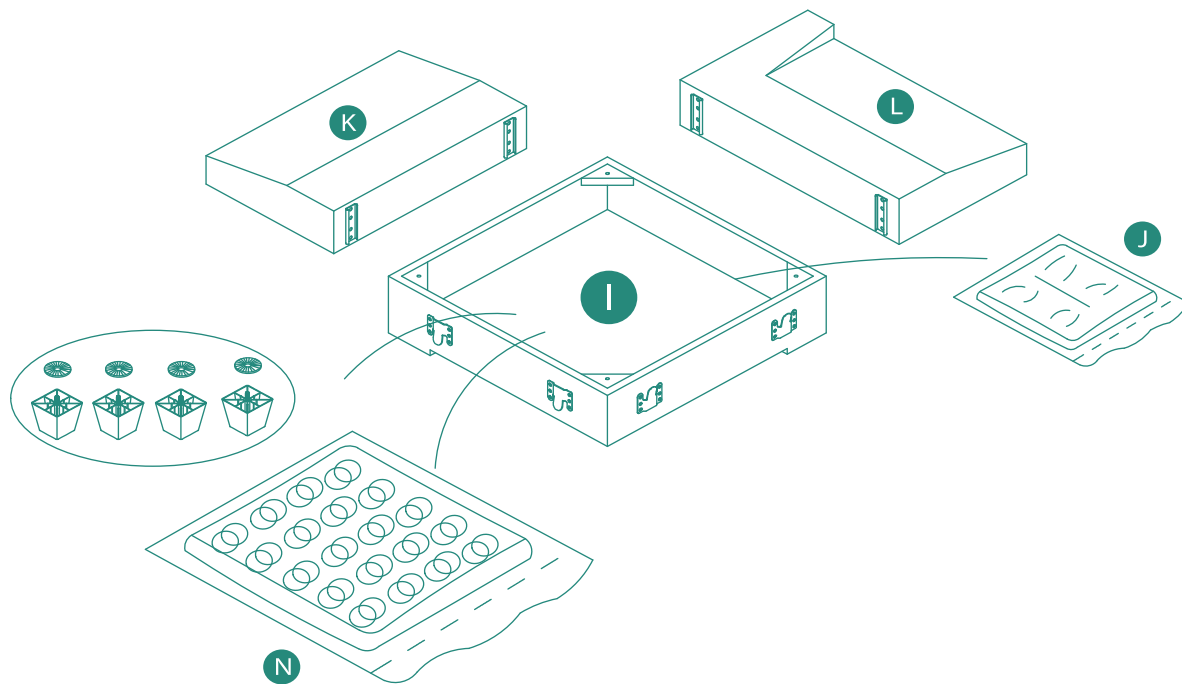

Step 5

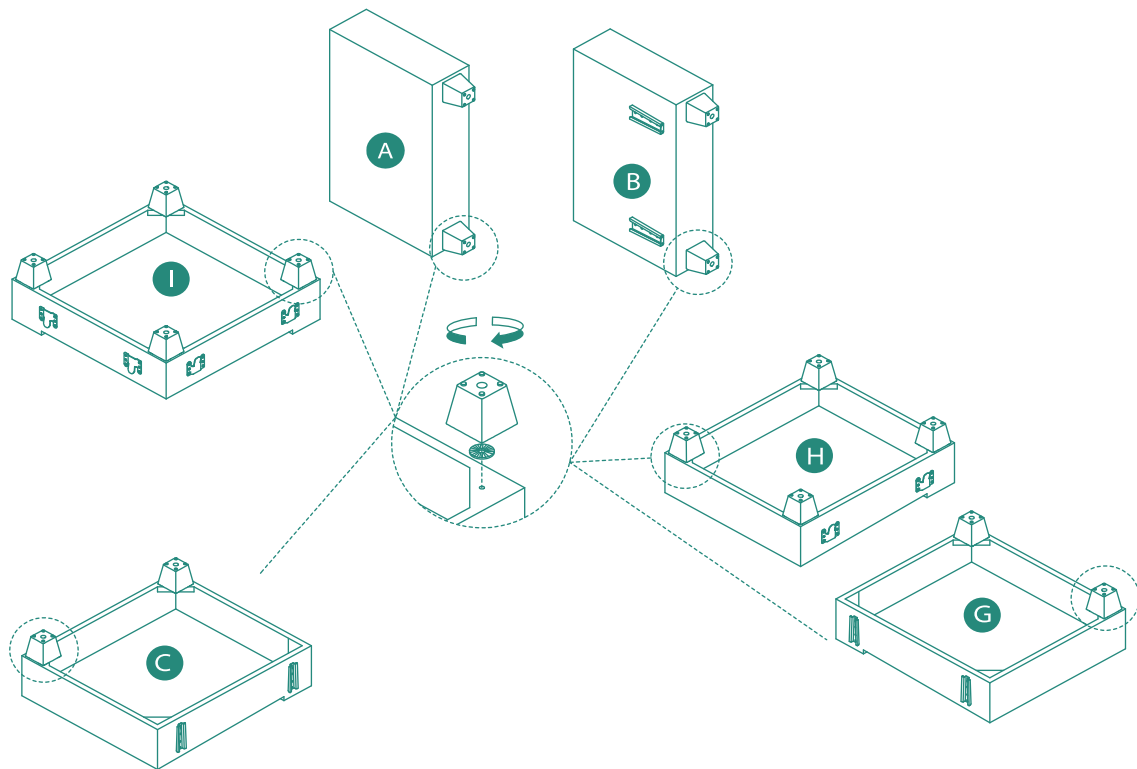

Step 6

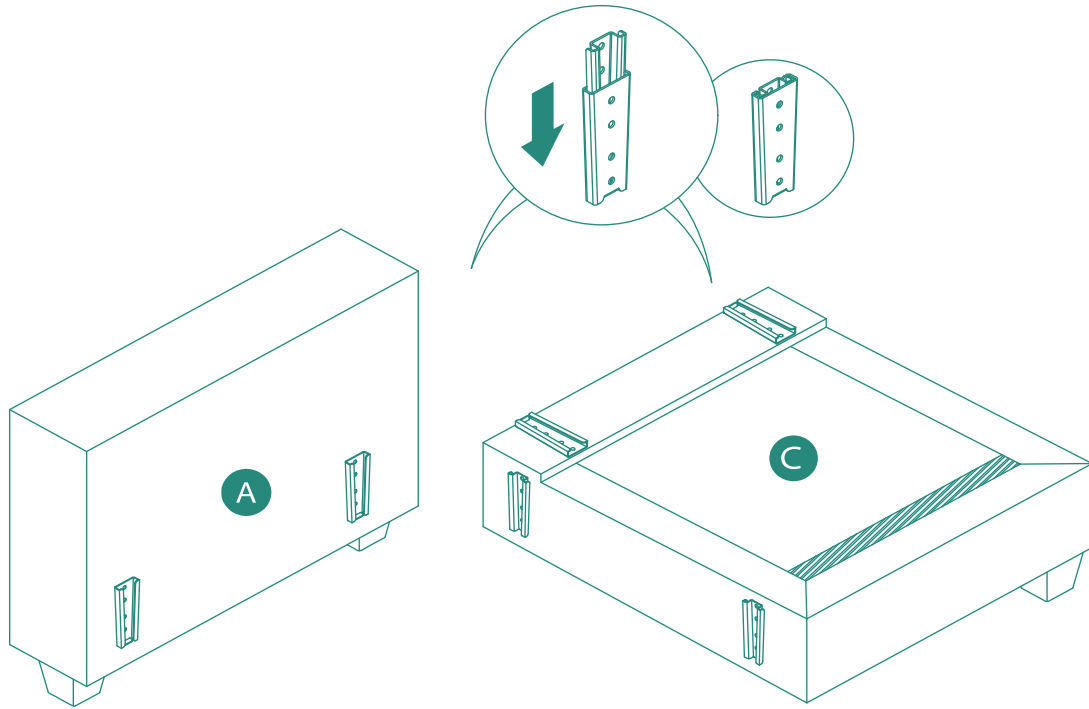

Step 7

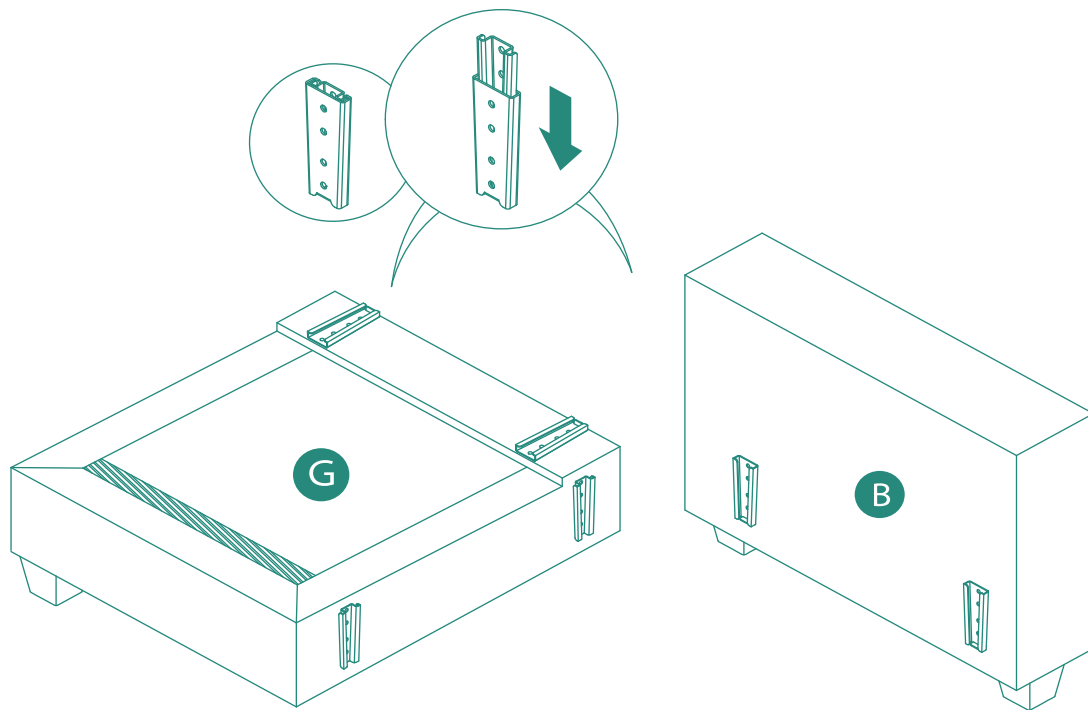

Step 8

TIPS:

- Please install the parts in the order of the numbers on each part on the diagram.
- Lift up the E cushion to make it easier to assemble the connectors.

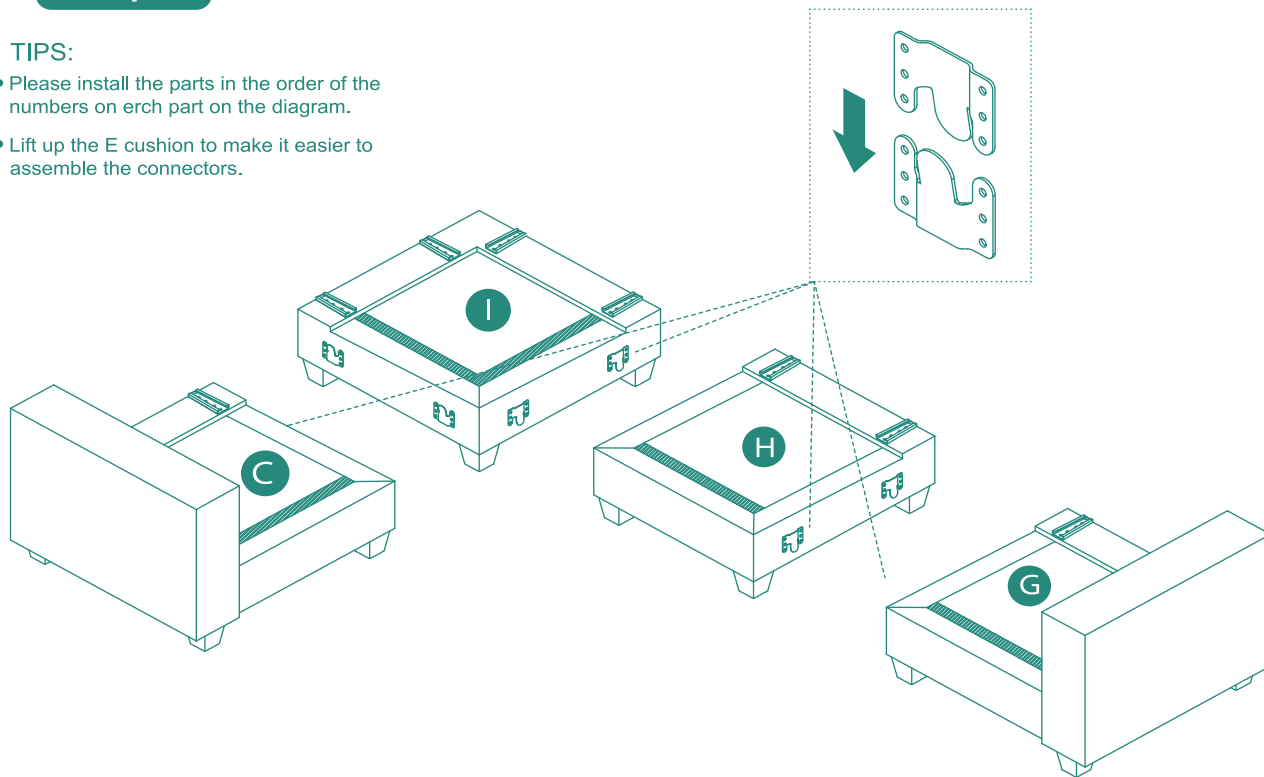

Step 9

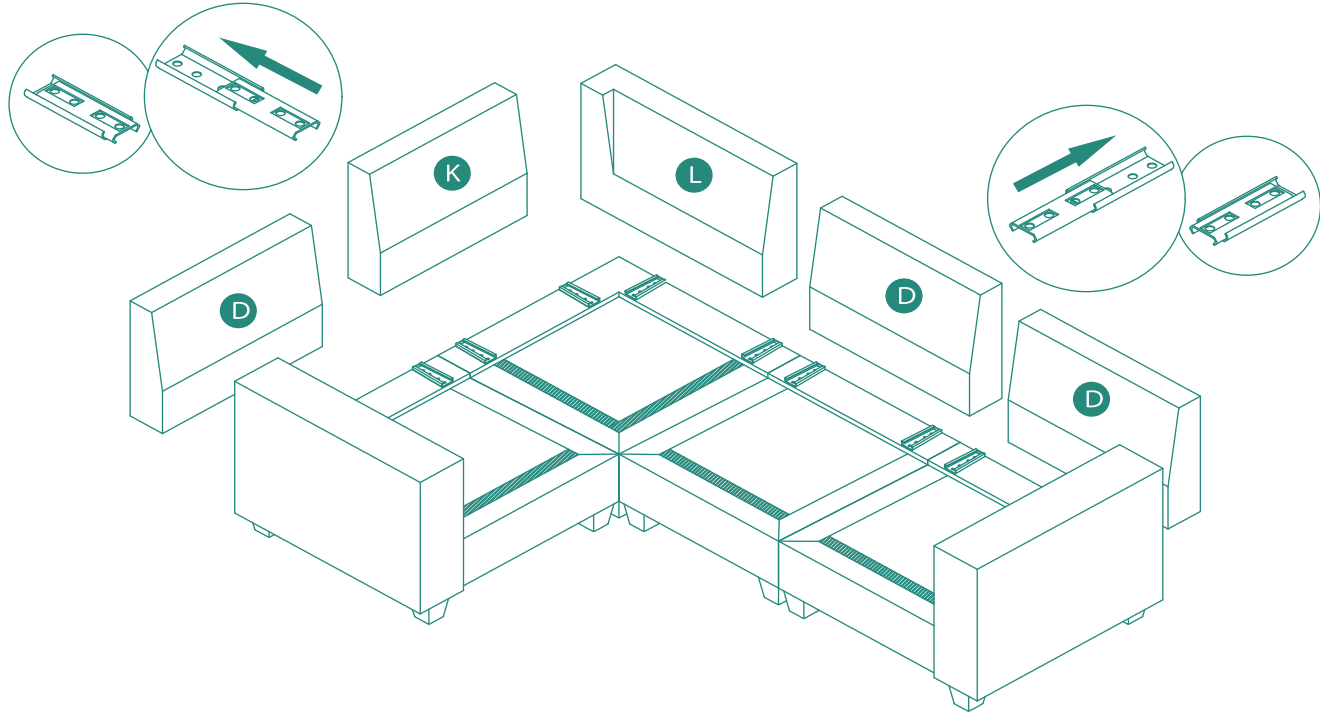

Step 10

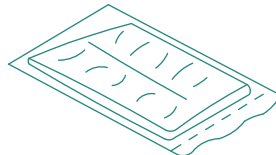
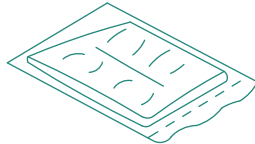
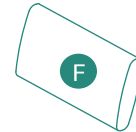
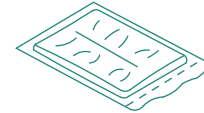
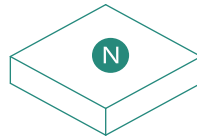
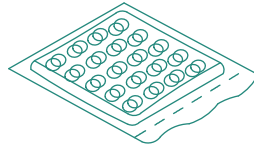
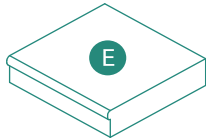
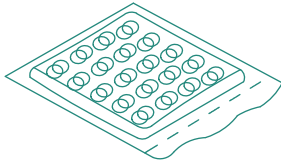

Step 11

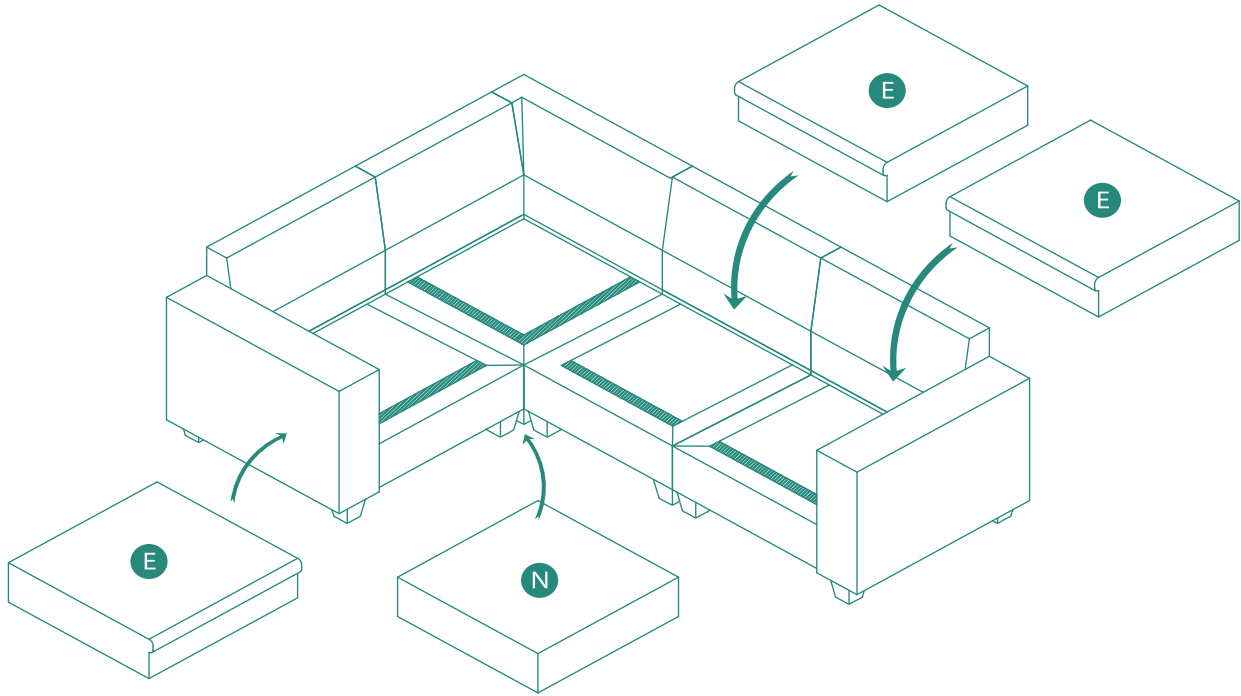

Step 12

Put on all back cushion

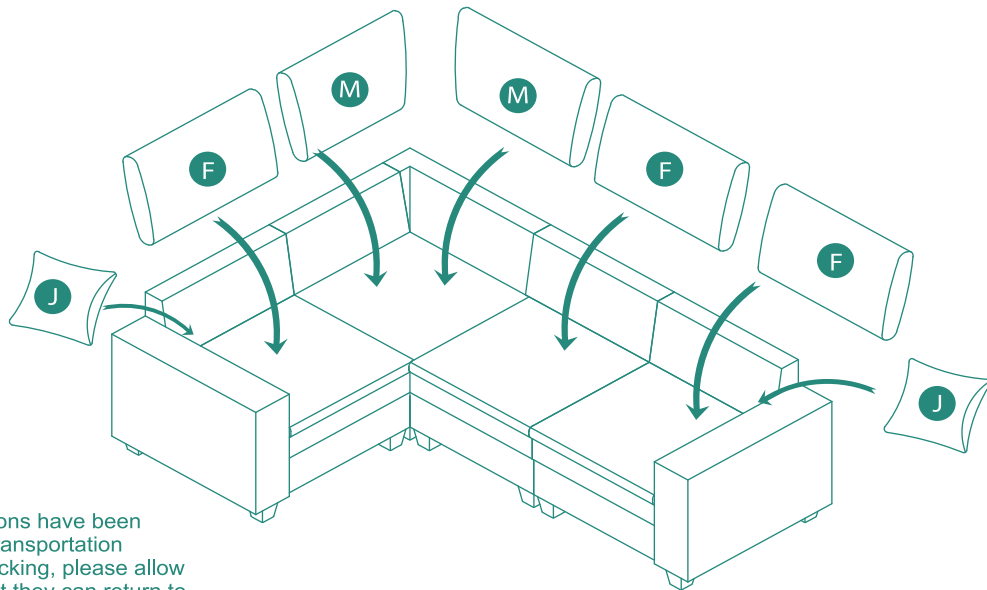

⚠ Note: The seat cushions have been vacuum packed for transportation purposes. After unpacking, please allow up to 72 hours so that they can return to their original shape.

Step 13

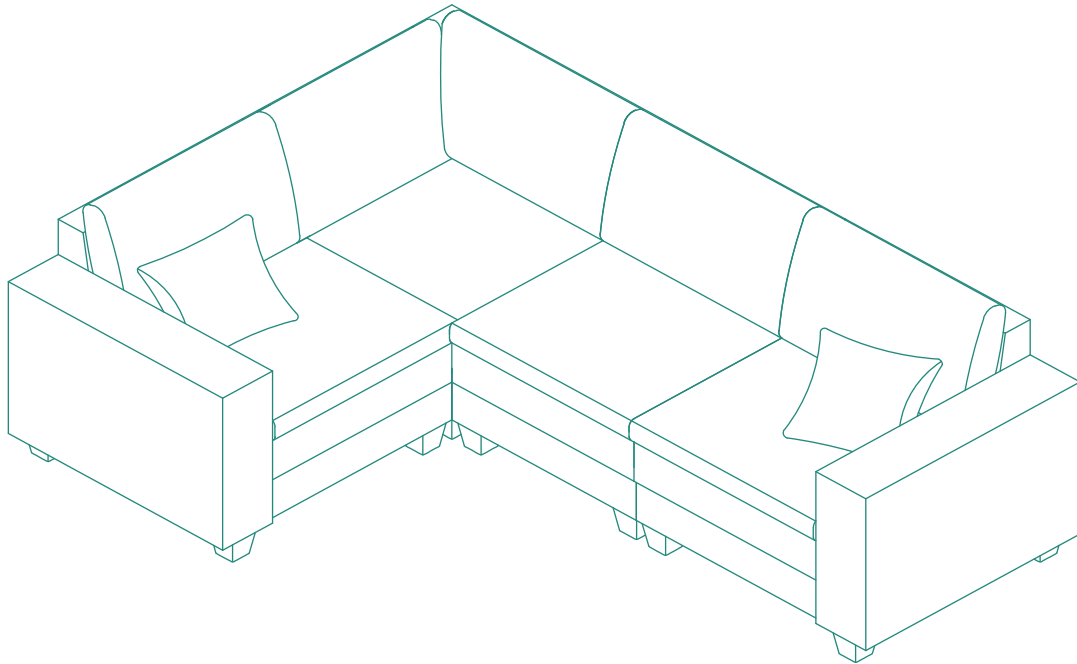

About

MESTYL

The MESTYL brand is committed to the design and application of furniture, creating applicable high-quality so far for the diversity of interior space, and we focus on offering customers good shopping experience and professional customer service.

Customer Service: Mestyl@aliyun.com

LIMITED WARRANTY

Our team would like to improve the quality of the customer service and make your experience as easy and smooth as possible.

Return Policy: This item could be returned within 30 days without any major reason. After we receive the returned item, we would check it and make sure that is not damaged then we will process the refund. For more details, please remember to check the above terms of RETURN/DAMAGE CLAIM INSTRUCTIONS.

The warranty product is one year from the date of your purchase. If this item is damaged within the warranty period, we will arrange for you the replacement parts free of charge. If the item is damaged for some personal reasons, we could also replace it for you, however, you would need to bear the cost of the replacement parts and shipping fees.

The exceptions or exclusions to this warranty are as follows:

Any warranty claim that is submitted after the limited warranty period won't be taken into consideration. We wouldn't be able to replace the item for you even at your cost.

This warranty does not the products which have been purchased by mistake.

In the case of having some defect in the material or handiwork that are covered by this item's warranty, MESTYL will repair replace it for you without charging you any cost within a reasonable period of time. We reserve the right to required damaged parts to be returned to us upon our request. For MESTYL furniture standards, scars, brands, grain variations, wrinkles, color variations, etc. will be considered as normal characteristics and not interpreted as defects. We cannot guarantee that the leather will not be scratched or scuffed, as all leather furniture could get imperfections with the use.

If you have any questions concerning this warranty, please contact the MESTYL Customer Service department by sending an email to Mestyl@aliyun.com . Be prepared to provide your name, address, daytime phone number, the model and purchase order number of the product, date of the purchase, and the store where it was ordered. All of these information provided by you, will help us to track your order easily and solve your problem in the shortest time.

This warranty gives you specific rights, and you still possess other rights, which vary in terms of each case.

MAKE YOUR HOME STYLE

E-mail: Mestyl@aliyun.com



REV.1

MESTYL