











Assembly Instructions

Caution : You must read this before you proceed

Care & Maintenance

- ⊘  ● Not for commercial use. For residential use only.
- ✓  ● Furniture may scratch floors. We recommend using furniture pads to protect your floors.
- ⊘  ● Do not put hot items directly on furniture surface.
- ⊘  ● Do not clean furniture with harsh cleansers or polish.
- ⊘  ● Do not place furniture under direct sunlight.
- ⊘  ● Do not place furniture near heating or cooling vents.
- ⊘  ● Do not write on furniture without a padded barrier to protect the surface.
- ⊘  ● Do not place furniture outside . For indoor use only.
- ⊘  ● Stains may be removed with mild soap solution and damp cloth.
- ⊘  ● Children should not climb or jump on the furniture.





- Dust and pick-up spills using a clean, non-colored, lint-free cloth.

Please look in carton for hardware packs and legs.
Sets often ship in multiple boxes and may arrive a day or two apart.

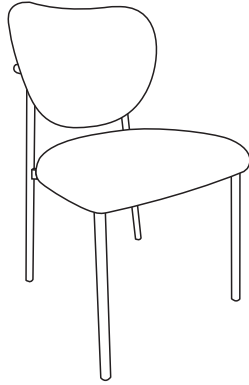

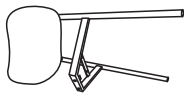

Dining Chair

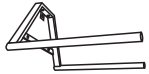

Parts List

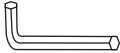
Label	Picture	Description	QTY
A		Back with Leg	1
B		Seat Cushion	1
C		Front Leg	1

Hardware

Label	Picture	Description	QTY
①		Spare Leveller	1
②		Allen Wrench (5mm)	1
③		Bolt (M6x30mm)	3
④		Bolt (M6x25mm)	5
⑤		Bolt (M6x18mm)	3
⑥		Washer (6x18x1.5mm)	9

Assembly Preparation

Before Beginning Assembly :

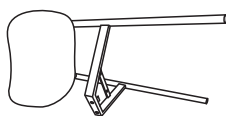

A



B

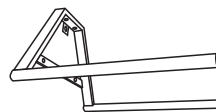

C



① x1



② x1



③ x3



④ x5



⑤ x3



⑥ x9



- Read instructions, cover to cover-



- Have 2 adults on hand for assembly-



- Do not assemble on flooring or carpet-



- Assemble on a clean non-marring surface (packing foam)-



- Save all packaging until finished-

Assembly Steps

Overview

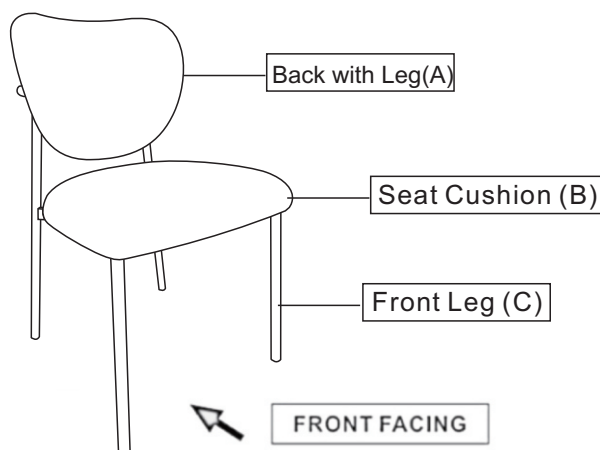

This Dining Chair has multiple parts and may require up to some 30 minutes to assemble. To give you an overview of the Dining Chair parts, the above picture is to help you put the various parts into perspective. Please read through the instructions below to familiarise yourself with the parts and steps before assembly.

Step1

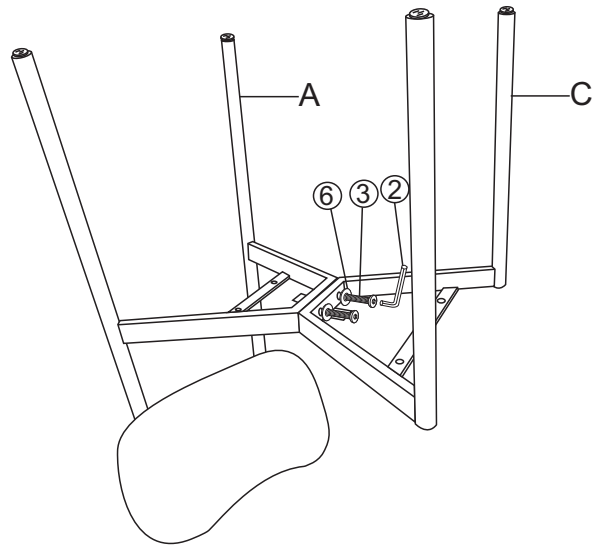
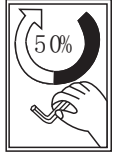

Attach the Leg (C) to Leg (A) using the Washer(⑥),Bolts (③) with Allen Wrench (②) as pictured above.
Do not fully tighten the Bolts.

Step2

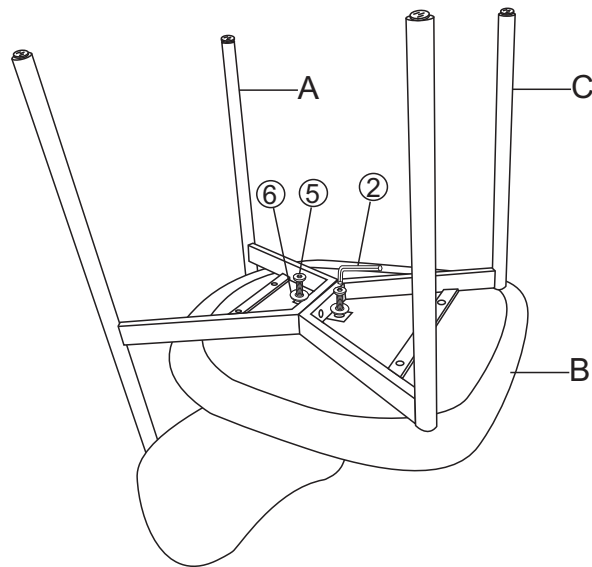
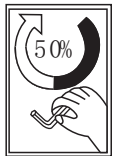

Attach the Seat Cushion(B) to Back with Leg(A) and Leg(C) using the washer (⑥),Bolts (⑤) with Allen Wrench (②)as pictured above.
Do not fully tighten the Bolts.

Step3

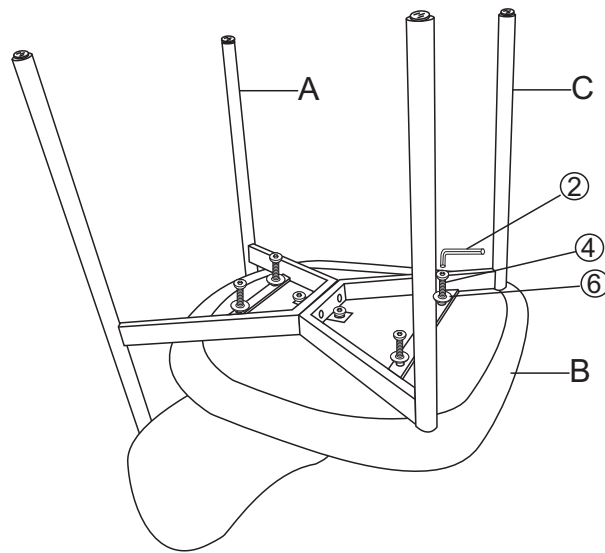

Attach the Leg (C) and Back with Leg (A) to the Seat Cushion(B) using the Washer (⑥),Bolts (④) with Allen Wrench (②) as pictured above.

Fully tighten the Bolts.

CAUTION : When tightening these screws, tighten sequentially.

DO NOT tighten any screw fully and then towards the next one.

This would cause the frame to warp.

If there is still wobbles, loosen the screws and execute this same process.

WARNING!! IF IT IS NOT STABLE , IT COULD LEAD TO DAMAGING THE PRODUCT.

Step4

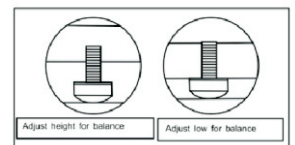
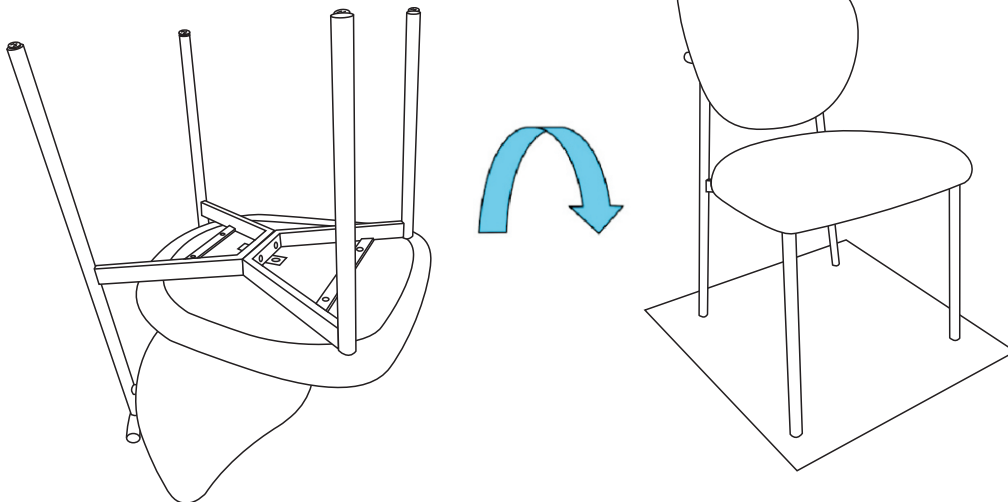

After checking the chair,If no problem,pls tighten all the Bolts.

Stand the Chair up .

Place the chair on a **LEVEL SURFACE** to check for wobbles .

Adjust the levelers to ensure chair stability .

Step5

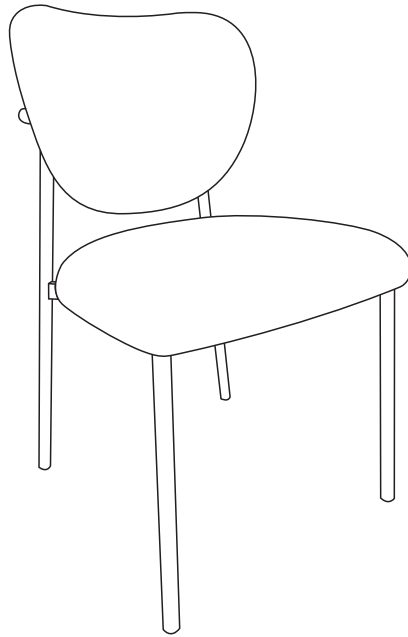

Your Chair is ready for use .
This chair can only be used on a flat, level surface.