

ASSEMBLY INSTRUCTIONS

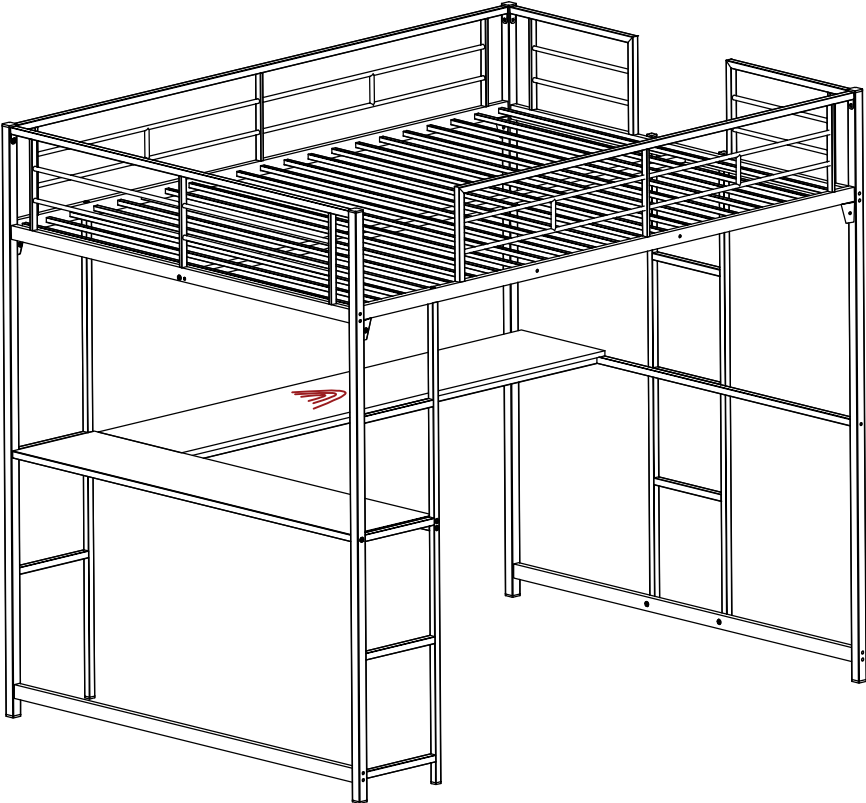

TOOLS REQUIRED

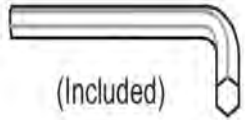

(Included)

Allen Wrench



2- People

ASSEMBLY RATING



EASY —————> DIFICULT

The Assembly Rating is a 5-point system showing the level of effort needed to assemble a specific product.



CHECK BEFORE STARTING

Are you missing anything?

Double-check all parts, hardware and accessories listed are all accounted for.

Check out our Quick Tips!

We recommend reviewing the pre-assembly handouts. Even experts need a refresher now and then!

Should we send any replacements?

Are there any irregularities or flaws in the parts? We can send replacements!

Prep Time!

Please review the assembly instructions and all diagrams prior to assembling.

PRE ASSEMBLY INTRODUCTION

We understand building ready-to-assemble furniture can be a challenging experience for some. To help avoid confusion, we have provided some helpful tips that may speed up the process.

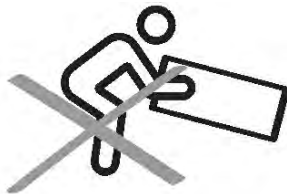

Teamwork

ALWAYS have at least two people to help with transporting and assembling the product to avoid potential injury and/or damage.

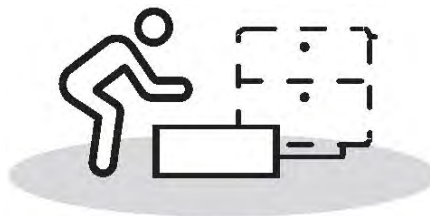

Suitable Location

Assembling near the area of the intended location is highly recommended.



Sufficient Space

Make sure you have enough space to move around during the assembly.



Avoid Scratches

Use cardboard, blankets or a carpeted area while assembling furniture to prevent scratches and damages.

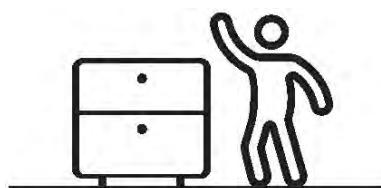
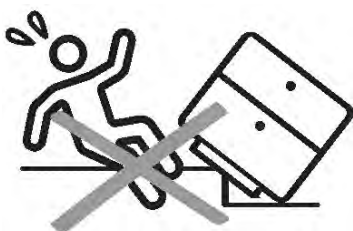

Flat Surface

Make sure the furniture rests on a flat and level surface with each leg evenly touching the floor.

ASSEMBLY AND CARE ADVICE



FAILURE TO FOLLOW THE GUIDELINES BELOW MAY RESULT IN INJURY AND/OR PROPERTY DAMAGE.



Position each part correctly and insert screws or bolts into their respective holes



Turn clockwise to tighten and only tighten when step is completed or when instructed to do so.



Use the appropriate hand tools or power tools for assembly. Select steps, such as tightening screws and/or bolts, may require hand tools to avoid causing damage during assembly.



Save the instructions and store any supplied tools for later maintenance.



After two weeks, check and tighten any loose hardware and repeat again every six months thereafter.

IT IS USER'S RESPONSIBILITY TO MAINTAIN THE FURNITURE. THE HARDWARE MAY LOOSEN OVER TIME AND MAY CAUSE THE FURNITURE TO BE WOBBLY AND UNABLE TO SUPPORT ITS INTENDED WEIGHT CAPACITY. THIS MAY LEAD TO COLLAPSE AND MAY CAUSE SERIOUS INJURY.

METAL FULL LOFT BED



- Please keep instructions for future reference.
- Check the quantity and irregularity of parts and hardware before you start.

PARTS LIST FM-BK905-1

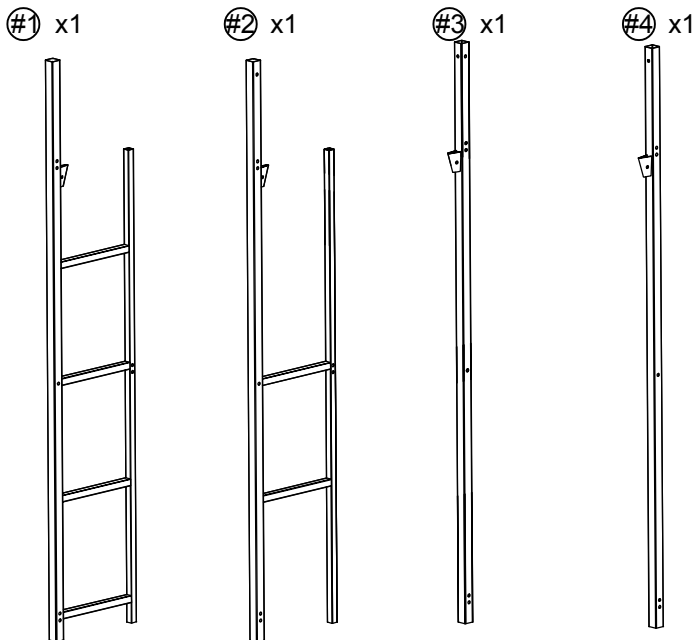

Left Front Post Left Rear Post Right Rear Post Right Front Post

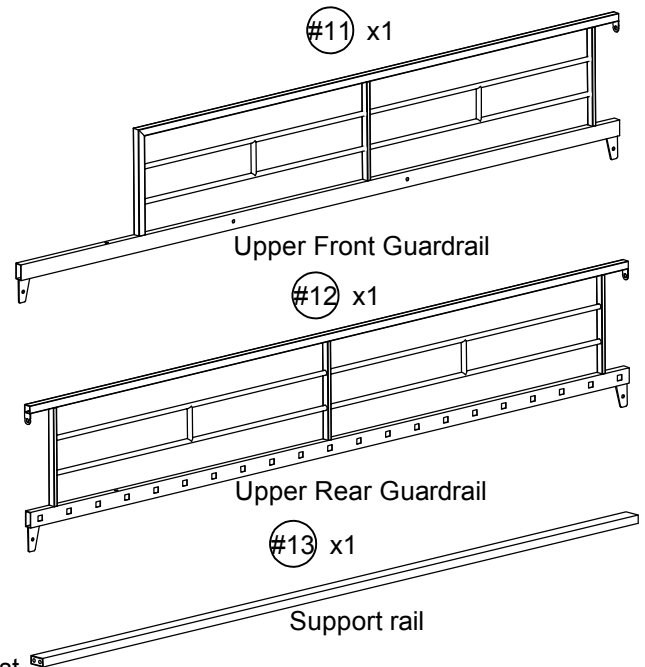

Upper Front Guardrail

Upper Rear Guardrail

Support rail

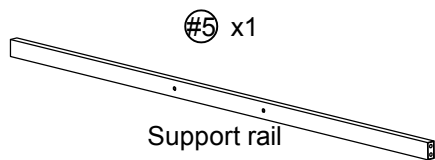

Support rail

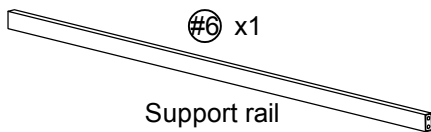

Support rail

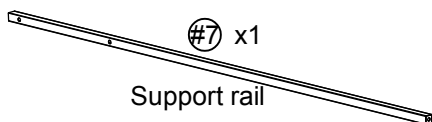

Support rail

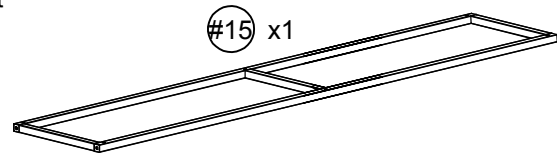

Desk top

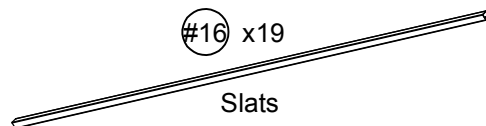

Slats

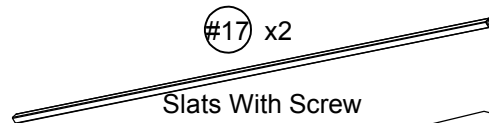

Slats With Screw

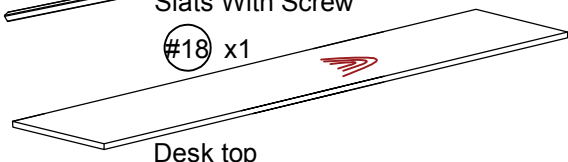

Desk top

METAL FULL LOFT BED

FM-BK905



- Please keep instructions for future reference.
- Check the quantity and irregularity of parts and hardware before you start.

PARTS LIST FM-BK905-2

#8 x1

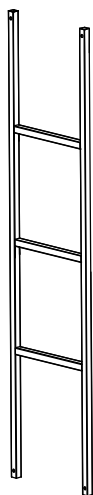

Ladder

#9 x1

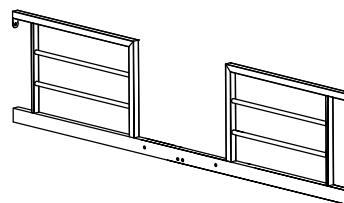

Upper Right Head Panel

#10 x1

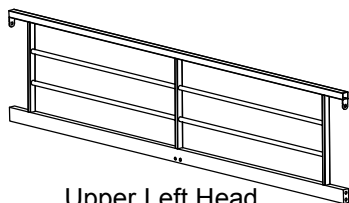

Upper Left Head Panel

#14 x1

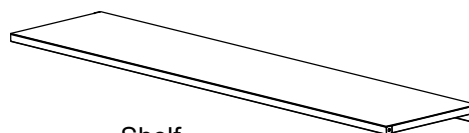

Shelf

HARDWARE FM-BK905-1

#A x2

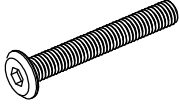

Bolts 1/4" x 60

#B x20

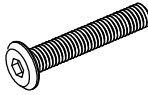

Bolts 1/4" x 50

#C x16

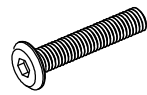

Bolts 1/4" x 40

#D x6

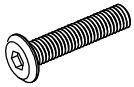

Bolts 1/4" x 30

#E x4

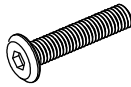

Bolts 1/4" x 20

#F x11



Bolts 1/4" x 15

#G x4



Hex nut 1/4" x 5

#H x8

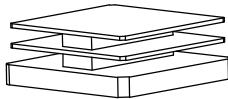

Cover 30 x 30

#I x6

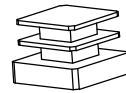

Cover 20 x 20

#K x1

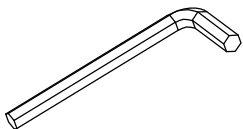

Allen wrench M4 x 59

#L x1

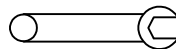

Wrench 1/4"

#M x1

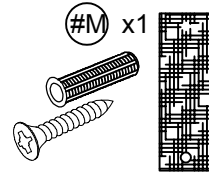

Connect Wall 1/4" x 40

ASSEMBLY INSTRUCTIONS

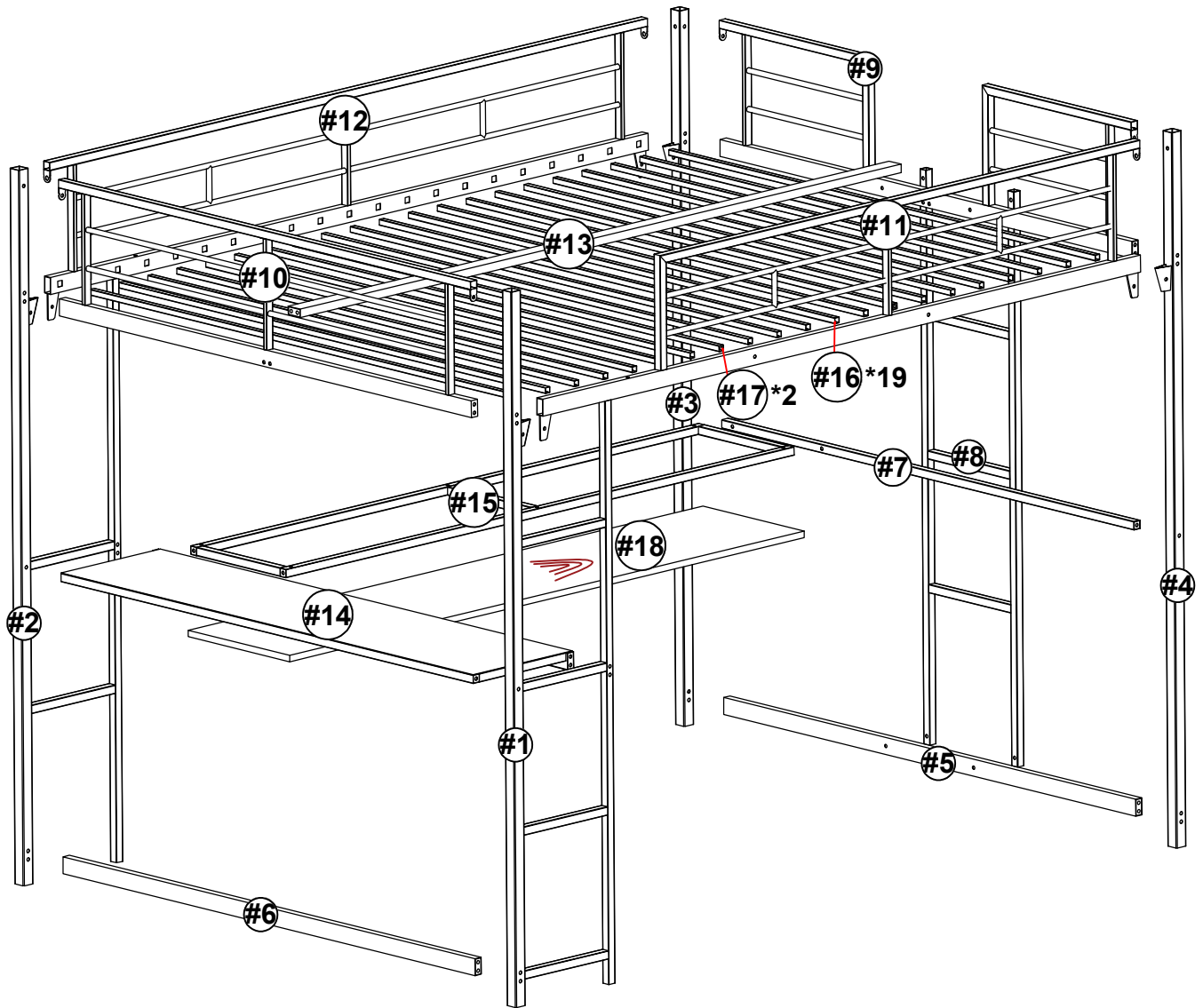

Exploded View



ASSEMBLY INSTRUCTIONS

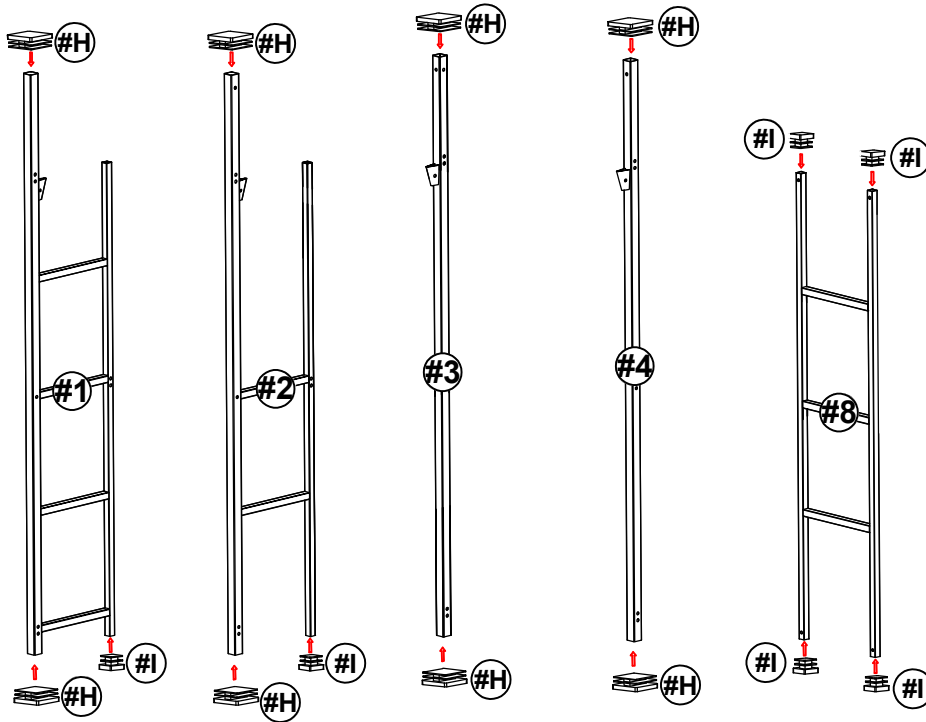

STEP 1 :

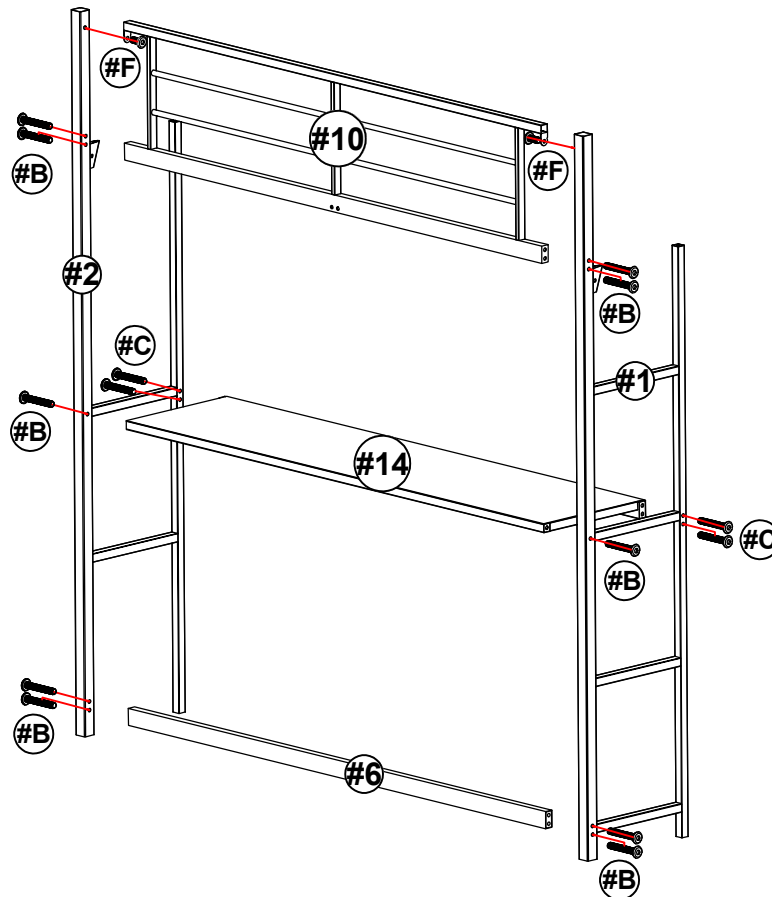

#H	8PCS
 30 x 30	
#I	6PCS
 20 x 20	

STEP 2 :

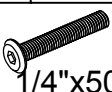
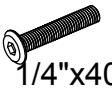



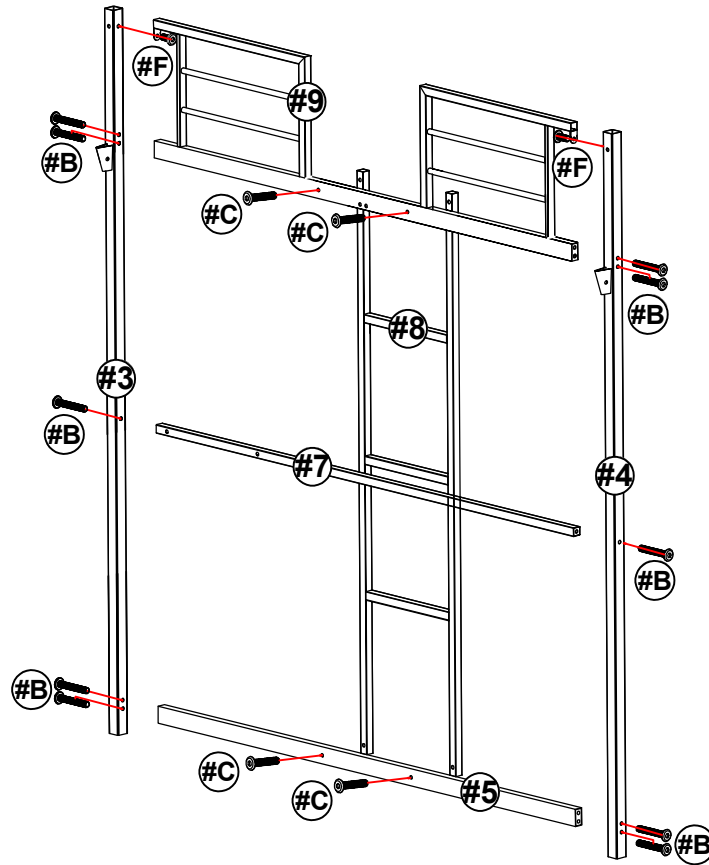

#B	10PCS
 1/4"x50	
#C	4PCS
 1/4"x40	
#F	2PCS
 1/4"x15	
#K	1PC
 M4	

ASSEMBLY INSTRUCTIONS

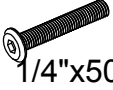

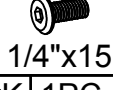
STEP 3 :

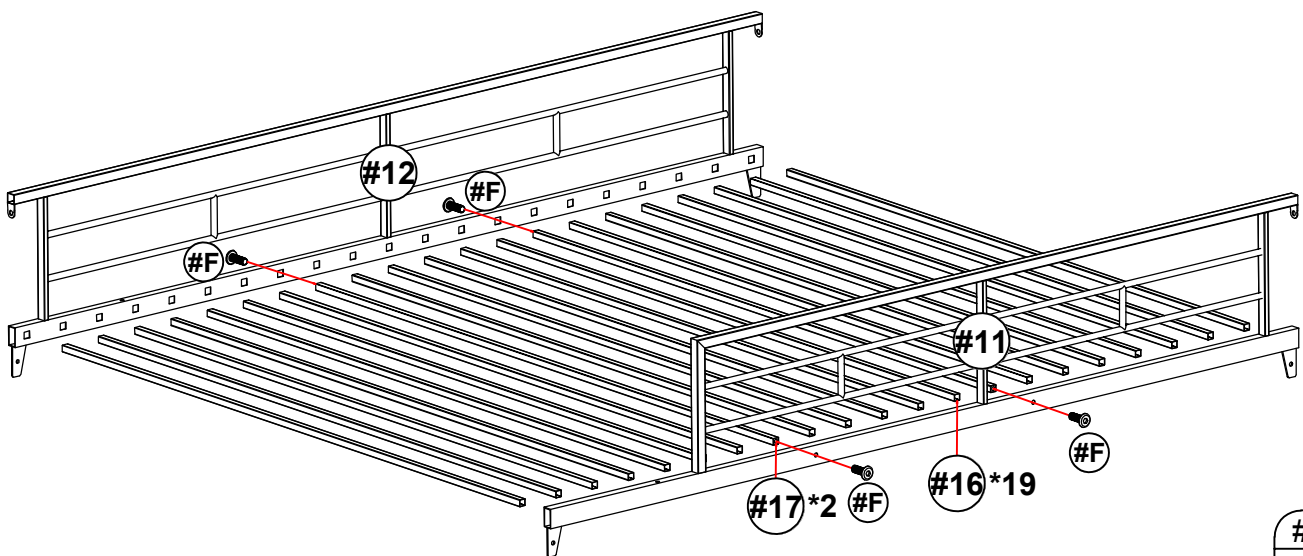

#B	10PCS
	1/4"x50
#C	4PCS
	1/4"x40
#F	2PCS
	1/4"x15
#K	1PC
	M4

STEP 4 :

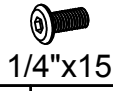





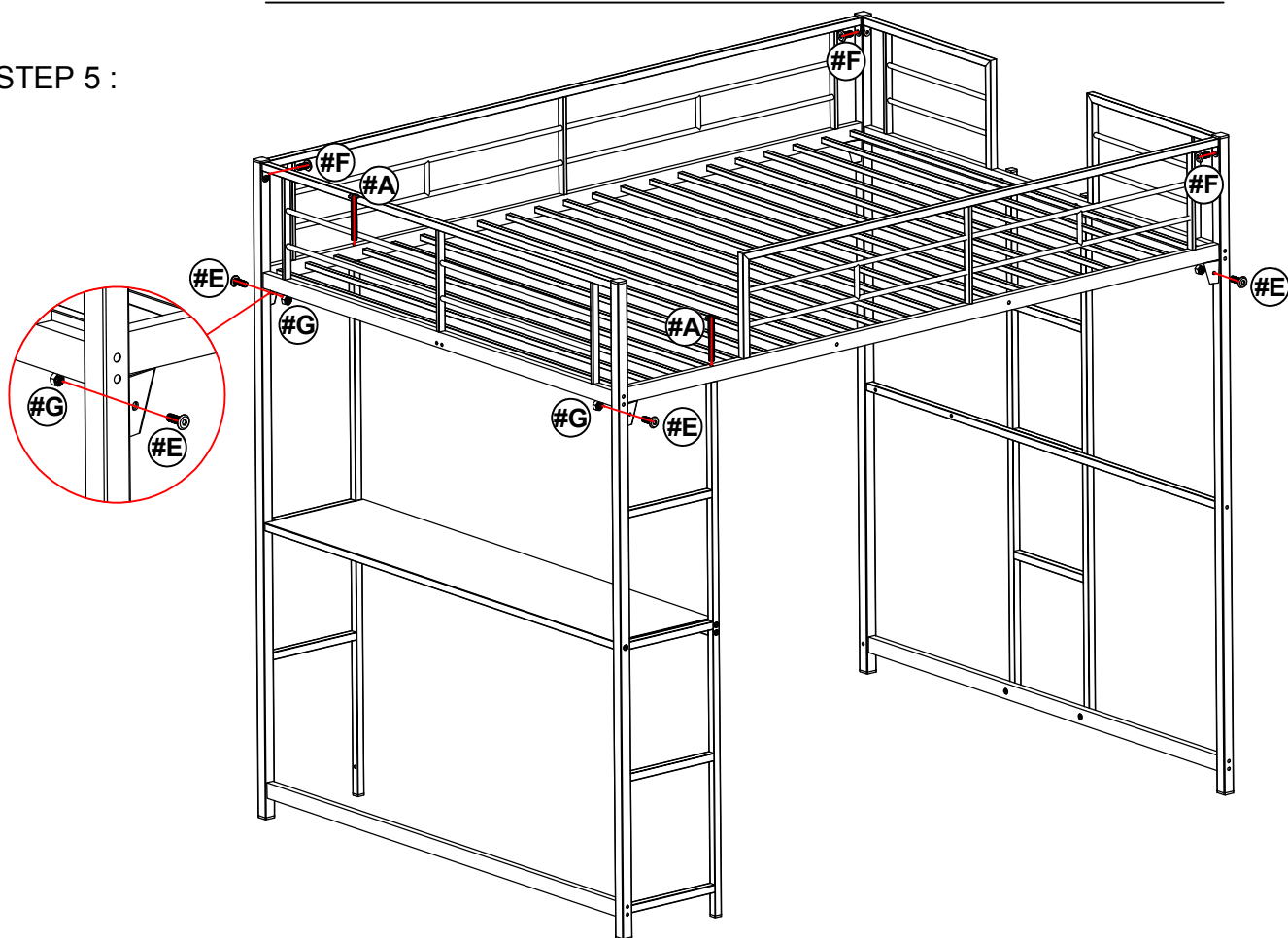

#F	4PCS
	1/4"x15
#K	1PC
	M4

ASSEMBLY INSTRUCTIONS

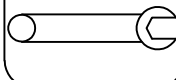

STEP 5 :

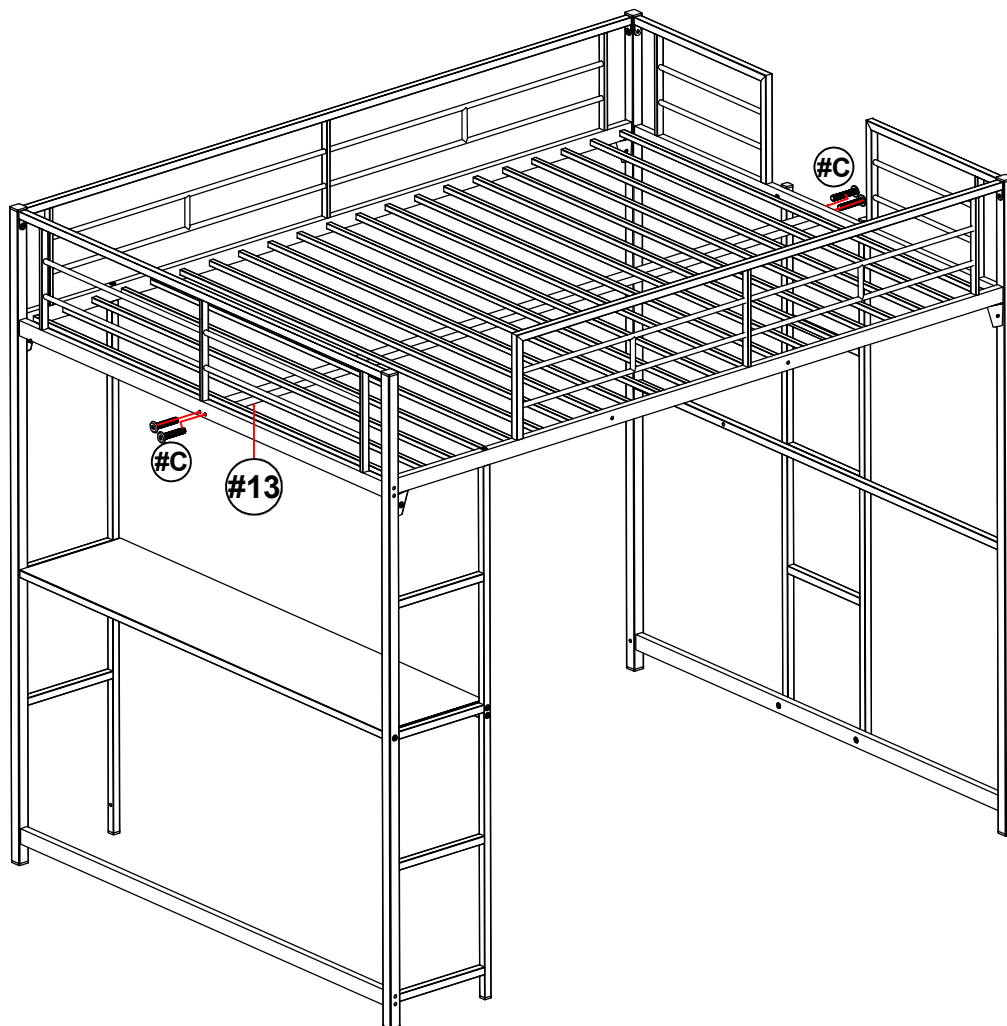

- #A 2PCS

- #E 4PCS

- #F 3PCS

- #G 4PCS

- #L 1PC

- #K 1PC

STEP 6 :





- #C 4PCS

- #K 1PC

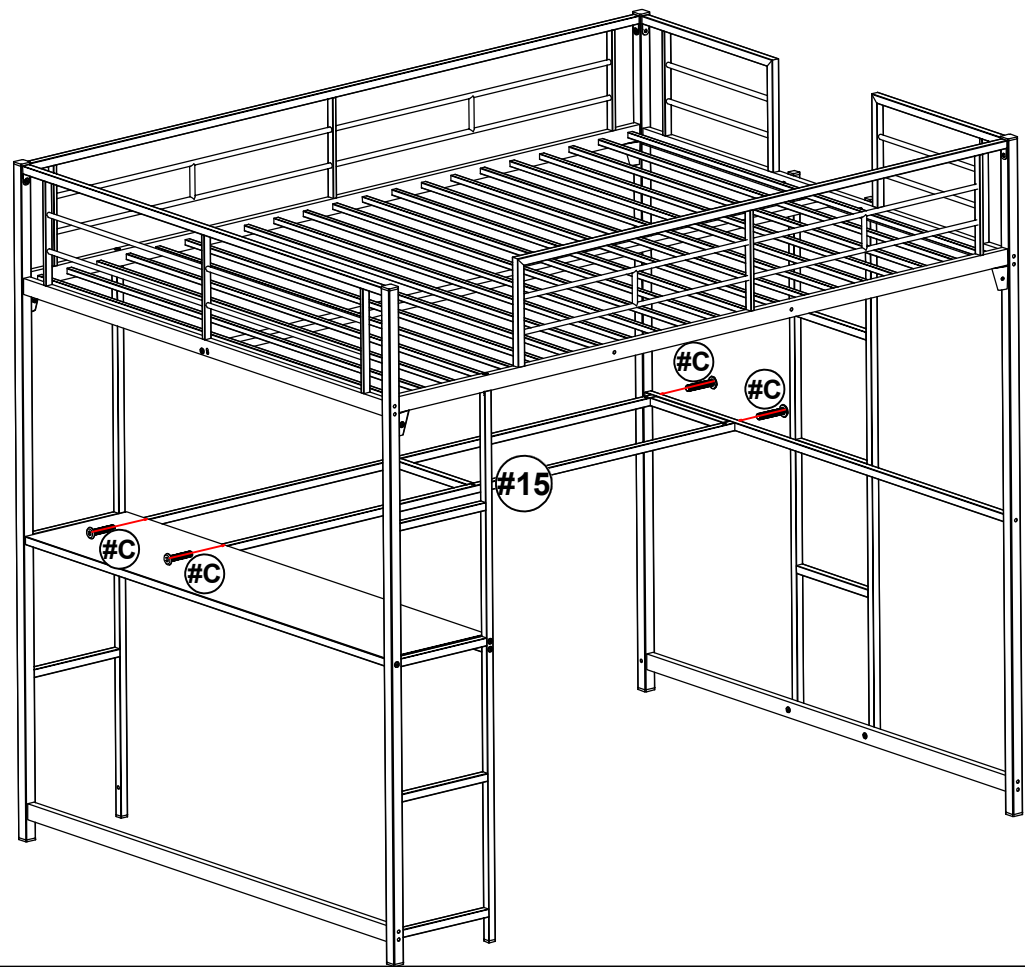
ASSEMBLY INSTRUCTIONS

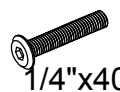

STEP 7 :

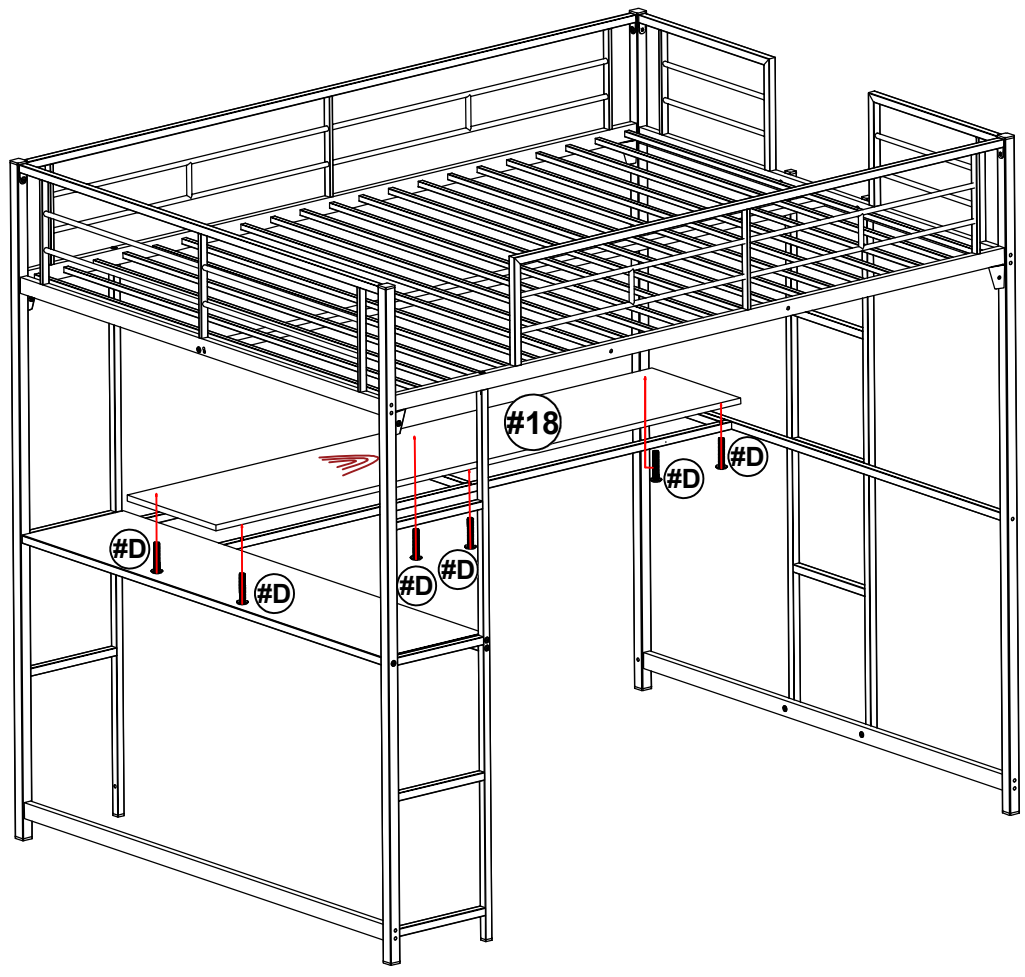

#C	4PCS
	1/4"x40
#K	1PC
	M4

STEP 8 :

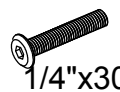

#D	6PCS
	1/4"x30
#K	1PC
	M4

ASSEMBLY INSTRUCTIONS

STEP 9 :

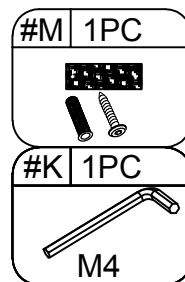
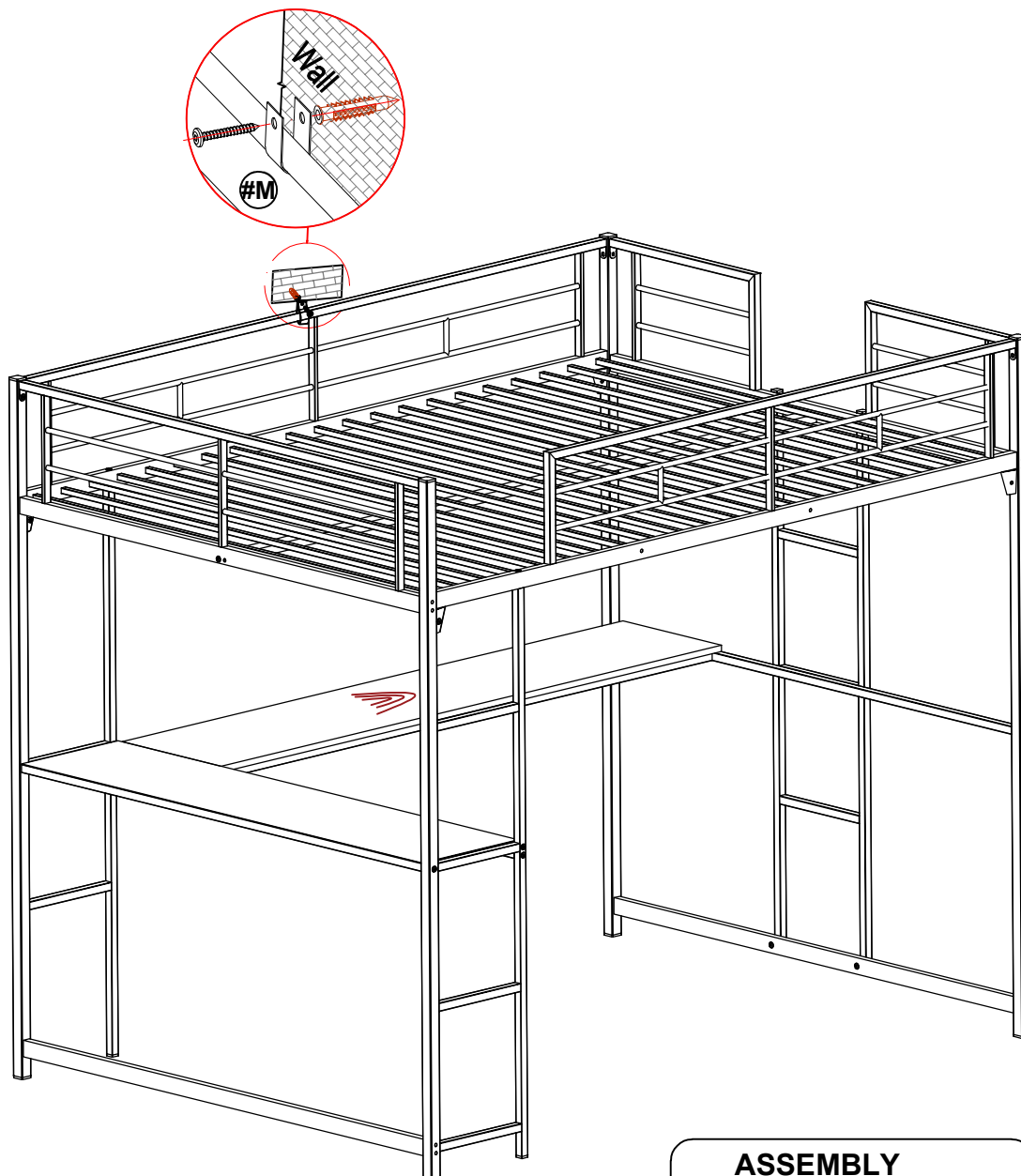

ASSEMBLY COMPLETED



Please ensure the furniture resets on an even and flat surface. If the product wobbles or feels loose, double-check all bolts and/or screws are properly tightened and secured.



Keep this handy!

Please retain this instruction manual and any order-related information for future reference.



Lift, don't drag!

To avoid damage to product please always LIFT the product when transporting or adjusting the placement.

This product is intended for RESIDENTIAL USE ONLY and not for commercial use.

Safety Warnings for Loft Beds

1. Read and follow the information on the WARNING labels shown on the end structure of the upper bunk and on the carton.
2. Do not remove warning labels from the bed.
3. Keep these instructions for future use.
4. IMPORTANT: The proper sizes for the UPPER FULL-SIZE mattress should be 74"-75" long and 53"-54" wide with no more than 6" thickness.
5. Surface of mattress must be at least 5 inches (127 mm) BELOW the upper edge of the guardrails.
6. The MAXIMUM weight capacity for the upper bunk is not to exceed 150 lbs.
7. Do not allow children under 6 years of age to use the upper bunk.
8. Periodically check and ensure that the guardrails, ladder, handle and other components are in their proper position, free from damage, and that all connectors are tightened and secured.
9. DO NOT allow horseplay, rough playing, or jumping on the beds and do not allow playing or hiding under the beds.
10. Always use the ladder for entering or leaving the upper bunk.
11. Do not use substitute parts. Contact the manufacturer or dealer for replacement parts.
12. Use of a nightlight may provide added safety precaution for a person using the upper bunk.
13. Always use the guardrails on both sides of the upper bunk.
14. If the bunk bed will be placed next to a wall, the guardrail that runs the full length of the bed should be placed against the wall to prevent entrapment between the bed and the wall.
15. The use of water or sleep flotation mattresses is prohibited.
16. No more than one person is allowed on the upper bunk at all times.
17. Always use the recommended size mattresses or mattress supports, or both, to help prevent the likelihood of entrapment or falls.

