

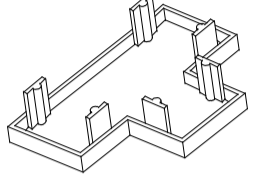
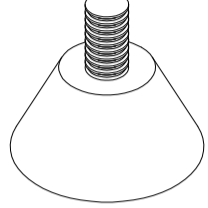
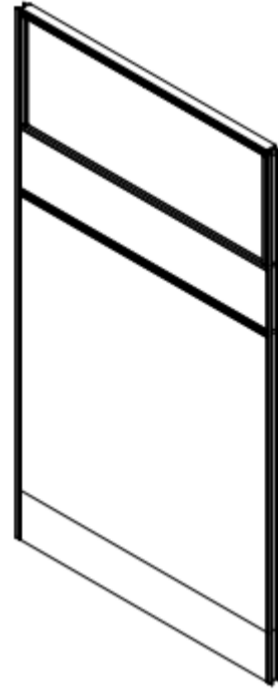
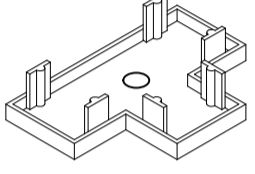
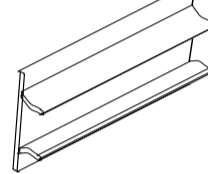
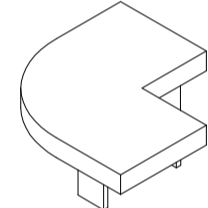
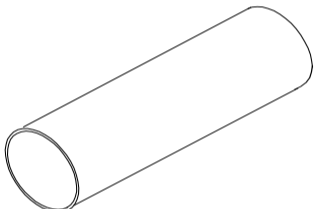
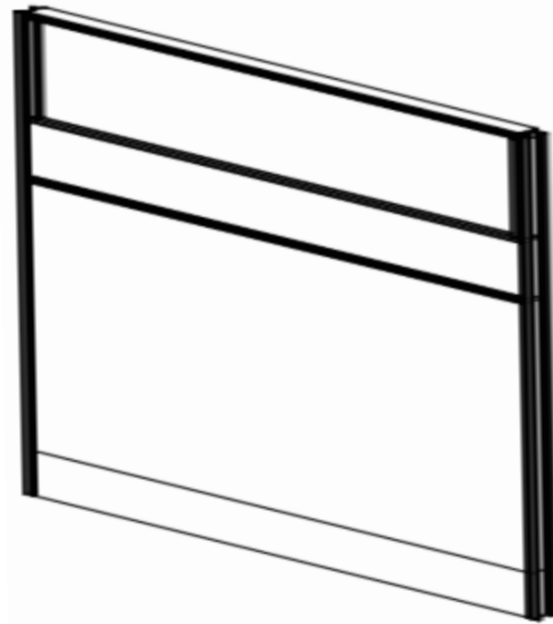
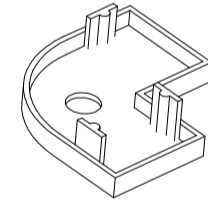
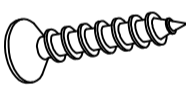
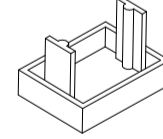
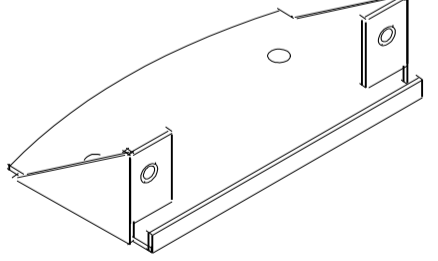

List Of Parts

*It includes two hardware packages. The extra parts in the second package serve as backup parts.

<p>T-shaped interface </p>	<p>Adjustable foot </p>	<p>Privacy panel (small) * 8</p> <p>6 for install 2 spare vs shipping damage</p> 
<p>T-joint </p>	<p>Side banding </p>	
<p>L-shaped interface </p>	<p>Cylindrical tube </p>	<p>Privacy panel (Big) * 2</p> 
<p>Cross foot </p>	<p>Self-tapping yarn </p>	
<p>Side joint </p>	<p>corbel </p>	<p>Desktop* 4</p> 
<p>pleurocrus </p>		

Installation guide

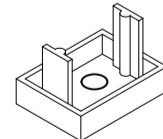
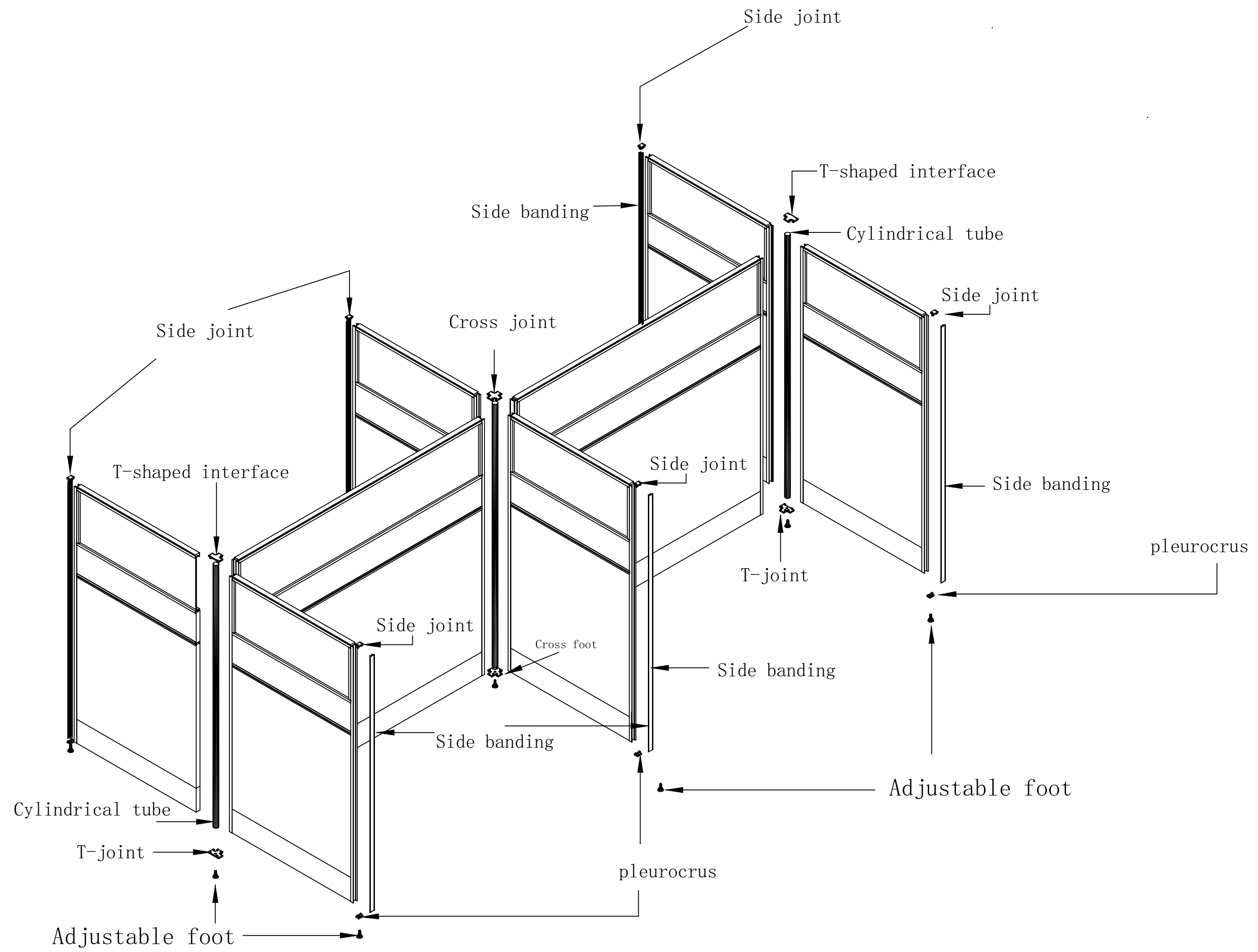

Step 1

Step 2

The bracket arm is adjusted and fixed on the screen plate with self-tapping.

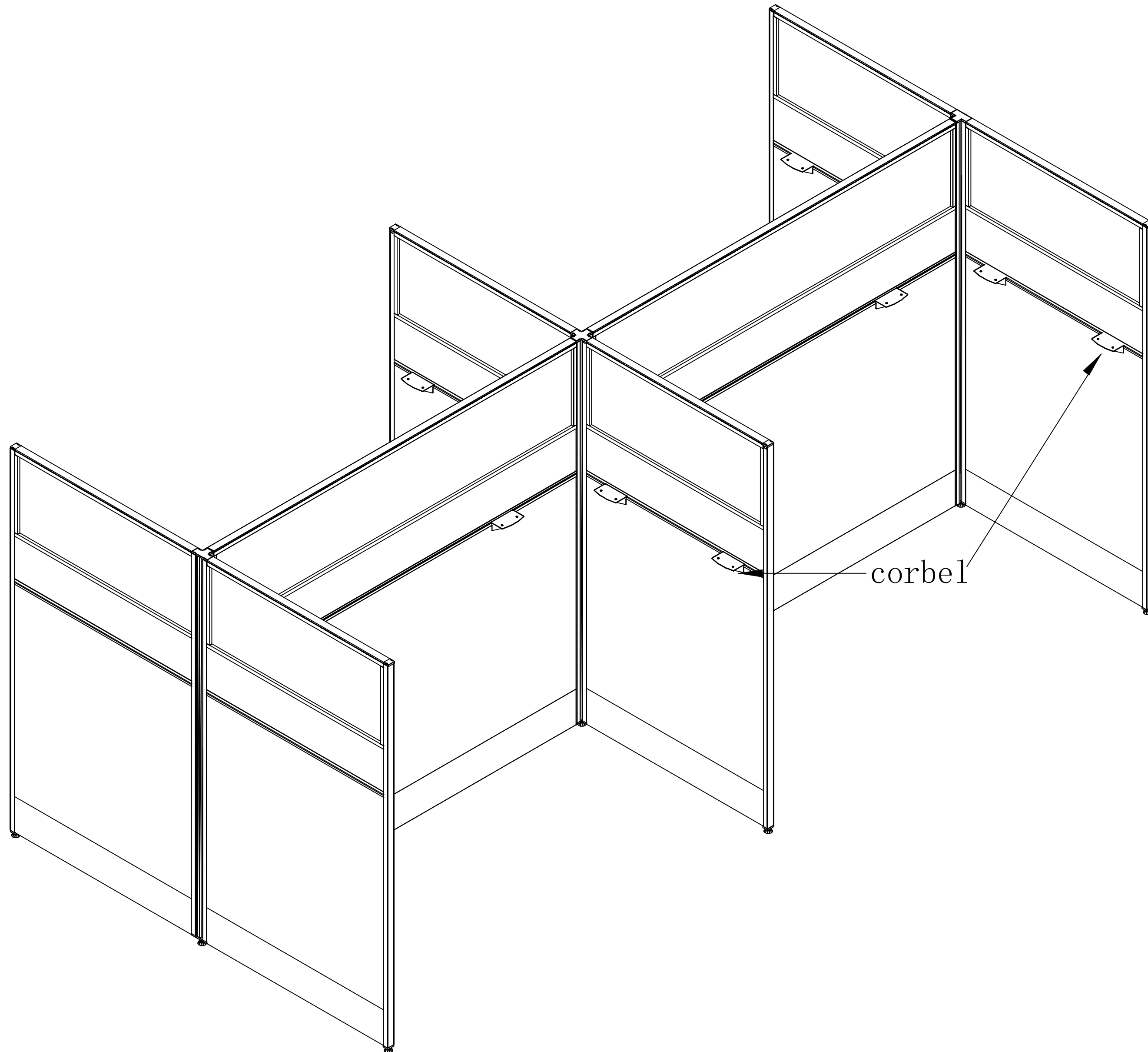

Step 3

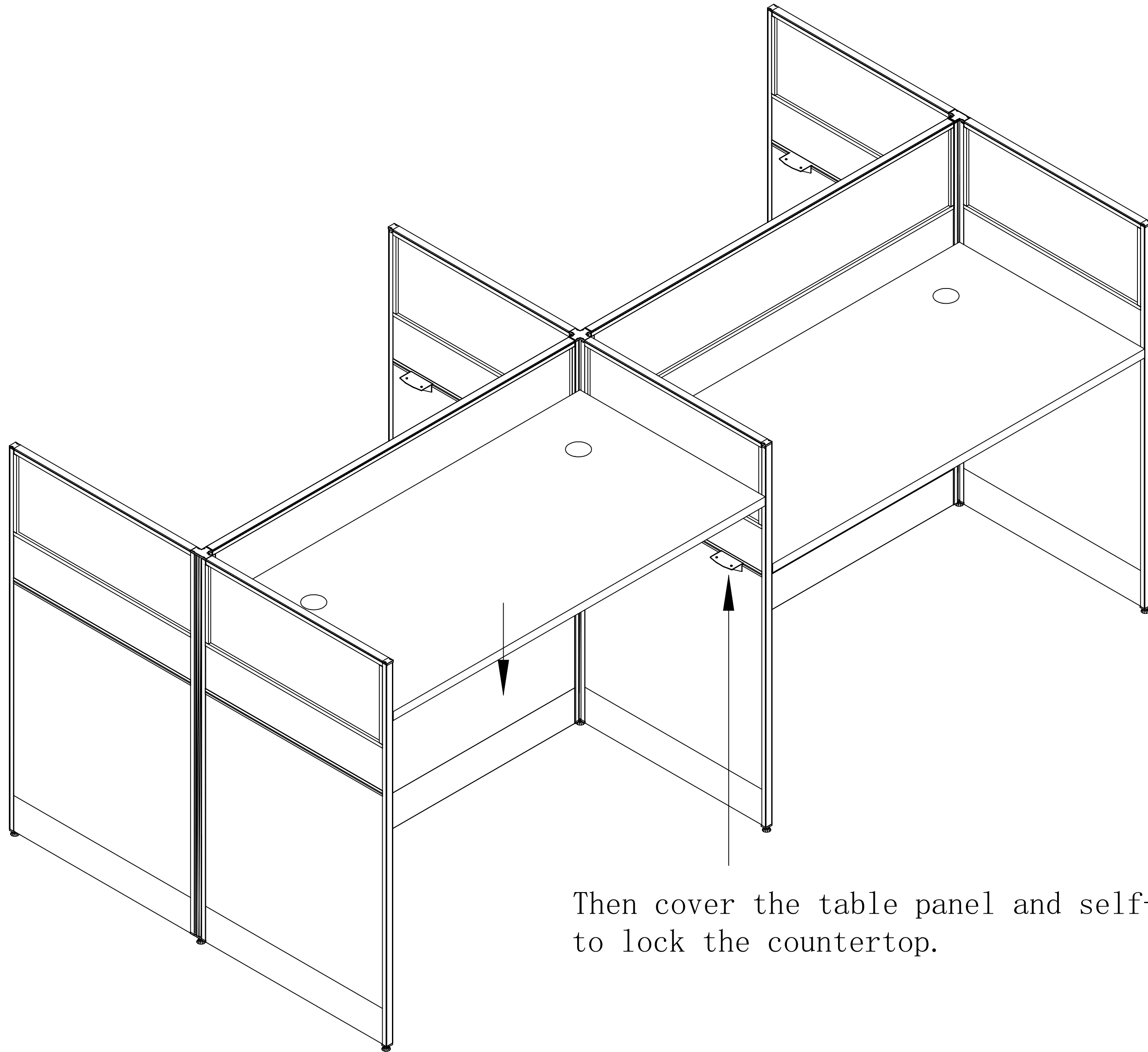

Then cover the table panel and self-tapping screws to lock the countertop.