

Owner Manual

**ATTENTION: DO NOT RETURN THIS PRODUCT!!!
PLEASE READ THE FOLLOWING!!!**

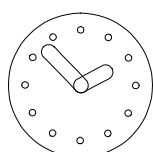

Assembly instruction

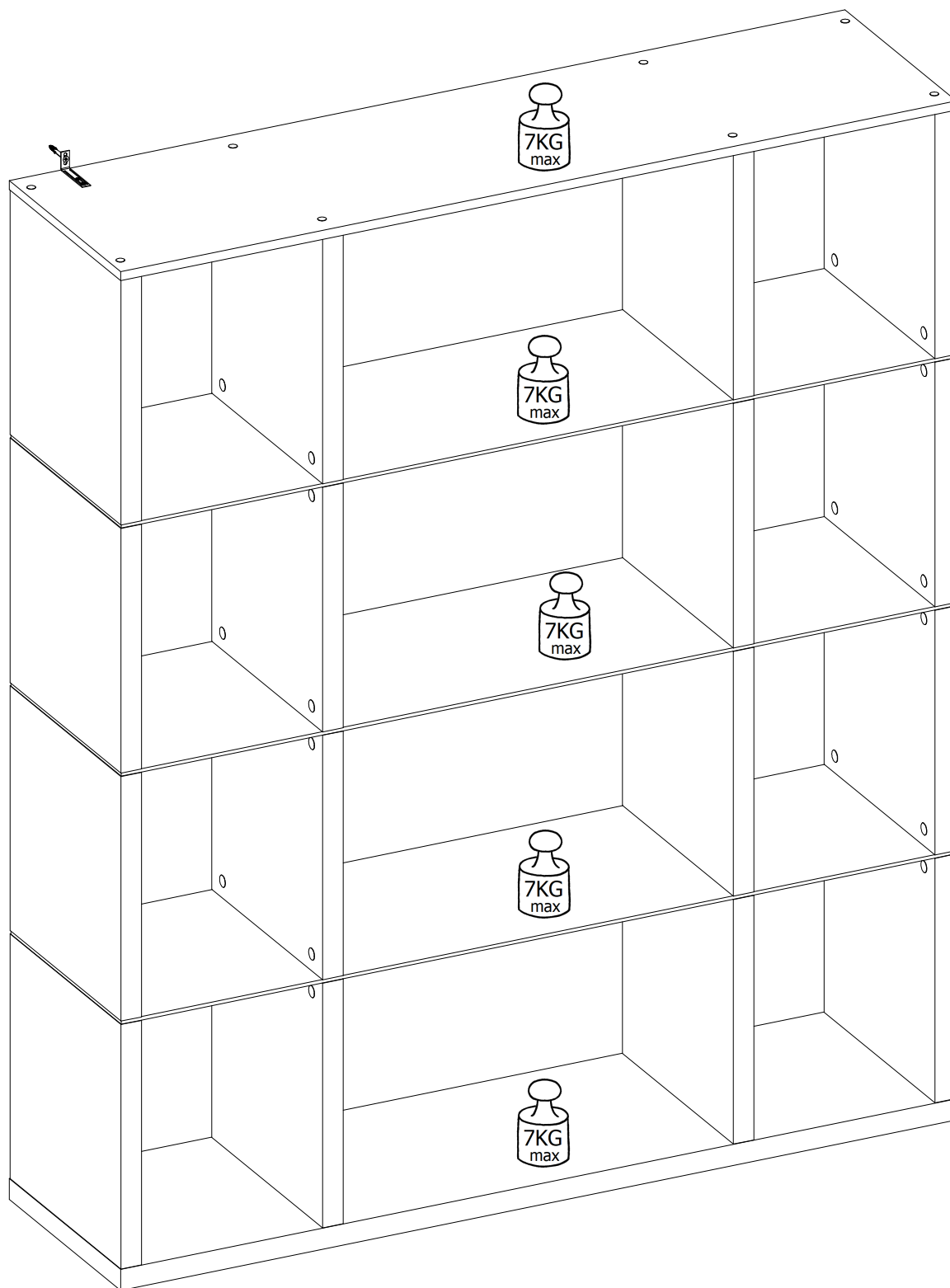

120min

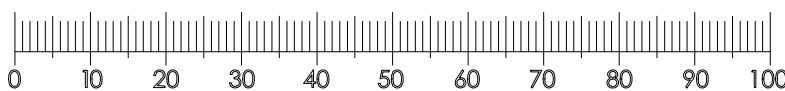
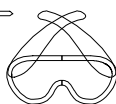
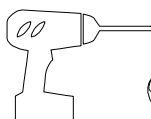
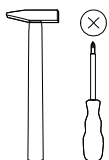
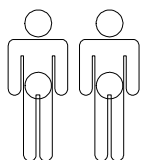
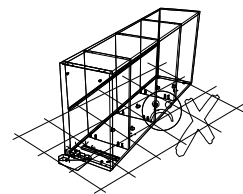
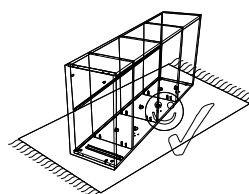
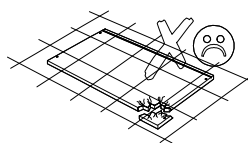
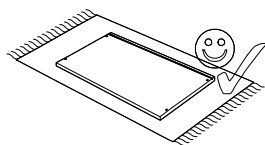

Assembly instruction

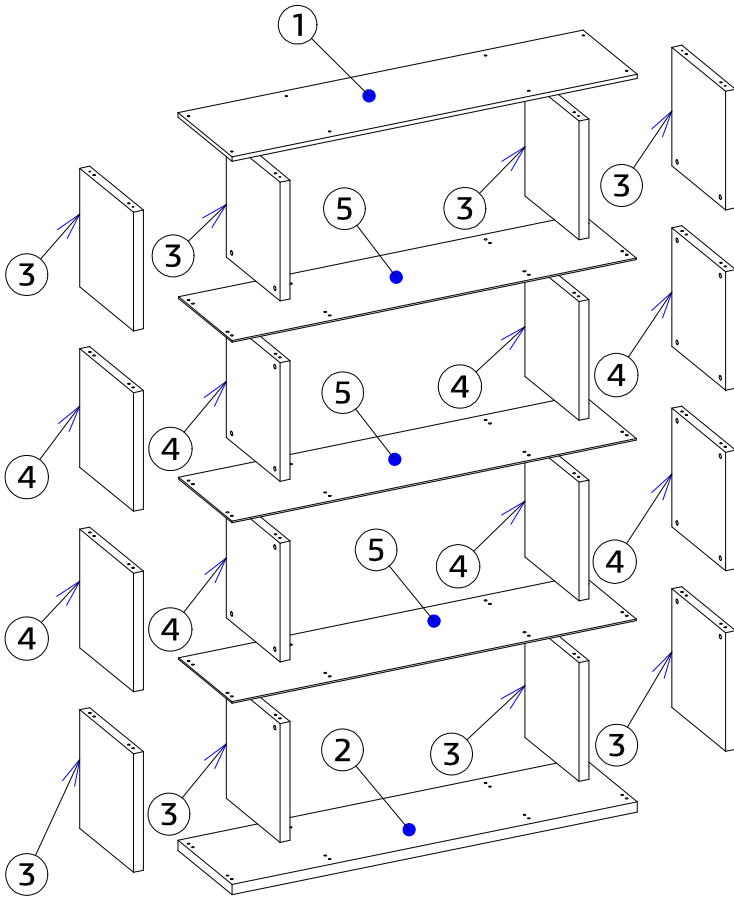

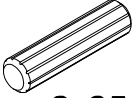
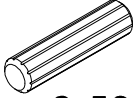
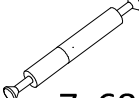
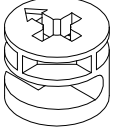
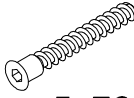

5	58 29/32	15 19/32	3
4	16 15/16	15 21/32	8
3	16 15/16	15 21/32	8
2	59 1/16	15 3/4	1
1	59 1/16	15 3/4	1
INDEX	L(inch)	W(inch)	QTY

Hardware list

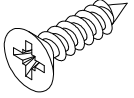
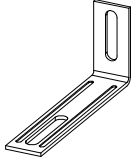
K x16	K2 x24	TP x24	M x48	KN2 x16
				
8x35	8x50	7x68		5x70

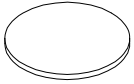
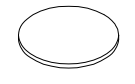
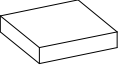
W3 x2	KT1 x1
	
3.5x16	

Z x48	Z2 x16	PF x8
		

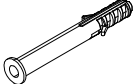
RW x1	RK x1
	

Q x1

STEP 1

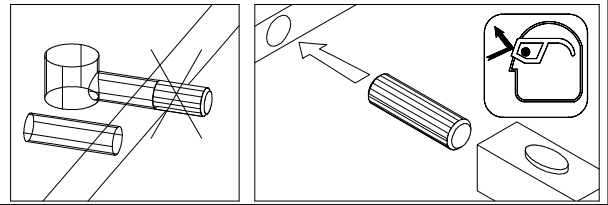
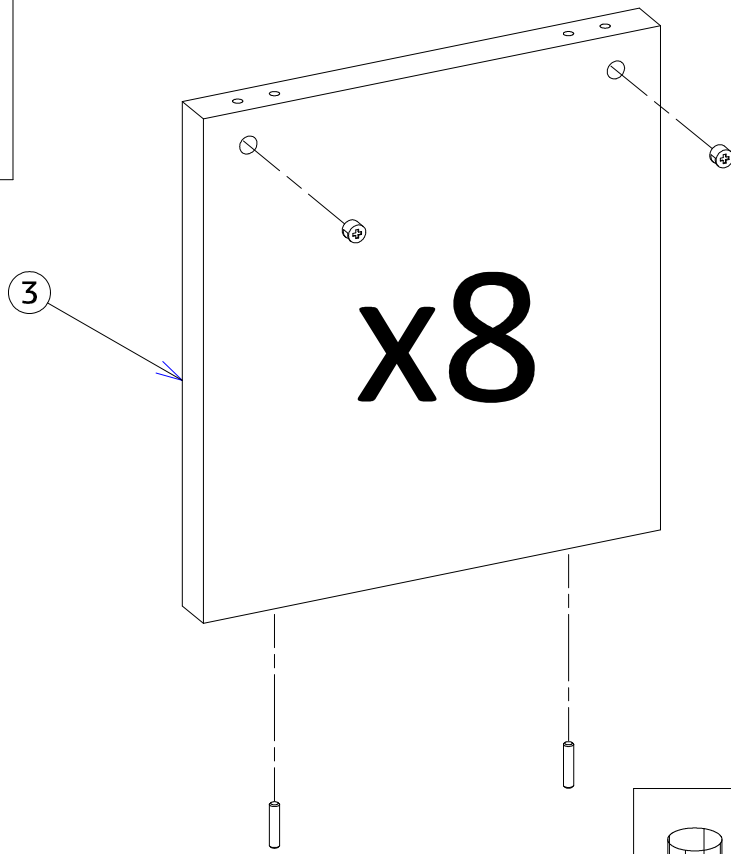
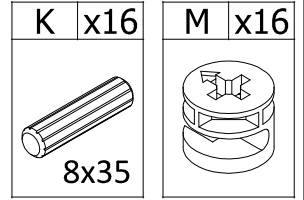
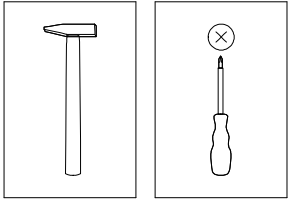

STEP 2

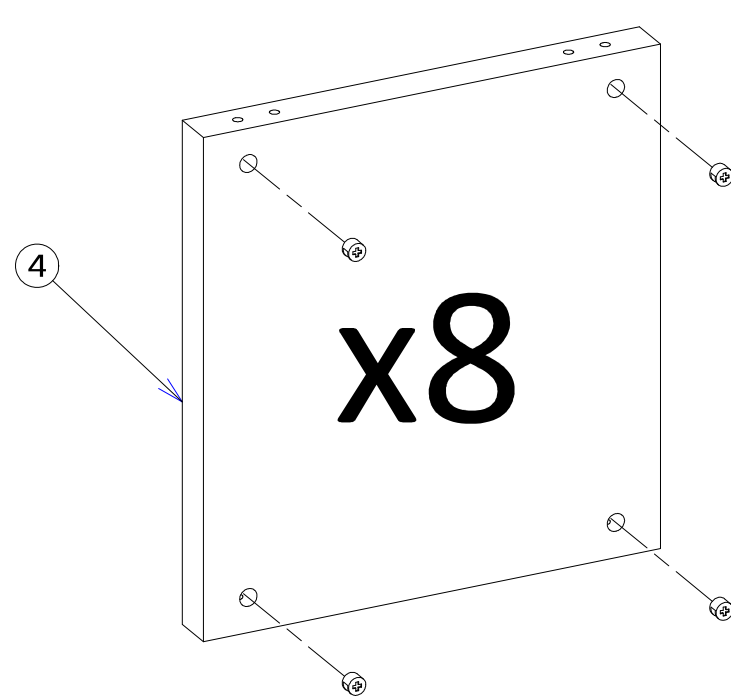
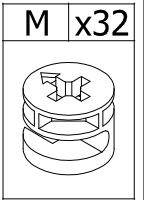
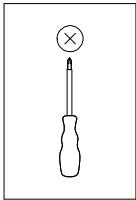

STEP 3

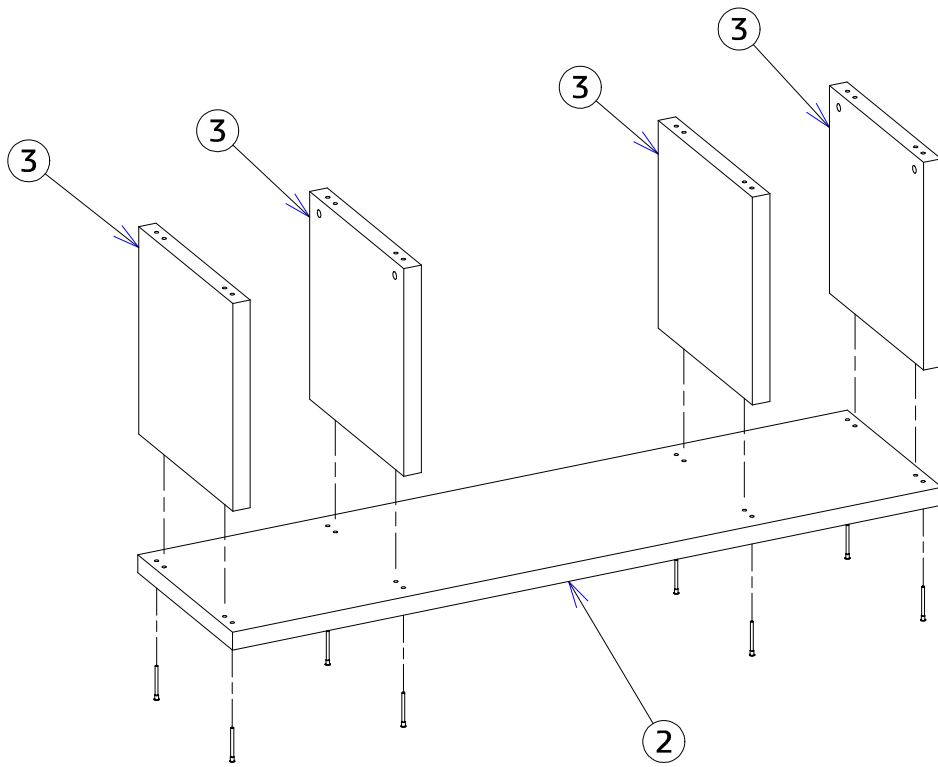
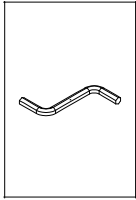

KN2 x8

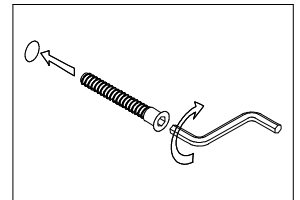

STEP 4

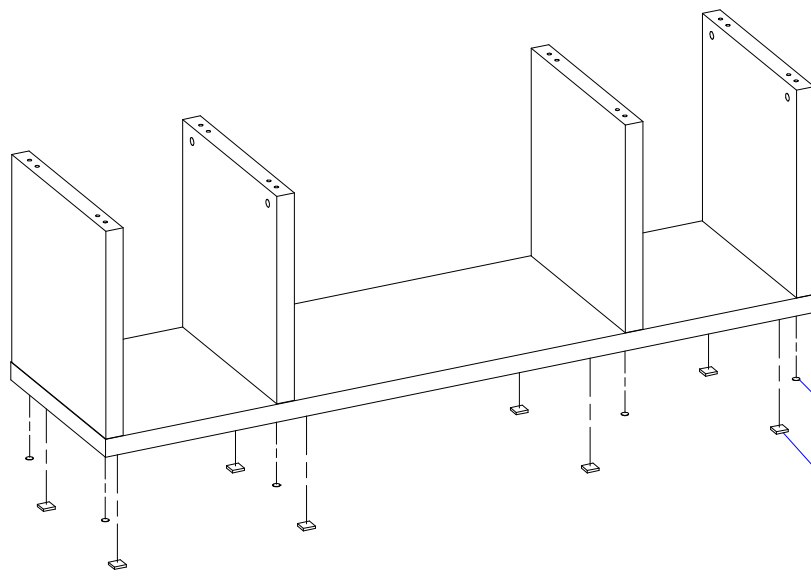
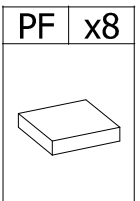
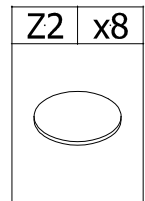

Z2
PF

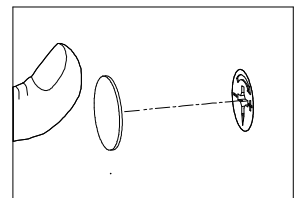
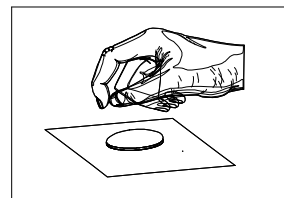

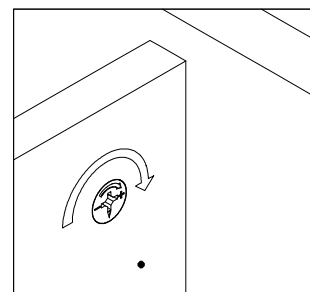
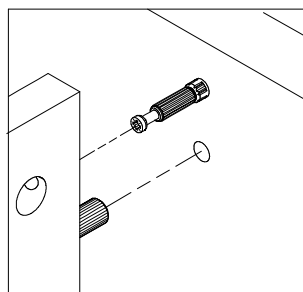
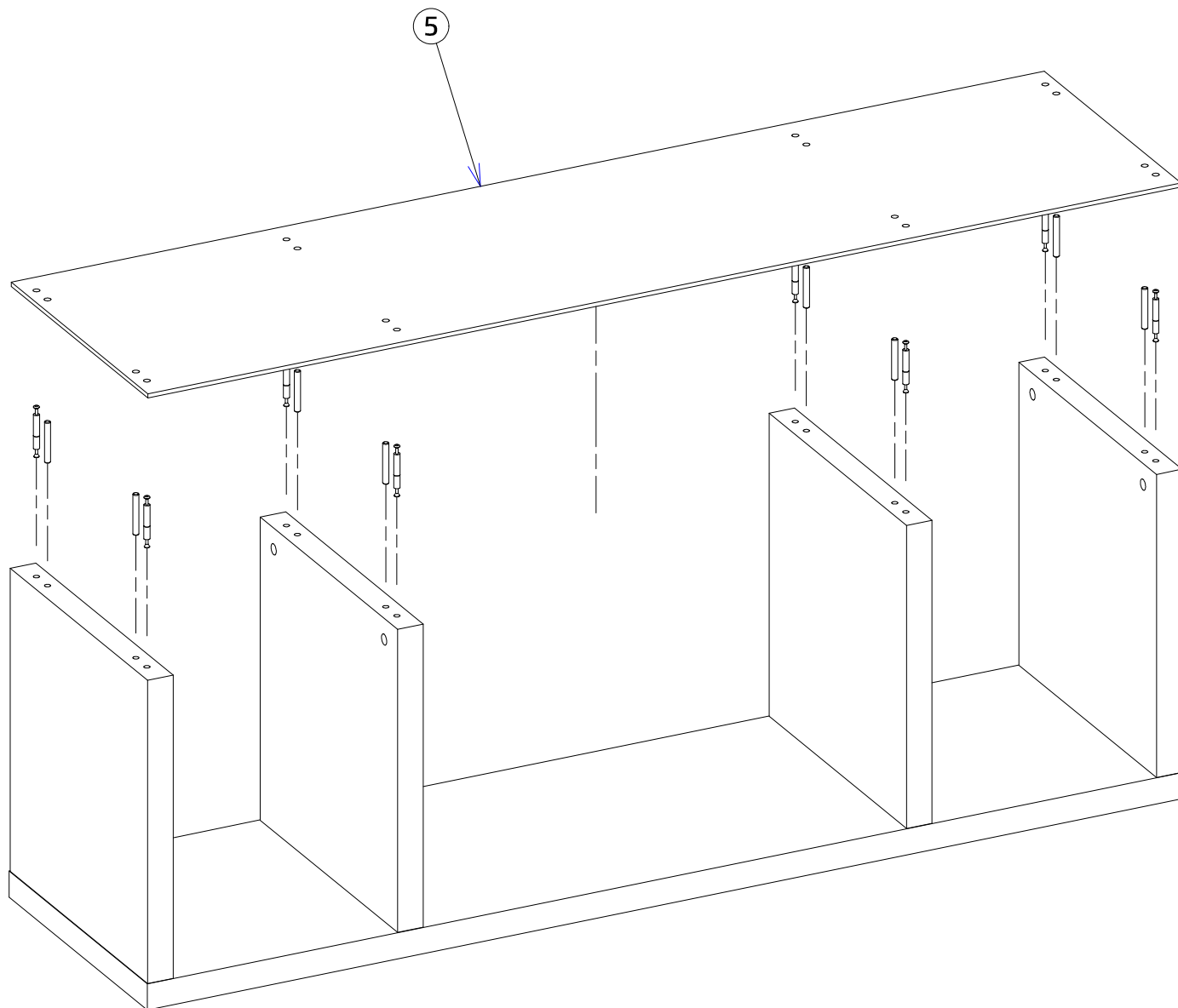
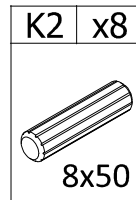
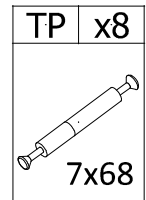
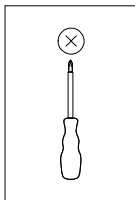

STEP 5

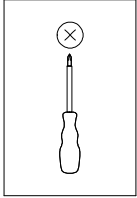

STEP 6



TP x16	K2 x16
 7x68	 8x50

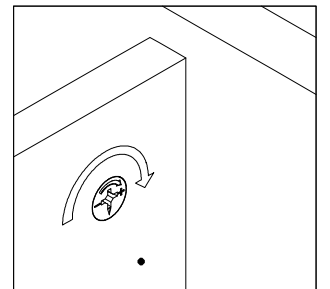
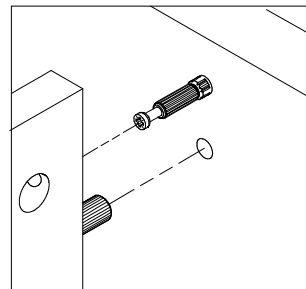
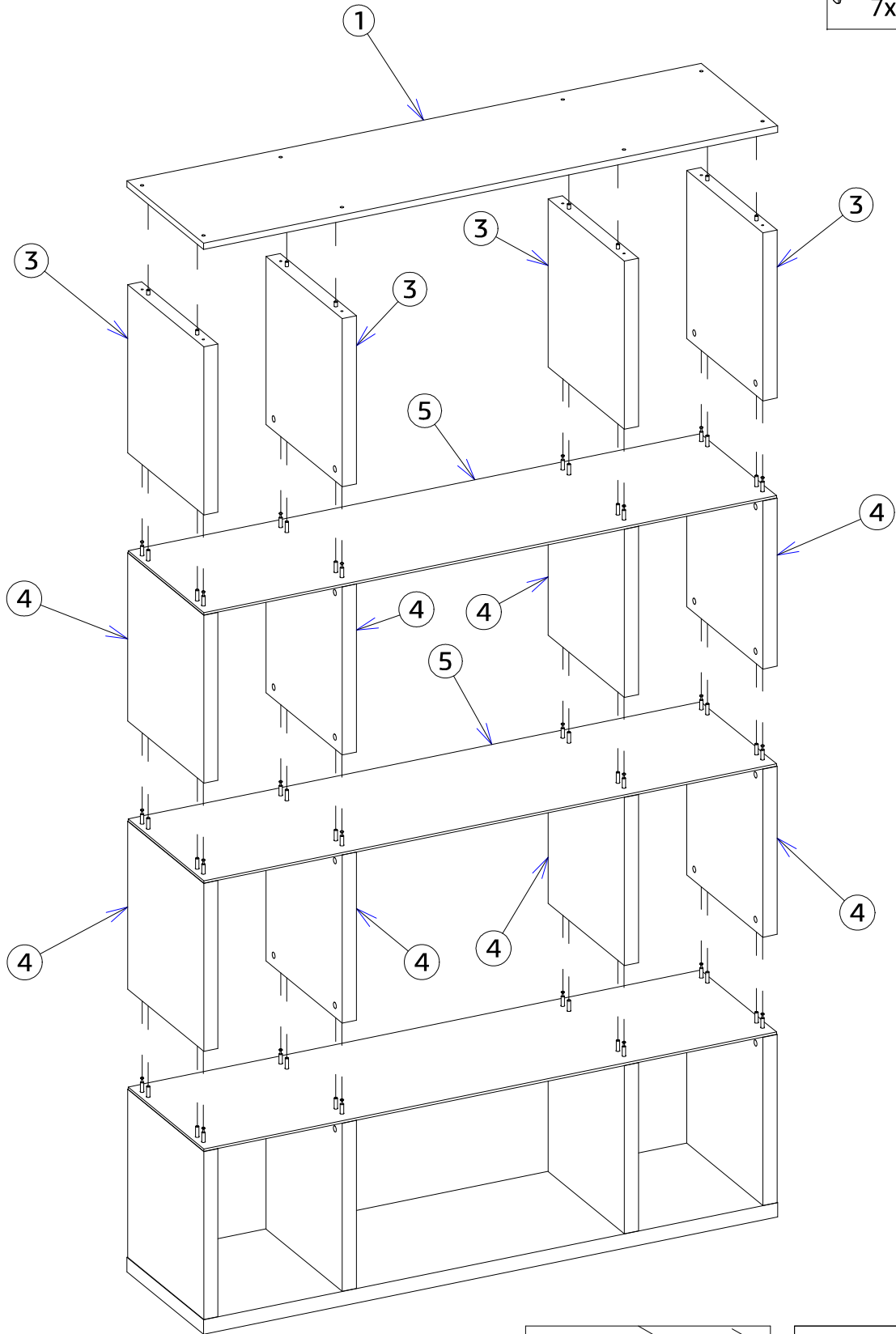

STEP 7

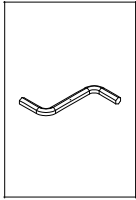

KN2 x8



5x70

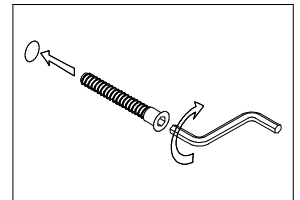
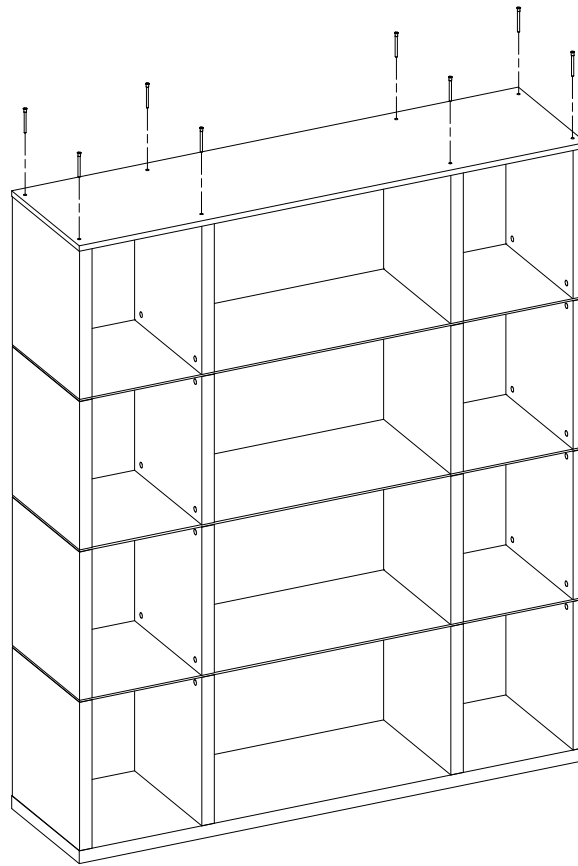

STEP 8

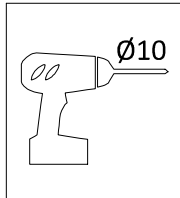
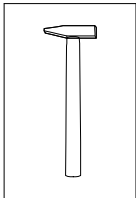
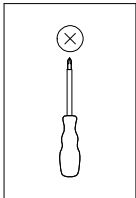

W3 x2

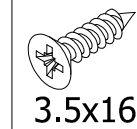

KT1 x1

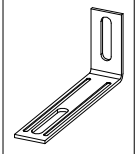

3.5x16

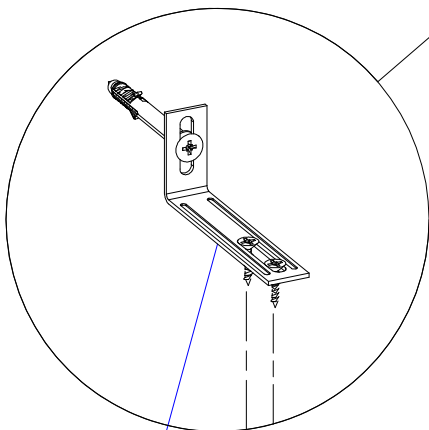

FIX TO WALL
FIX TO UNIT

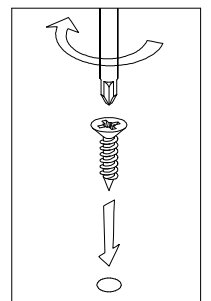
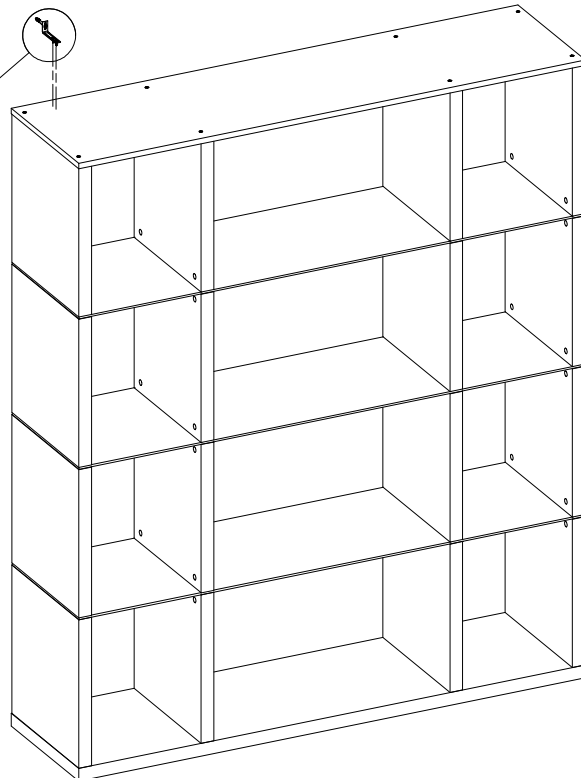

STEP 9

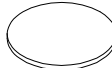
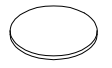
Z	x48	Z2	x8
			

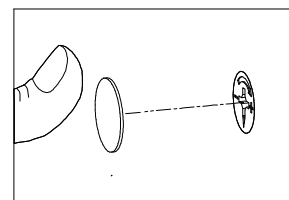
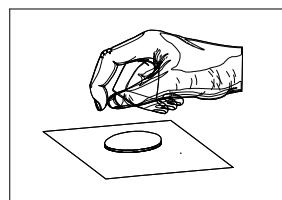
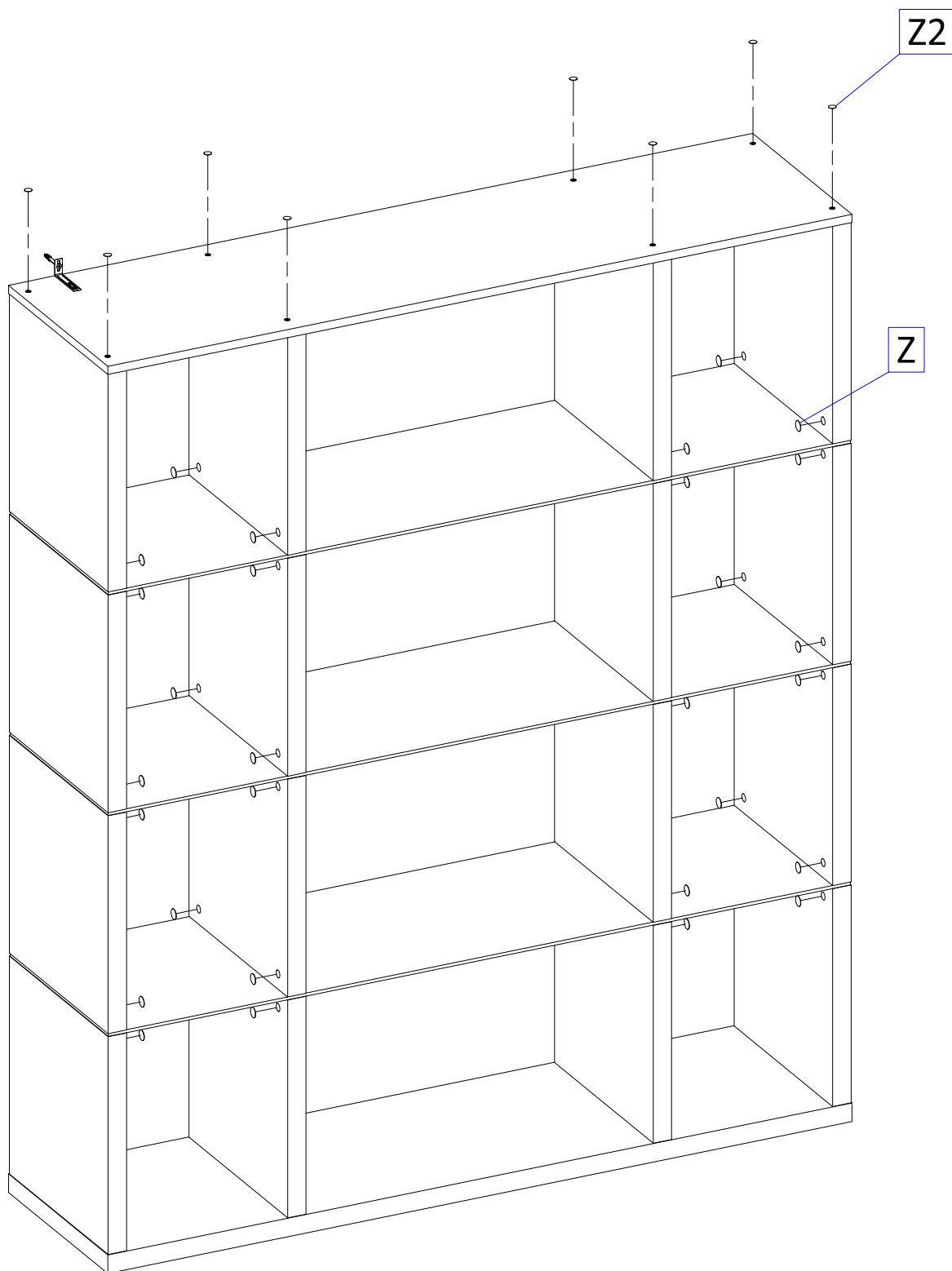

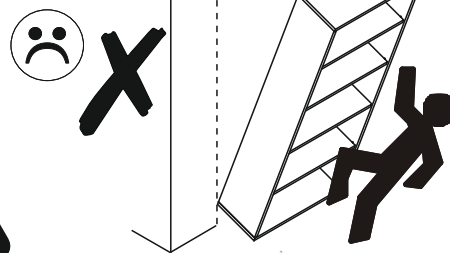
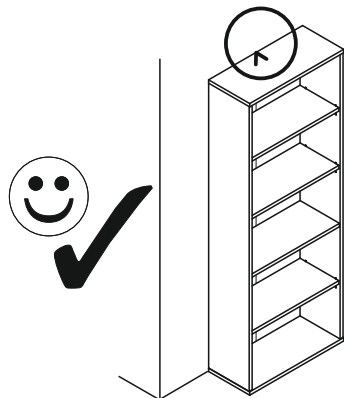

PL.

UWAGA! Mebel należy trwale zamocować do ściany, aby uniknąć ryzyka związane go z przewróceniem się mebla. W paczce znajdują się elementy mocujące odpowiednie wytyczone do ścian betonowych lub z pełnej cegły. Jeśli Twoja ściana wykonana jest z innego materiału lub nie masz pewności co do budowy tej ściany, skonsultuj się w kwestii montażu ze specjalistą.

RU.

ПРИМЕЧАНИЕ! Эту мебель необходимо всегда прикреплять к стене, чтобы избежать рисков, связанных с переворотом мебели. В пакете находятся крепительные элементы, которые подходят исключительно к бетонным стенам или из целого кирпича. Если стена изготовлена из другого материала или Вы не уверены относительно строения стены, проконсультируйтесь относительно монтажа со специалистом.

I.

ATTENZIONE! Il mobile deve essere permanentemente fissato alla parete per evitare i rischi derivanti da un ribaltamento del mobile. La confezione contiene solo elementi di fissaggio adatti per pareti in calcestruzzo o in laterizio pieno. Se la vostra parete è realizzata in materiale diverso o avete dubbi sulla costruzione della parete, consultare uno specialista per un montaggio corretto.

EN.

WARNING! To prevent this furniture from tripping over, fix it to the wall permanently. The package includes fastening elements only suitable for concrete or full-brick walls. If your wall is made of a different material or you are unsure as to the construction of the wall, please consult a specialist regarding installation.

FR.

ATTENTION! Ce meuble doit être fixé en permanence au mur pour éviter les risques de chute. L'ensemble comprend des moyens de fixation adaptés uniquement aux murs de béton ou de brique. Si votre mur est fait d'un matériau différent ou si vous êtes incertain quant à la construction du mur, consultez un spécialiste.

HR.

NAPOMENA! Namještaj mora biti trajno pričvršćen za zid, kako bi se izbjegao rizik od njegova prevrtanja. U paketu se nalaze elementi za pričvršćivanje prikladni isključivo za betonske zidove ili punu ciglu. Ako je Vaš zid izrađen od drugog materijala ili niste sigurni od čega je napravljen Vaš zid, konzultirajte se sa stručnjakom u vezi sa montažom.

CN.

注意! 本家具需要固定在墙上以免倒塌。
本包所含有的固定部件仅适用于混凝土墙及整砖墙。
欲使用在其他墙体或不确定墙体时，
请向专家询问安装方式。

D.

ACHTUNG! Um alle mit dem Umkippen des Möbels verbundenen Risiken auszuschließen, muss das Möbel fest an der Wand verankert werden. Die im Paket enthaltenen Beschläge für die Wandbefestigung sind ausschließlich für Wände aus Beton oder Vollziegeln geeignet. Sollten die heimischen Wände aus anderem Baumaterial bestehen oder sollte es Zweifel in Hinsicht auf dieses Baumaterial geben, bitte eine Fachkraft zu Rate ziehen.

HU.

FIGYELEM! Rögzítse a bútorokat a falhoz, hogy elkerülje a bútor felborulásának kockázatát. A készletben kizárólag beton- vagy téglafalhoz használható kötőelemek találhatók. Ha a fal más anyagból készült, vagy ha nem tudja, milyen falak találhatók otthonában, forduljon szakemberhez.

CZ.

POZOR! Nábytek je nutné pevně připevnit ke zdi, abychom se vyhnuli riziku spojenému s jeho převrhnutím. V balíčku se nacházejí příslušující prvky vhodné výhradně do betonových zdí nebo zdí z plných cihel. Pokud jsou Vaše zdi zhotoveny z jiného materiálu nebo si nejste jejich konstrukcí jisti, konzultujte otázku montáže se specialistou.

E.

¡ATENCIÓN! El mueble debe ser fijado permanentemente a la pared para evitar el riesgo relacionado con el vuelco del mueble. En el paquete hay elementos de fijación adecuados solo para paredes de hormigón o de ladrillo entero. Si su pared está hecha de otro material o no está seguro sobre la construcción de esta pared, consulte el montaje con un especialista.

SK.

POZOR! Nábytok musí byť trvalo pripevnený k stene tak, aby sa zamedzilo riziku prevrátenia. V balíku sa nachádzajú upevňovacie komponenty výlučne pre betónové steny alebo steny z plnej tehly. Ak je Vaša stena z iného materiálu alebo ak si nie ste istí, z čoho je stena vyhotovená, vyžadajte si odbornú pomoc.

SLO.

POZOR! Pohištvó trajno pritrđite na steno, da preprečite tveganje, da se prevrne. V paketu so pritrđilni elementi, ki so ustrezni izključno za betonske stene in za stene iz polne opeke. Če je vaša stena izdelana iz drugih materialov ali niste gotovi glede konstrukcije stene, se o montaži posvetujte s strokovnjakom.

PL.

UWAGA! Mebel należy trwale zamocować do ściany, aby uniknąć ryzyka związane go z przewróceniem się mebla. W paczce znajdują się elementy mocujące odpowiednie wytyczone do ścian betonowych lub z pełnej cegły. Jeśli Twoja ściana wykonana jest z innego materiału lub nie masz pewności co do budowy tej ściany, skonsultuj się w kwestii montażu ze specjalistą.

SK.

POZOR! Nábytok musí byť trvalo pripevnený k stene tak, aby sa zamedzilo riziku prevrátenia. Balík neobsahuje upevňovacie skrutky, pretože typ upevnenia je treba vybrať podľa typu steny. Vyberte typ vhodný pre Vašu stenu.

FR.

ATTENTION! Ce meuble doit être fixé en permanence au mur pour éviter les risques de chute. Les vis de fixation ne sont pas livrées car le type de fixation doit être choisi en fonction du type de mur. Sélectionnez les fixations adaptées au mur.

D.

ACHTUNG! Um alle mit dem Umkippen des Möbels verbundenen Risiken auszuschließen, muss das Möbel fest an der Wand verankert werden. Beschläge für die Wandbefestigung sind nicht beige packt, da diese von der jeweiligen Wandbeschaffenheit abhängig sind. Bitte solche Befestigungsschläge wählen, die für die heimischen Wände geeignet sind.

EN.

WARNING! To prevent this furniture from tripping over, fix it to the wall permanently. Fixing devices are not included since different wall materials require different types of fixing devices. Please make sure you chose the correct ones for your type of wall.

I.

ATTENZIONE! Il mobile deve essere permanentemente fissato alla parete per evitare i rischi derivanti da un ribaltamento del mobile. La confezione non include le viti di fissaggio, in quanto il tipo di fissaggio deve essere scelto in base al tipo di parete. Utilizzare viti appropriate in base al materiale della parete.

SLO.

POZOR! Pohištvó trajno pritrđite na steno, da preprečite tveganje, da se prevrne. V paketu ni pritrđilnih vijakov, saj je treba način pritrđitve ustrezno izbrati glede na vrsto stene. Izberite način, ki je ustrezen za vašo steno.

RU.

ПРИМЕЧАНИЕ! Эту мебель необходимо всегда прикреплять к стене, чтобы избежать рисков, связанных с переворотом мебели. В пакете нет крепежных винтов, потому что тип крепления должен быть выбран в соответствии с типом стены. Выберите, пожалуйста, правильные винты к вашей стене.

CZ.

POZOR! Nábytek je nutné pevně připevnit ke zdi, abychom se vyhnuli riziku spojenému s jeho převrhnutím. Součástí balení nejsou upevňovací šrouby, protože způsob upevnění je nutné zvolit podle druhu stěny. Vyberte správný pro Váš typ stěny

CN.

注意! 本家具需要固定在墙上以免倒塌。箱子里没有安装螺钉。因为安装方式需要根据墙的类型调整。请按照您的墙类型选择合适的安装方式。

HU.

FIGYELEM! Rögzítse a bútorokat a falhoz, hogy elkerülje a bútor felborulásának kockázatát. A készletben nincsenek rögzítőcsavarok, mivel a rögzítés típusa a fal típusától függ. Válassza ki a fal típusának megfelelő kötőelemeket

HR.

NAPOMENA! Namještaj mora biti trajno pričvršćen za zid, kako bi se izbjegao rizik od njegova prevrtanja. U paketu nema vijaka za pričvršćivanje, jer se vrsta montaže mora prilagoditi vrsti zida. Odaberite pravu vrstu prema Vašoj vrsti zida.

E.

¡ATENCIÓN! El mueble debe ser fijado permanentemente a la pared para evitar el riesgo relacionado con el vuelco del mueble. En el paquete no hay tornillos de fijación, ya que se debe elegir el tipo de fijación adecuado para el tipo de pared. Elija el apropiado para su tipo de pared.

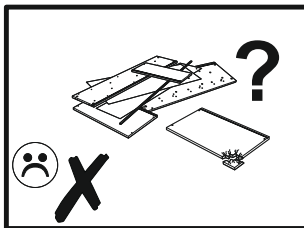
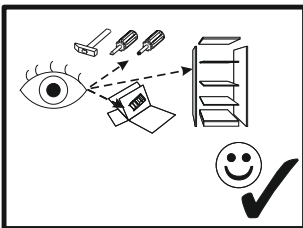

D: ALLGEMEINE HINWEISE FÜR MÖBEL AUS HOLZ UND HOLZWERKSTOFFE: MELAMIN, LAMINAT, ARMATURENBRETT
Zu reinigen, verwenden Sie ein feuchtes Tuch. Verwenden Sie nur Wasser oder ein mildes Reinigungsmittel. Wischen Sie mit einem Tuch trocken.

GB: GENERAL INSTRUCTIONS FOR FURNITURE OF WOOD AND WOOD MATERIALS: MELAMINE, LAMINATE, DASHBOARD
To clean, use a damp cloth. Use only water or a mild detergent. Wipe dry with a cloth.

ES: INSTRUCCIONES GENERALES PARA MUEBLES DE MADERA Y MATERIALES: MELAMINA, LAMINADO, TABLERO DE INSTRUMENTOS
Para limpiar, utilice un paño húmedo. Utilice sólo agua o un detergente suave. Seque con un paño

FR: INSTRUCTIONS GENERALES DE MEUBLES DE MATÉRIAUX DE BOIS ET: MÉLAMINÉS, STRATIFIÉS, TABLEAU DE BORD
Pour nettoyer, utilisez un chiffon humide. d'eau ou d'un détergent doux. Essuyer avec un chiffon.

CZ: VŠEOBECNÉ POKYNY PRO NÁBYTEK ZE DŘEVA A DŘEVĚNÝCH MATERIÁLŮ: MELAMINE, LAMINÁT, DASHBOARD
K čištění použijte vlhký hadřík. Používejte pouze vodu nebo jemným čistícím prostředkem. Vytřete do sucha hadříkem.

PL: OGÓLNE INSTRUKCJE DOTYCZĄCE MEBLI Z DREWNA ORAZ MATERIAŁÓW DREWNOPOCHODNYCH: MELAMINA, LAMINAT, OKLEINA
Do czyszczenia należy używać wilgotnej ściereczki. używać wyłącznie wody lub delikatnego detergentu. Wycierać do sucha ściereczką.

HU: A BÚTOR ÁLTALÁNOS FAANYAGOK ÉS FAIPARI ANYAGOK: MELAMIN, LAMINÁT, MÚSZERFAL
A tisztításhoz használjon egy nedves ruhával. Csak vizet vagy enyhe tisztítószerrel. Töröld szárazra egy ronggyal.

HU: A BÚTOR ÁLTALÁNOS FAANYAGOK ÉS FAIPARI ANYAGOK: MELAMIN, LAMINÁT, MÚSZERFAL
A tisztításhoz használjon egy nedves ruhával. Csak vizet vagy enyhe tisztítószerrel. Töröld szárazra egy ronggyal.

SK: VŠEOBECNÉ POKYNY PRO NÁBYTEK ZE DŘEVA A DŘEVĚNÝCH MATERIÁLŮ: MELAMINE, LAMINÁT, DASHBOARD
Na čistenie použite vlhkú handričku. používajte iba vodu alebo jemným čistiacim prostriedkom. Vytrite dosucha handričkou.

RU: ОБЩИЕ ПРАВИЛА ДЛЯ МЕБЕЛИ ДРЕВЕСИНЫ И ДРЕВЕСНЫХ МАТЕРИАЛОВ: МЕЛАМИН, ЛАМИНАТ, ПАНЕЛЬ
Для очистки используйте влажную ткань. Используйте только воду или мягкое моющее средство. Протрите сухой тряпкой.

IT: ISTRUZIONI GENERALI PER MOBILI DI LEGNO E LEGNO MATERIALI: MELAMINICO, LAMINATO, CRUSCOTTO
Per la pulizia, utilizzare un panno umido. Utilizzare solo acqua o un detergente neutro. Asciugare con un panno.

RO: INSTRUCȚIUNI GENERALE DE MOBILIER DE LEMNOASA ?I MATERIALE LEMNOASE: PAL, LAMINAT, TABLOU DE BORD
Pentru a cură?a, folosi?i o carpa umeda. Folosi?i numai apa sau un detergent slab. Sterge cu o carpa.

TR: AHŞAP VE AHŞAP MALZEMELERIN MOBILYA İÇİN GENEL BİLGİLER: MELAMIN, LAMINAT, PANEL
Temizlemek için, nemli bir bez kullanın. Sadece su veya hafif bir deterjan kullanın. Bir bez ile kurulayın.

NL: ALGEMENE RICHTLIJNEN VOOR MEUBELEN VAN HOUT EN HOUTPRODUCTEN MATERIALEN: MELAMINE, LAMINAAT, DASHBOARD
Schoon te maken, gebruikt u een vochtige doek. Gebruik alleen water of een mild schoonmaakmiddel. Veeg met een doek droog.

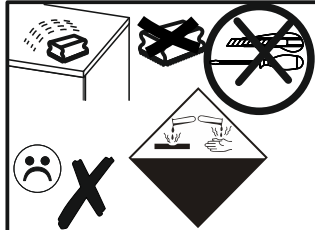
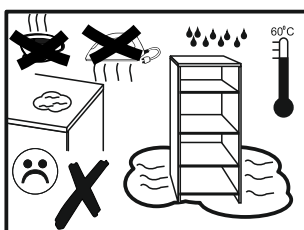
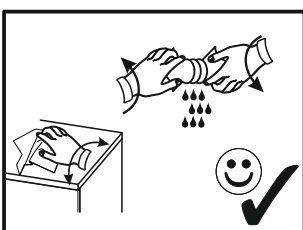
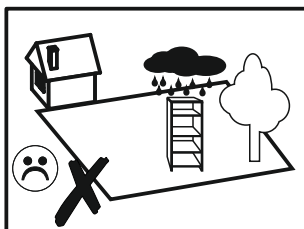
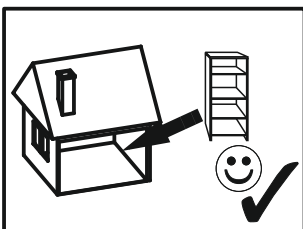
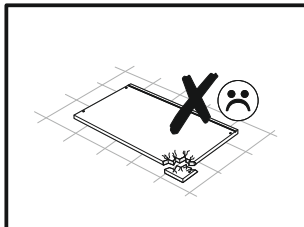
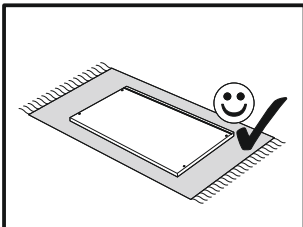
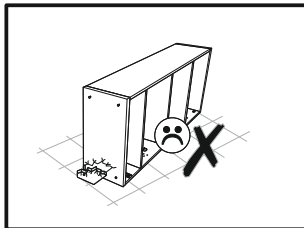
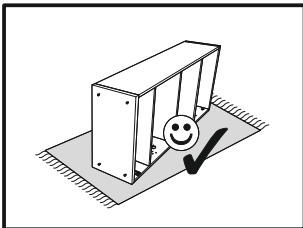
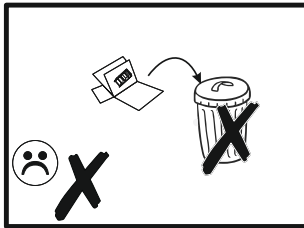
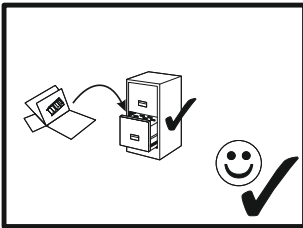

PL: Komplementowanie akcesorii oraz proces pakowania odbywa się pod nadzorem kontroli jakości oraz monitoringu.

EN: Complementing the accessories and the packaging process is carried out under the supervision of quality control and monitoring.

DE: Die Ergänzung des Zubehörs und des Verpackungsprozesses erfolgt unter der Aufsicht der Qualitätskontrolle und -überwachung.

FR: Le complément des accessoires et du processus d'emballage s'effectue sous la supervision d'un contrôle et d'une surveillance de la qualité.

IMPORTANT SAFETY INFORMATION

WALL MOUNTING FURNITURE SAFETY INFORMATION AND WARNING

ATTENTION: This article provides basic information for mounting your wall mounted floating furniture to a wall using a wall mount bracket.

WARNING! There's a risk of damage to your furniture and wall and injury to person if you don't follow the assembly or installation instructions correctly. We're not liable for any damages or injury caused by mishandling or improper installation of the wall-mount bracket.

WARNING! If you use substitute items other than the supplied screws, the furniture may fall and cause physical injury to someone or damage to the furniture and/or wall.

WARNING! Do not attempt to mount furniture that is not sold as wall mounting furniture.

We strongly recommend that a qualified professional install your furniture on the wall for product protection and safety reasons. Sufficient expertise is required to determine the strength of the wall for withstanding the furniture's weight.

Check the wall-mount installation manual supplied with your furniture for Information on how to properly mount your furniture. We don't guarantee the use of third-party wall mount brackets or screws.

Use the screws supplied with the wall-mount bracket when you attach the wall-mount bracket to the furniture.

Any repairs or modifications done to the included wall mount bracket or any part of the wall mounted furniture are not recommended, and may cause an increased risk of damage to your furniture and wall, and potentially injury to person. Any repairs or modifications will void all warranty and technical support for this unit.

SAVE THIS SAFETY INFORMATION AND WARNING FOR FUTURE REFERENCE

PL - UWAGA!

Nasze powierzchnie o wysokim połysku są fabrycznie ochronione specjalną folią ochronną. Prosimy pozostawić ją na meblach do momentu zmontowania i usunięcia kurzu. Po usunięciu folii ochronnej pozostawić folię połyskową przez 24 godziny w pomieszczeniu do stwardnienia.

EN - ATTENTION!

Our high gloss surfaces have a protective foil when delivered. Please leave this foil on the furniture until it is completely assembled and all dust has been removed. Expose the high gloss foil to the room air for 24 hours to allow it to harden after removing the protective foil.

DE - HINWEIS!

Unsere Hochglanzoberflächen sind bei der Auslieferung durch eine Schutzfolie geschützt. Belassen Sie diese auf dem Möbel, bis es vollständig montiert und von Staub befreit ist. Der Hochglanzfolie nach der Entfernung der Schutzfolie 24 Stunden Zeit zum Nachhärten an der Raumluft geben.

CZ - POZOR!

Naše povrchy s vysokým leskem jsou při dodání chráněny ochrannou fólií. Ponechte ji na nábytku, dokud nebude kompletně smontovaný a nebude z něho odstraněn prach. Po odstranění folie dejte nábytku 24 hodin čas na vytvrzení v pokojové teplotě.

SK - POZOR!

Naše vysoko lesklé povrchy sú chránené špeciálnou ochrannou fóliou. Prosím, nechajte ju nanábytku, kým nábytok nezmontujete a neodstránite prach. Po odstránení ochrannej fólie nechajte lesklý film 24 hodín v miestnosti vytvrdnúť.

HU - FIGYELEM!

Az általunk gyártott bútorok magas fényű felületei speciális védőfóliával gyárilag védettek. Kérjük a védő fóliát ne távolítsák el a bútor összeszereléséig, és a por szerelést követő eltávolításáig. A védőfólia eltávolítását követően tartsuk a bútort 24 órán át a fóliázott felületek megkeményedésére alkalmas környezetben.

HR - PAŽNJA!

Dijelovi namještaja u visokom sjaju imaju na sebi zaštitnu foliju prilikom isporuke. Molimo vas da tu foliju ostavite na namještaju dok nije u potpunosti montiran i dok nije odstranjena sva prašina u prostoru. Nakon uklanjanja zaštitne folije dijelove namještaja u visokom sjaju izložiti sobnom zraku 24 sati.

