

SPECIFICATIONS

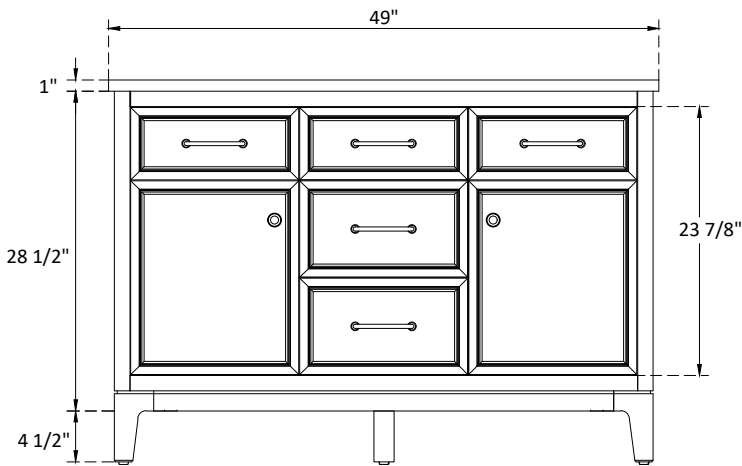

Handle :
Overall length : 5 3/4" (147mm)
center to center : 5" (128mm)

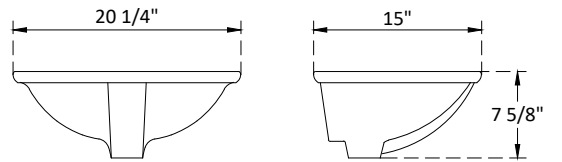
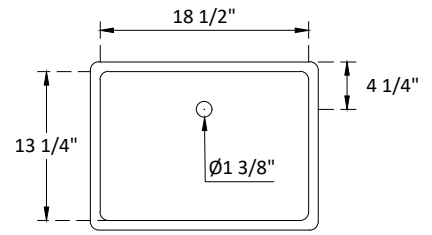
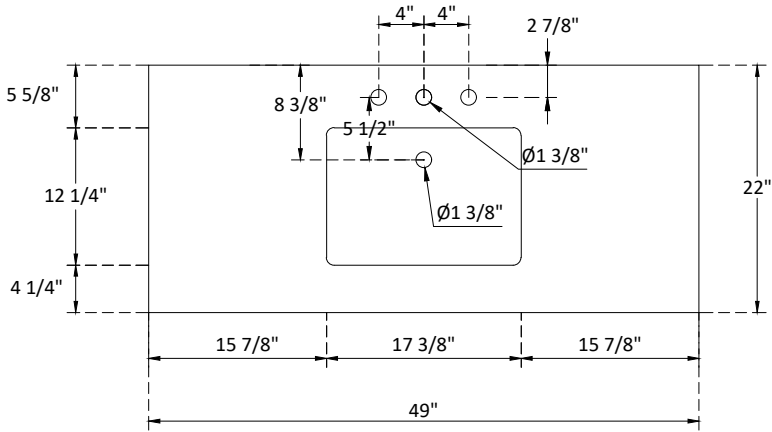