



















ASSEMBLY INSTRUCTION

Thank you for purchasing this quality product. Be sure to check all packing material carefully for small parts which may have come loose inside the carton during shipment. Separate, identify and count all parts and hardware. Compare with the part list to be sure all parts are present. If any part(s) are missing or damaged, please contact your local furniture dealer. For efficient and speedy service, please indicate the model number and code letter of part(s) needed”

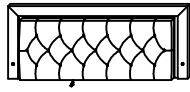
"DO NOT TIGHTEN SCREWS UNTIL COMPLETELY ASSEMBLED"

IMPORTANT:
PLEASE READ INSTRUCTION BEFORE STARTING THE ASSEMBLY

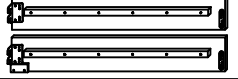
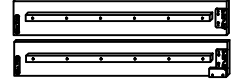
HARDWARE LIST				
ITEM	DESCRIPTION	DRAWING	SIZE	QTY
A	JCBC SCREW		M8 x 16MM	8 PCS
B	JCBC SCREW		M8 x 20MM	8 PCS
C	JCBC SCREW		M8 x 25MM	8 PCS
D	JCBC SCREW		M8 x 35MM	6 PCS
E	JCBC SCREW		M6 x 50MM	4 PCS
F	SPRING WASHER		M8 x 14MM	14 PCS
G	FLAT WASHER		M8 x 22MM	14 PCS
H	SCREW		M4 x 32MM	8 PCS
I	L - KEY		M4 x 65MM	1 PC
J	L - KEY		M5 x 65MM	1 PC
K	PLUG WITH CONNECTOR WIRE		-	1 PC
L	FOOTBOARD METAL SUPPORT LEG		-	1 PC

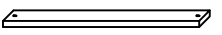
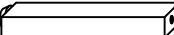
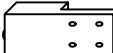
PART LIST			
ITEM	DESCRIPTION	DRAWING	QTY
1	HEADBOARD		1 PC
2	HEADBOARD LEG(R)		1 PC
3	HEADBOARD LEG(L)		1 PC
4	FOOTBOARD		1 PC
5	SIDE RAIL(i)		2 PCS
6	SIDE RAIL(ii)		2 PCS
7	ROLL SLAT		2 SETS
8	CENTRE SUPPORT RAIL		2 PCS
9	CENTRE SUPPORT LEG		4 PCS
10	SIDE RAIL SUPPORT LEG		2 PCS

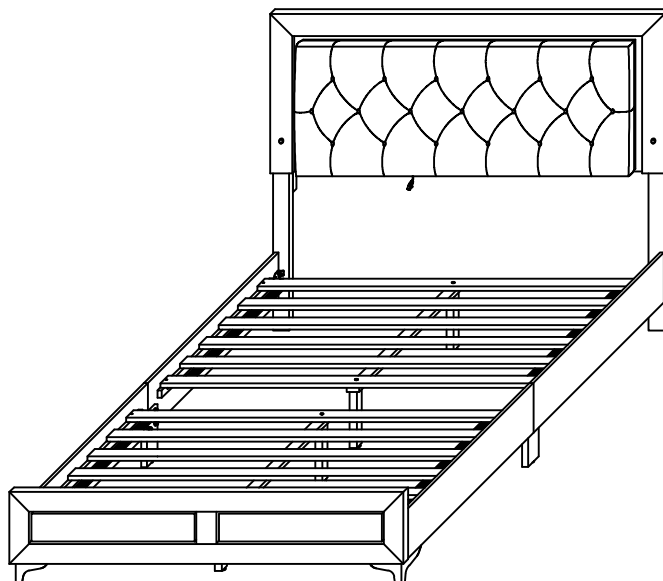

Attention

*** Some number parts listed on the instruction sheet may not be in parts bag as they may already be assembled. Carefully check parts and packing materials prior to ordering replacements.

ASSEMBLY INSTRUCTION

STEP 5

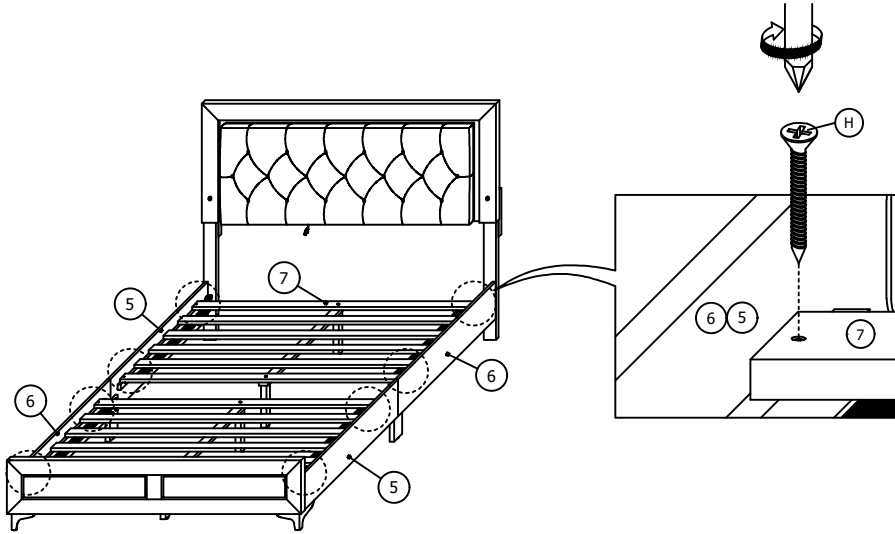

STEP 6

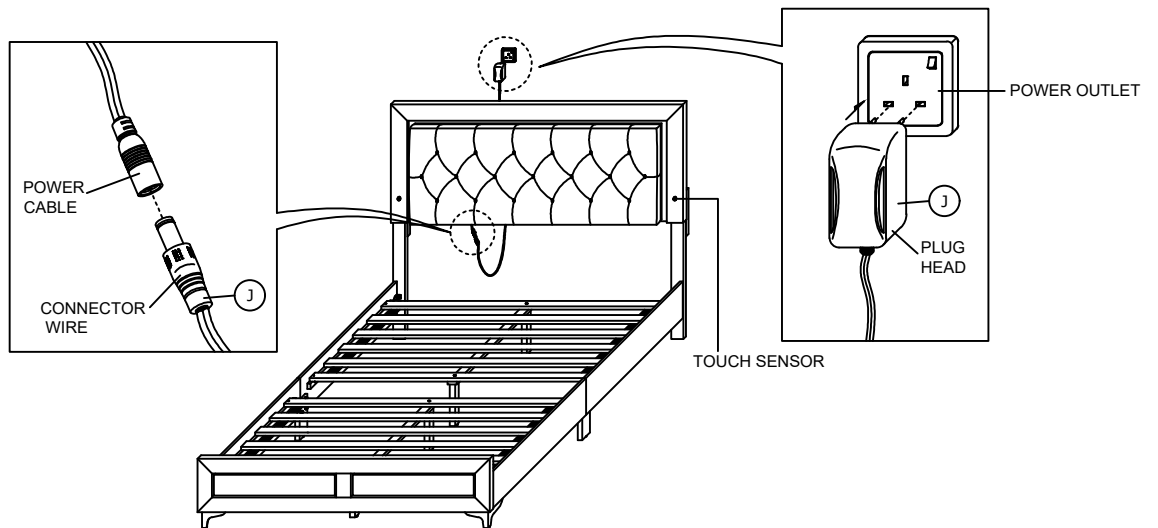

STEP 7

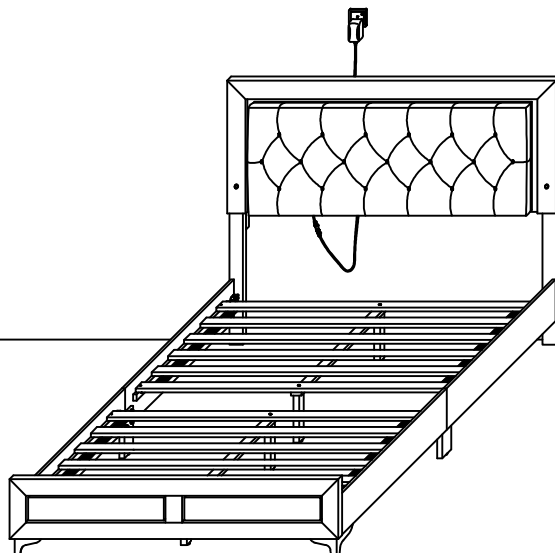

ASSEMBLY
COMPLETED