

ASSEMBLY INSTRUCTION

SKU CODE: (WF314485-WF314486)

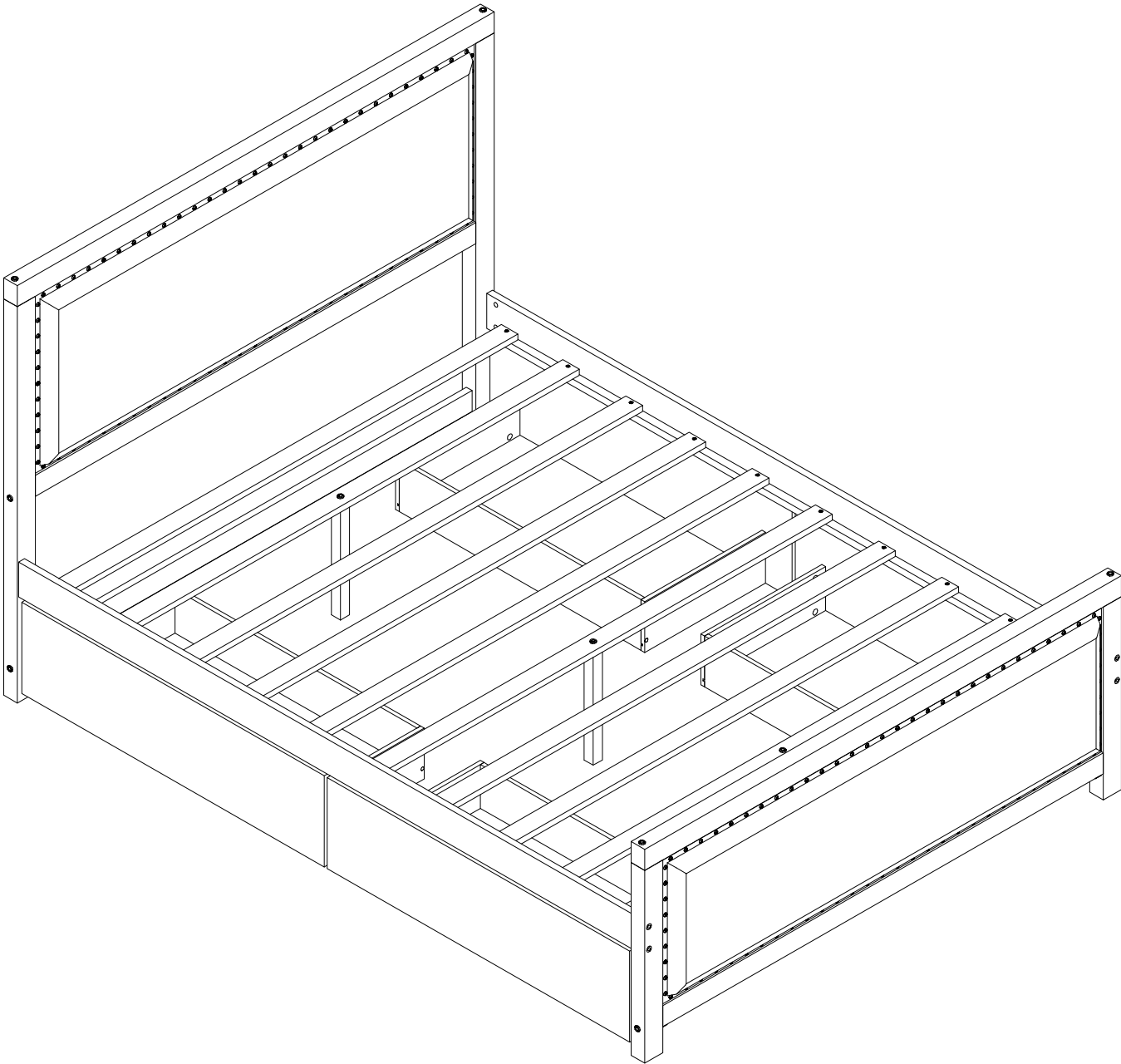

ASSEMBLY INSTRUCTION

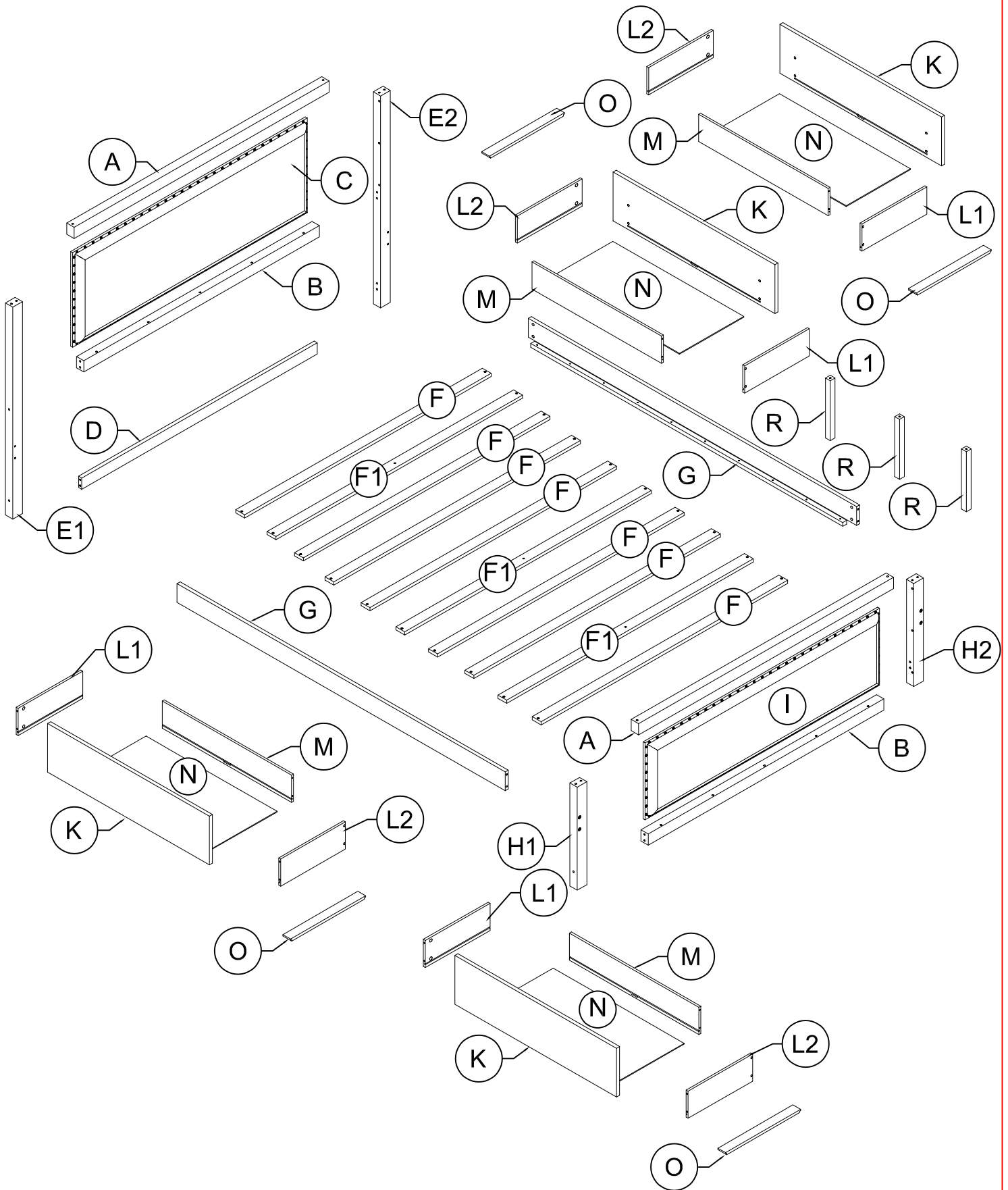

Part List (WF314485)

C

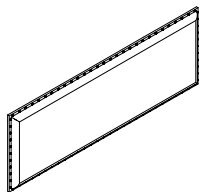

HB Frames - 1pc

I

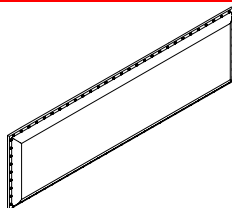

FB Frames - 1pc

K

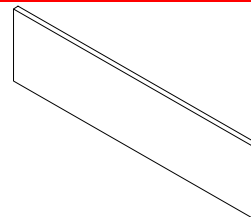

Drawers - Font Panel - 4pcs

L1

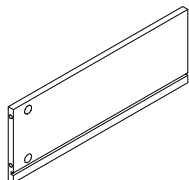

Drawers - Side Panel (Left) - 4pcs

L2

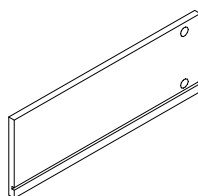

Drawers - Side Panel (Right) - 4pcs

M

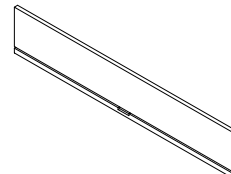

Drawers - Back Panel - 4pcs

N

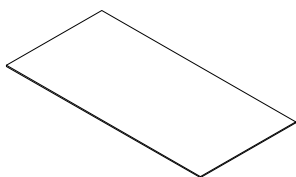

Drawers - Bottom Panel - 4pcs

O

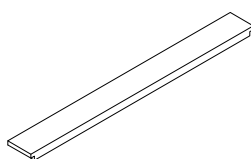







Drawers - Support Bottom - 4pcs

R

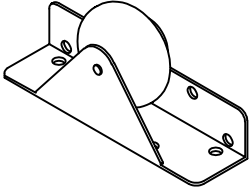

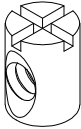
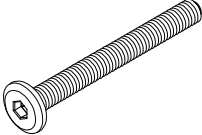
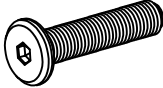
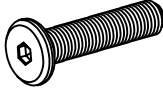
Support Leg - 3pcs

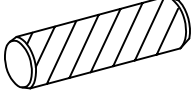
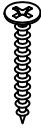
Hardware List (WF314485)

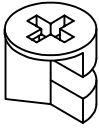
<p>1</p>  <p>Wheels 16pcs</p>	<p>2</p>  <p>Allen Key 1pc</p>	<p>3</p>  <p>1/4" x 15mm Sleeve Nut 18pcs</p>
<p>4</p>  <p>1/4" x 100mm Hex-Head bolts 10pcs</p>	<p>5</p>  <p>1/4" x 80mm Hex-Head bolts 8pcs</p>	<p>6</p>  <p>1/4" x 30mm Hex-Head bolts 3pcs</p>
<p>7</p>  <p>Plastic Drawer Stopped 8pcs</p>	<p>8</p>  <p>Steel Bracket 20pcs</p>	<p>9</p>  <p>Ø8 x 30mm Wood Dowel 42pcs</p>
<p>10</p>  <p>M4 x 30 mm Wood Screws 36pcs</p>	<p>11</p>  <p>M4 x 15 mm Wood Screws 80pcs</p>	<p>12</p>  <p>Links 1 - 16pcs</p>
<p>13</p>  <p>Links 2 - 16pcs</p>		

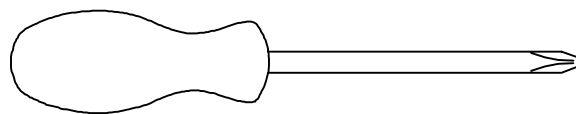

Assembly Tools Required (Not Included)

Part List (WF314486)

A

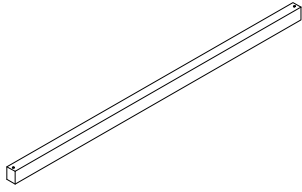

Cross Bar - 2pcs

B

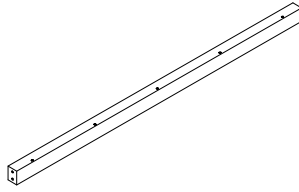

Cross Bar - 2pcs

D

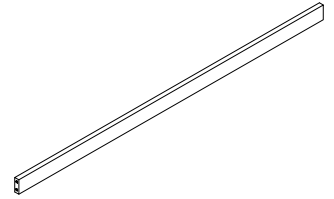

Cross Bar - 1pc

E1

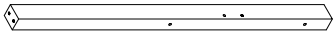

Legs - 1pc

E2

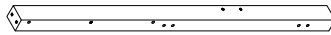

Legs - 1pc

F

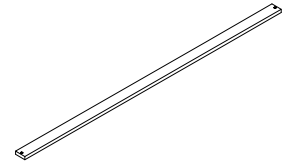

Slats - 7pcs

F1

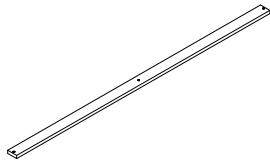

Slats - 3pcs

G

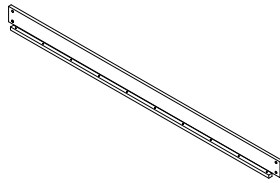

Side Rails - 2pcs

H1



Legs - 1pc

H2



Legs - 1pc

STEP 1: Following below illustration:

9

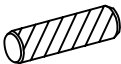

5pcs

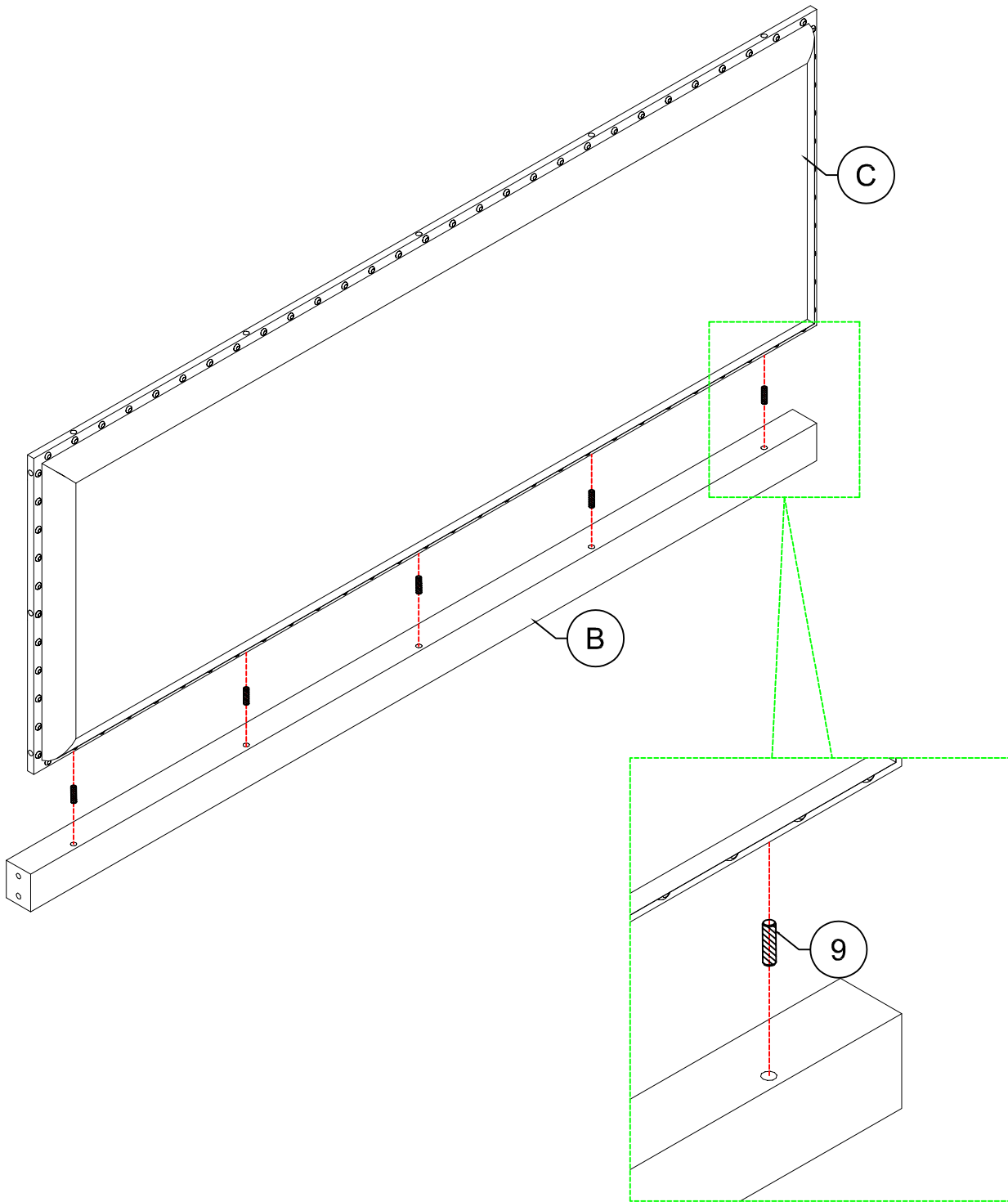

STEP 2: Following below illustration:

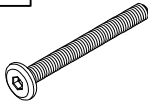
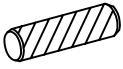
3	4	9
		
4pcs	4pcs	10pcs

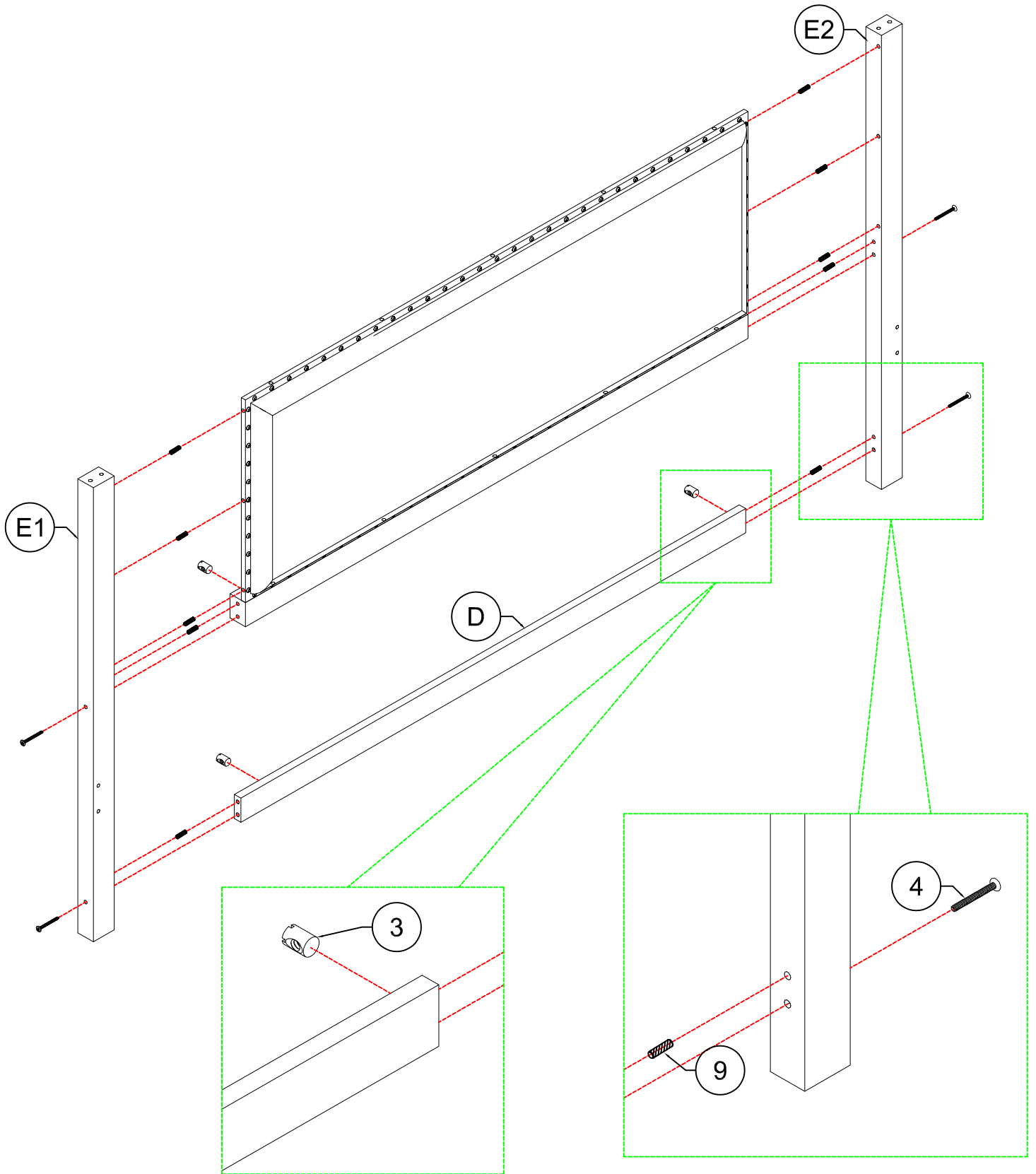

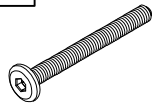
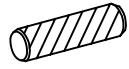

STEP 3: Following below illustration:

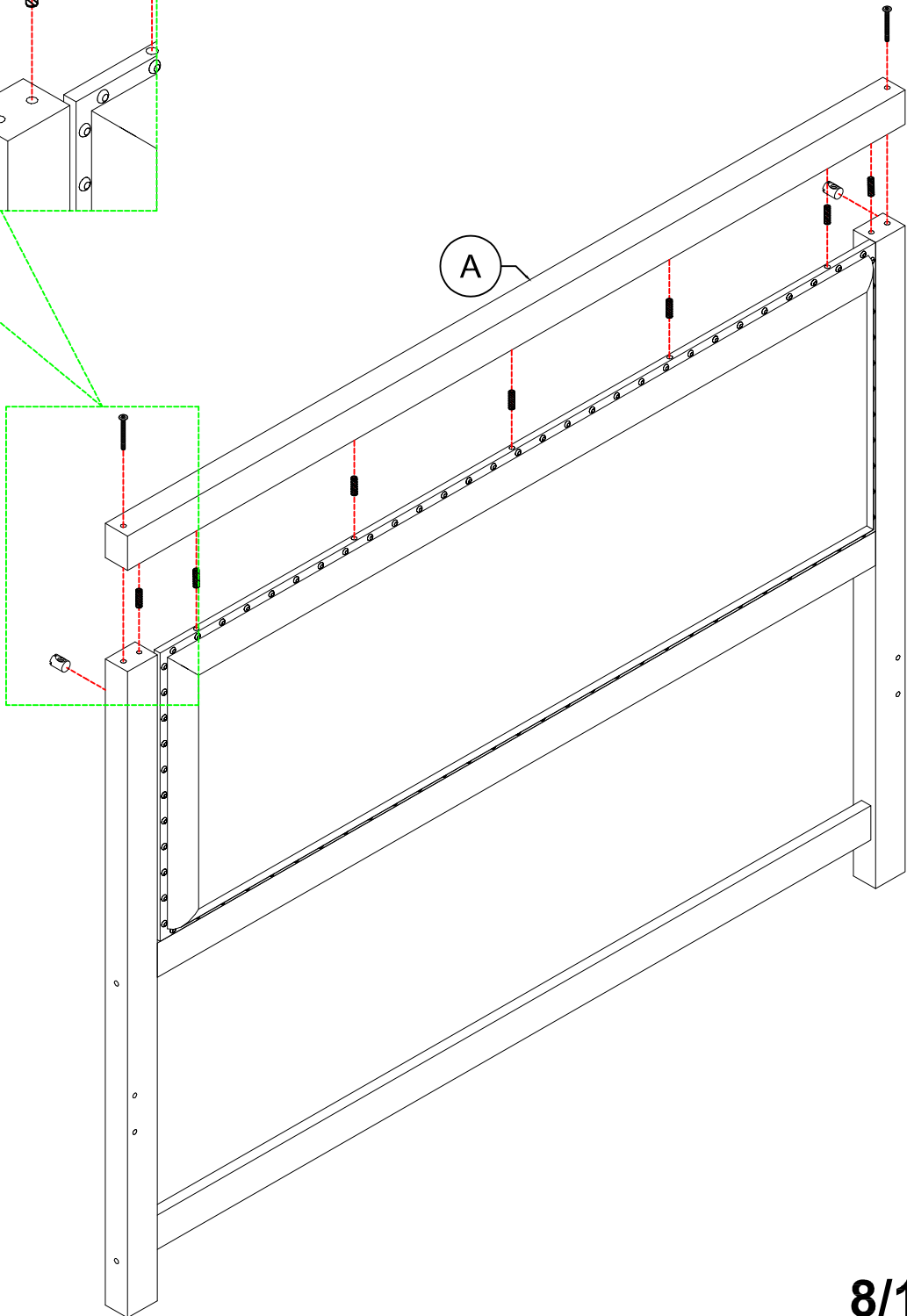
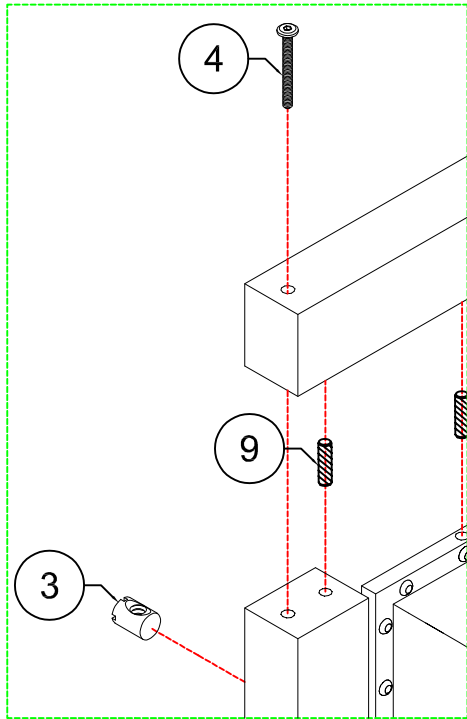
3	4	9
		
2pcs	2pcs	7pcs



STEP 4: Following below illustration:

8	11
	
10pcs	20pcs

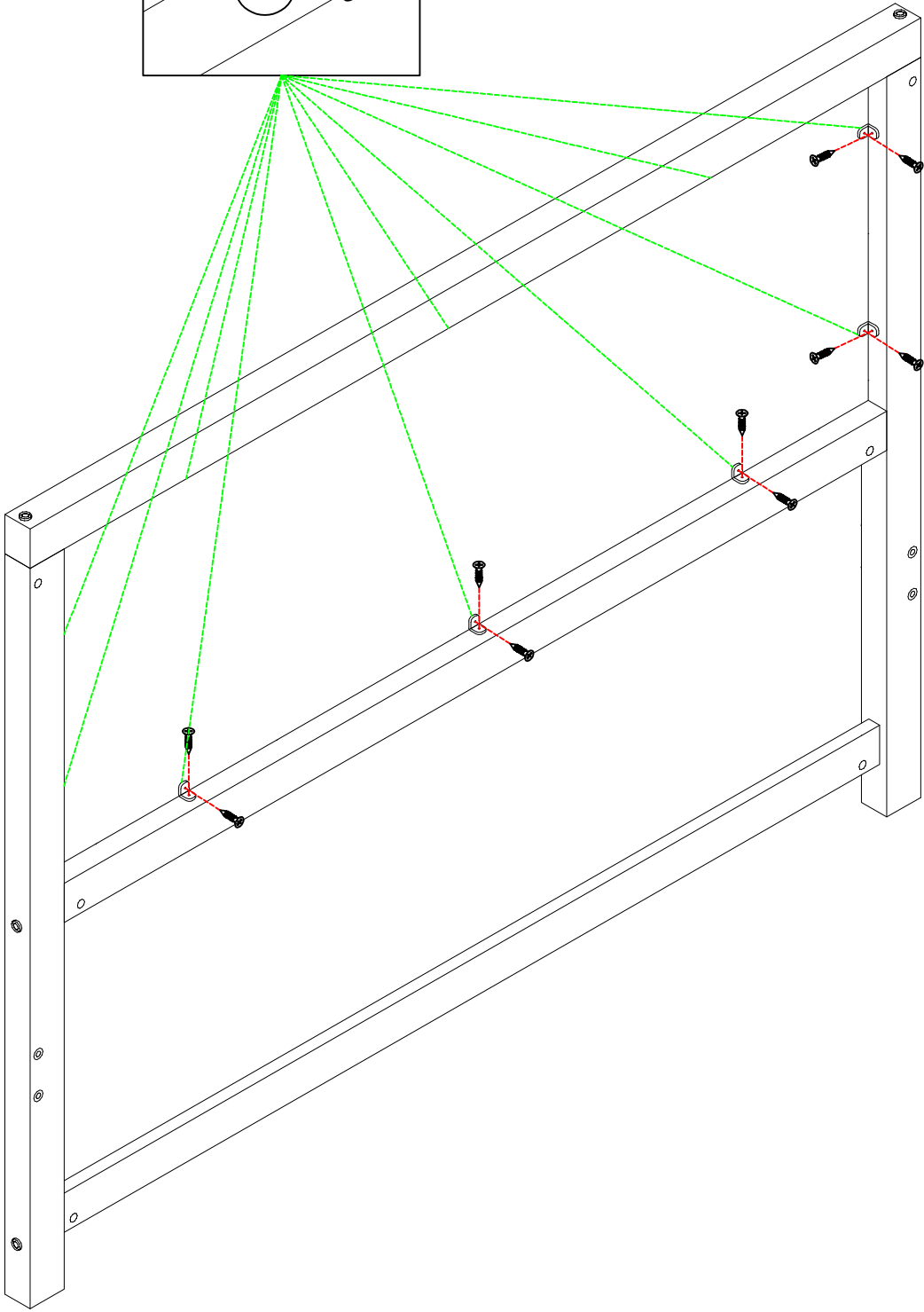
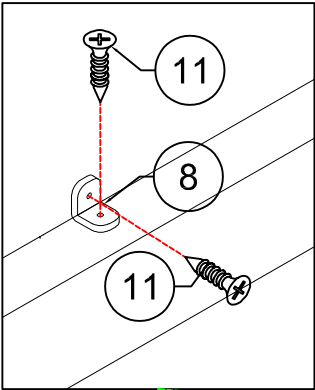

STEP 5: Following below illustration:

9

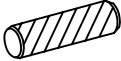

5pcs

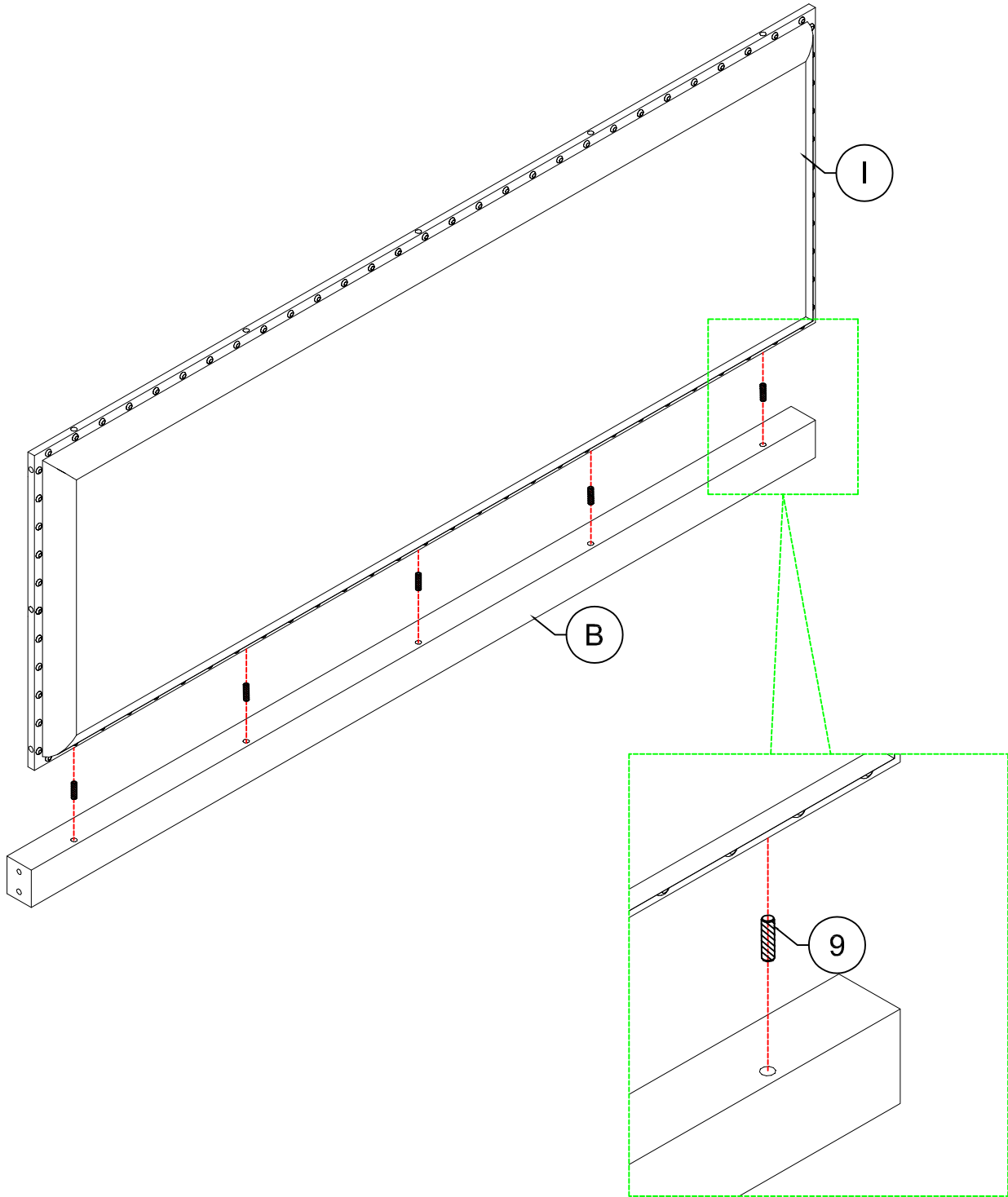

STEP 6: Following below illustration:

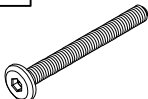
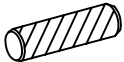
3	4	9
		
2pcs	2pcs	8pcs

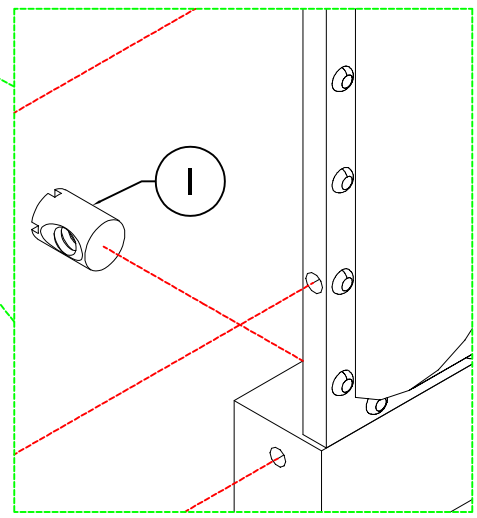
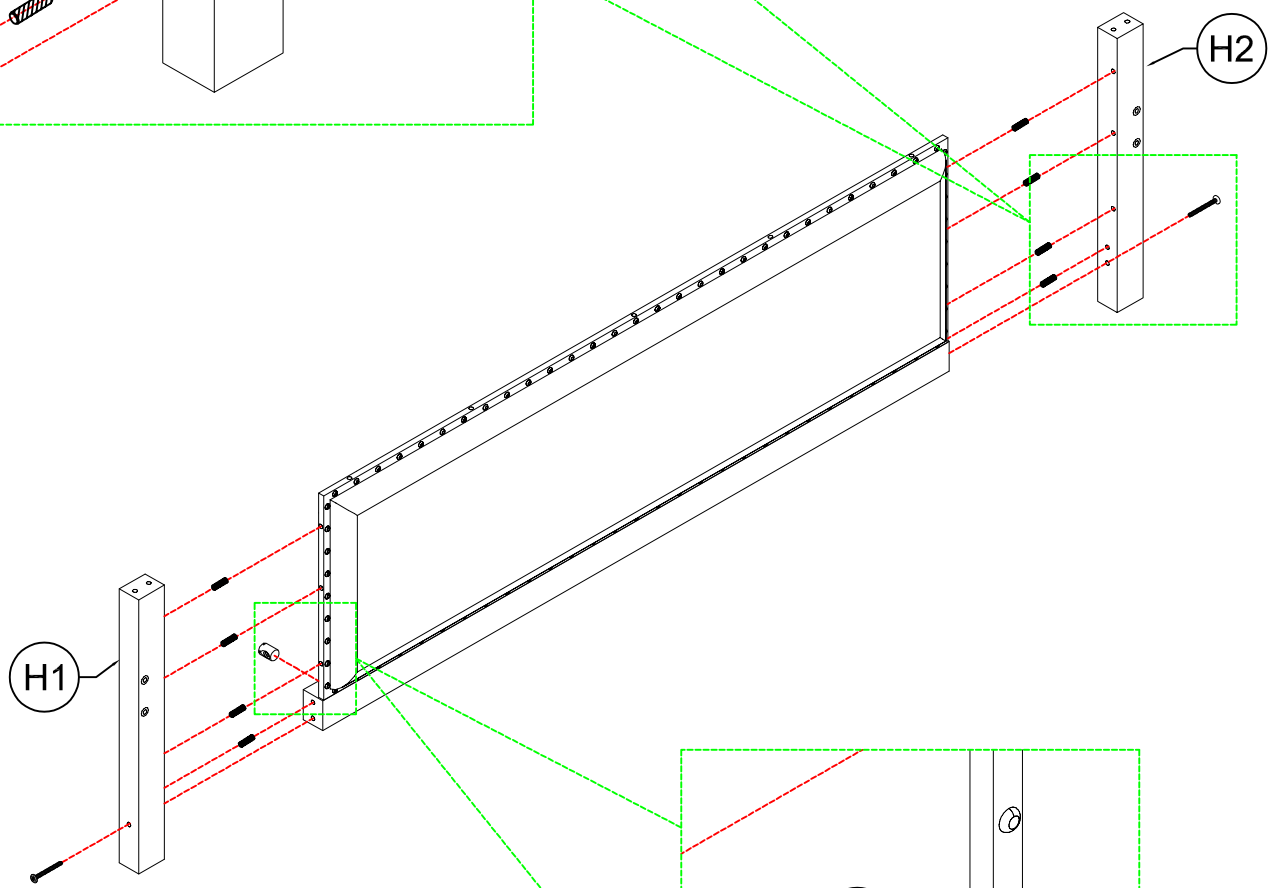
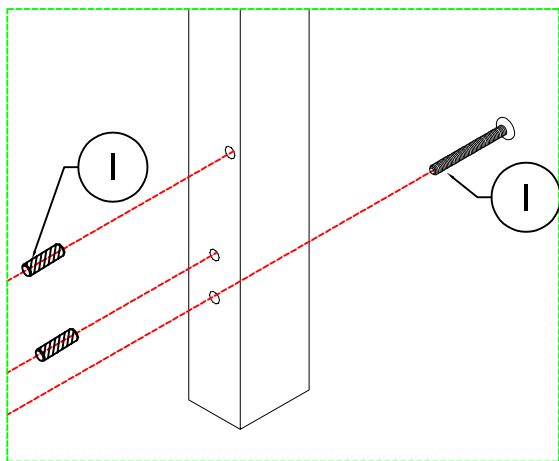

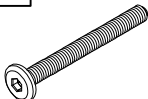
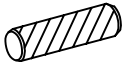

STEP 7: Following below illustration:

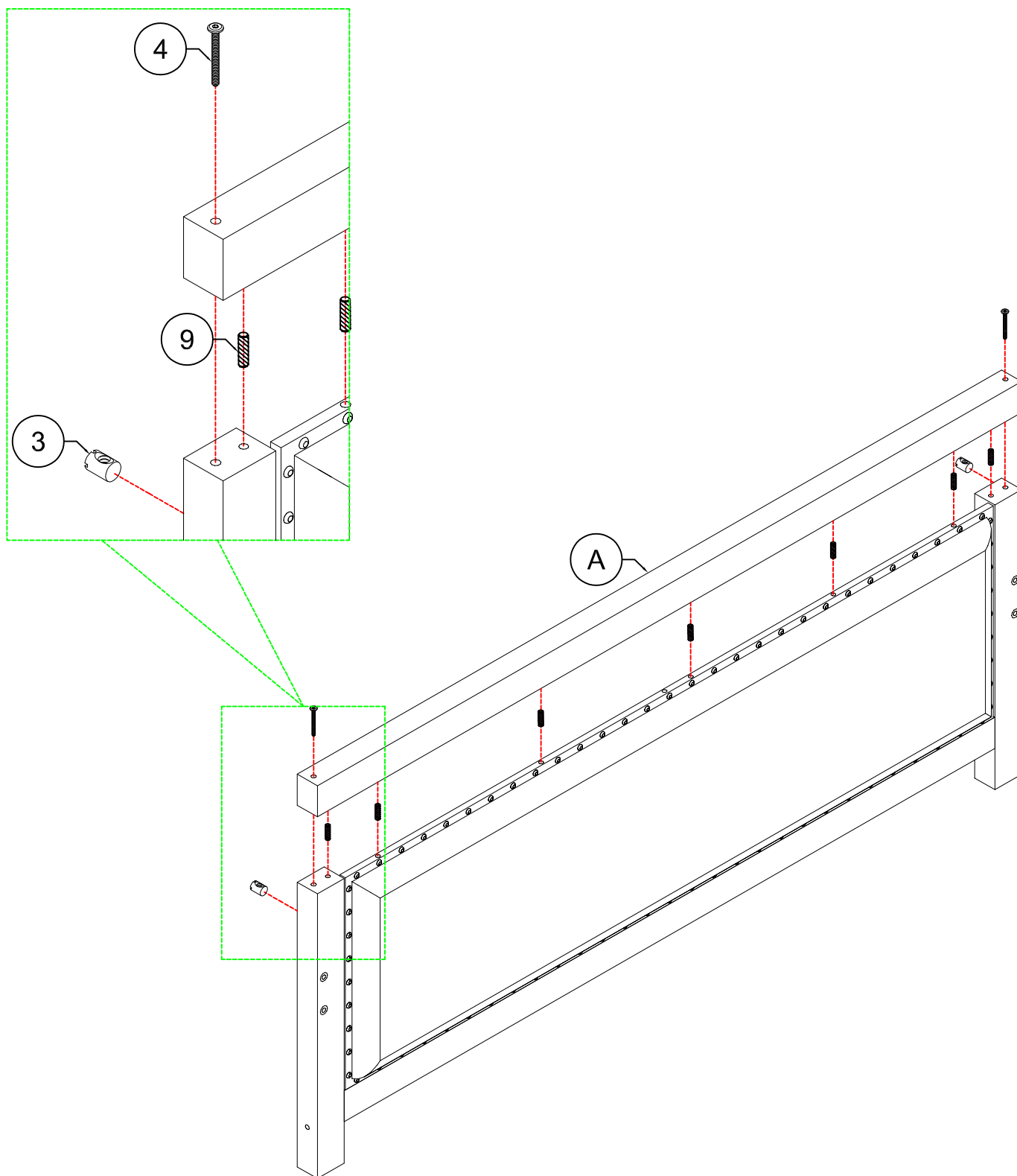
3	4	9
		
2pcs	2pcs	7pcs



STEP 8: Following below illustration:

8	11
	
10pcs	20pcs

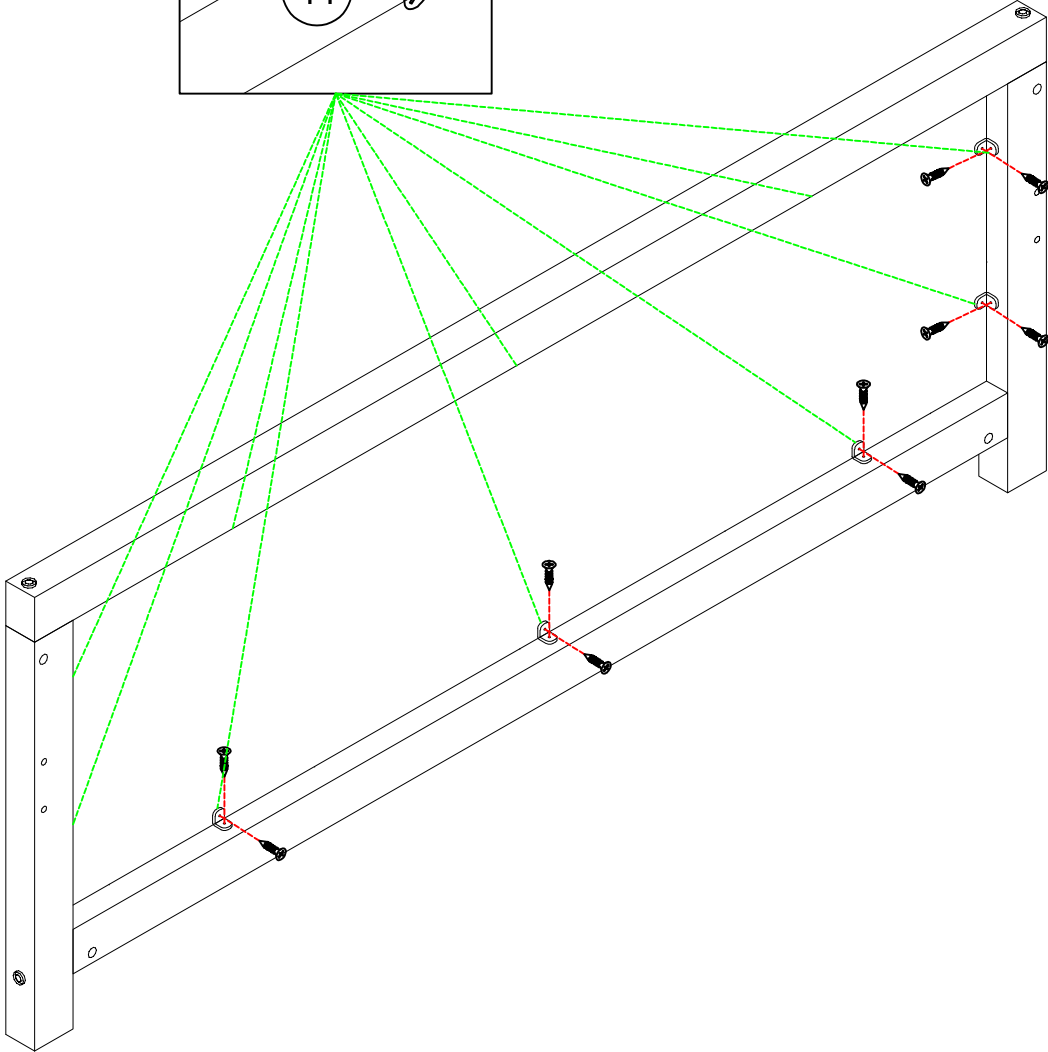
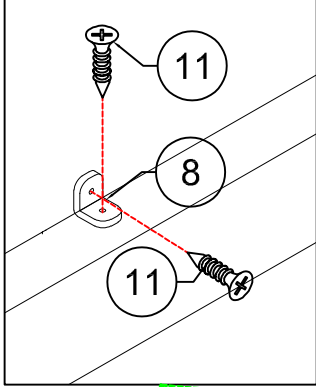

STEP 9: Following below illustration:

3	5	7	11
8pcs	8pcs	8pcs	8pcs

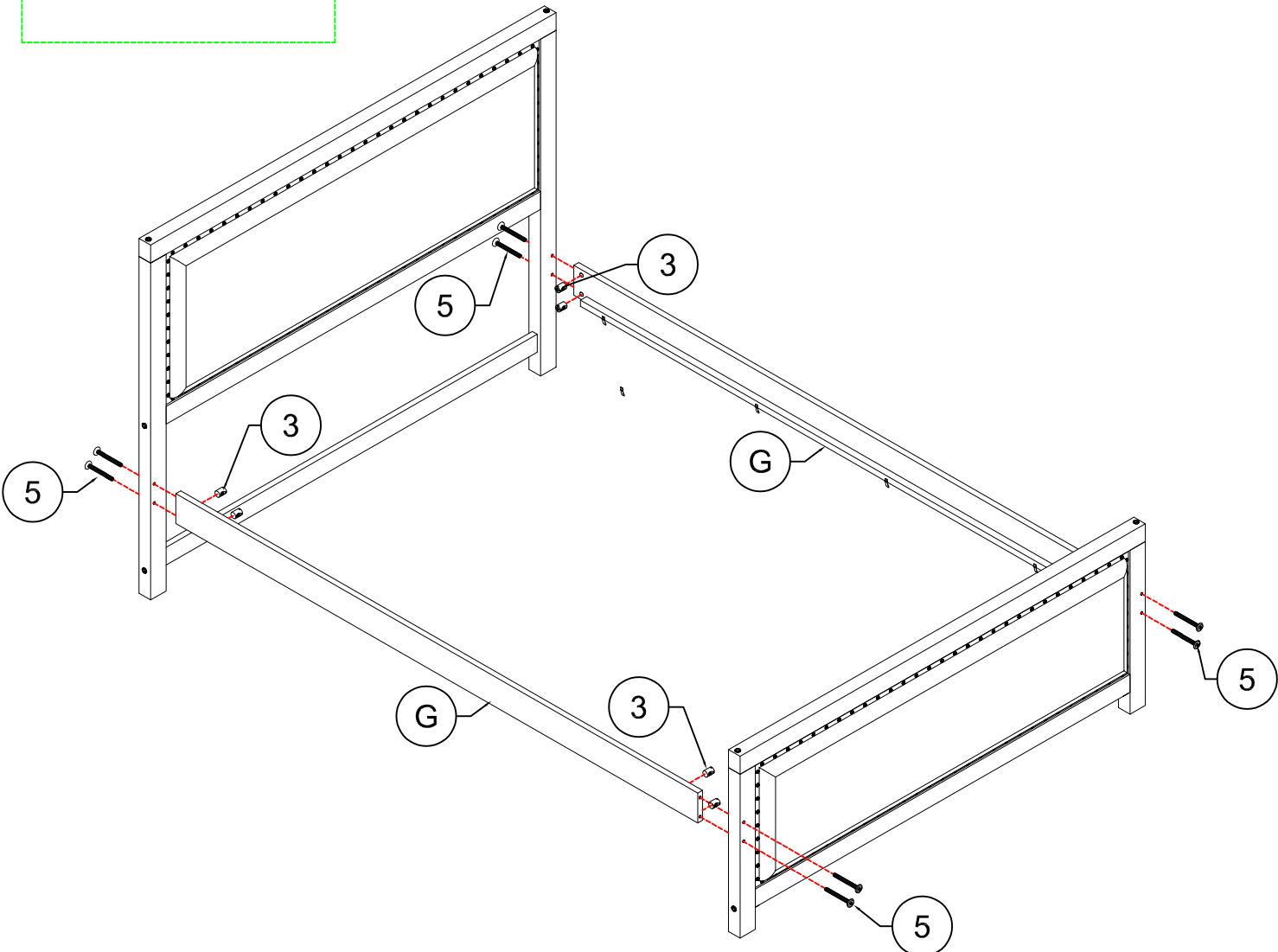
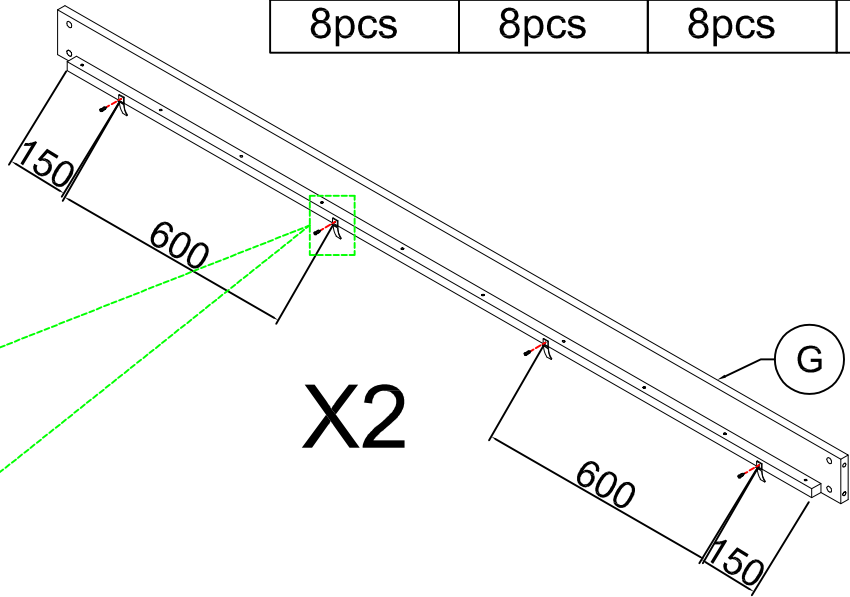
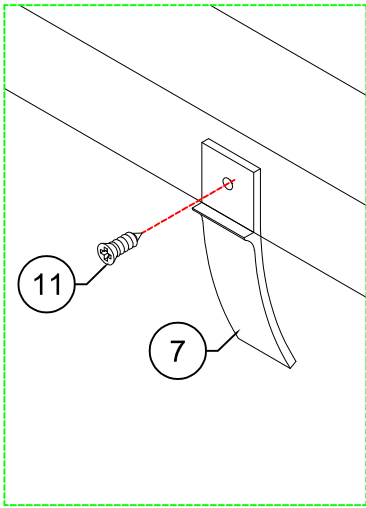

STEP 10: Following below illustration:

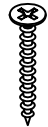
6	10
	
3pcs	6pcs

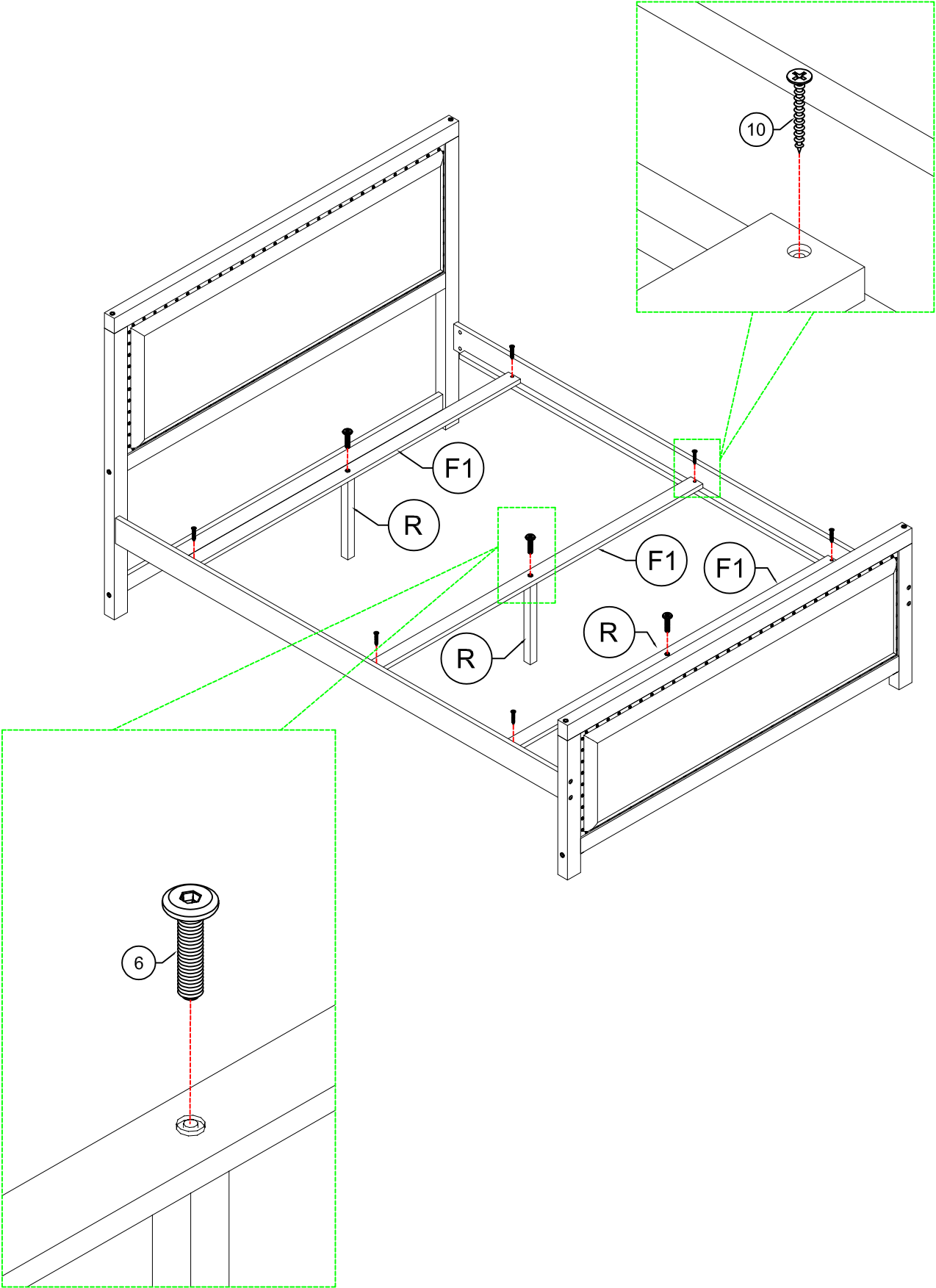

STEP 11: Following below illustration:



10

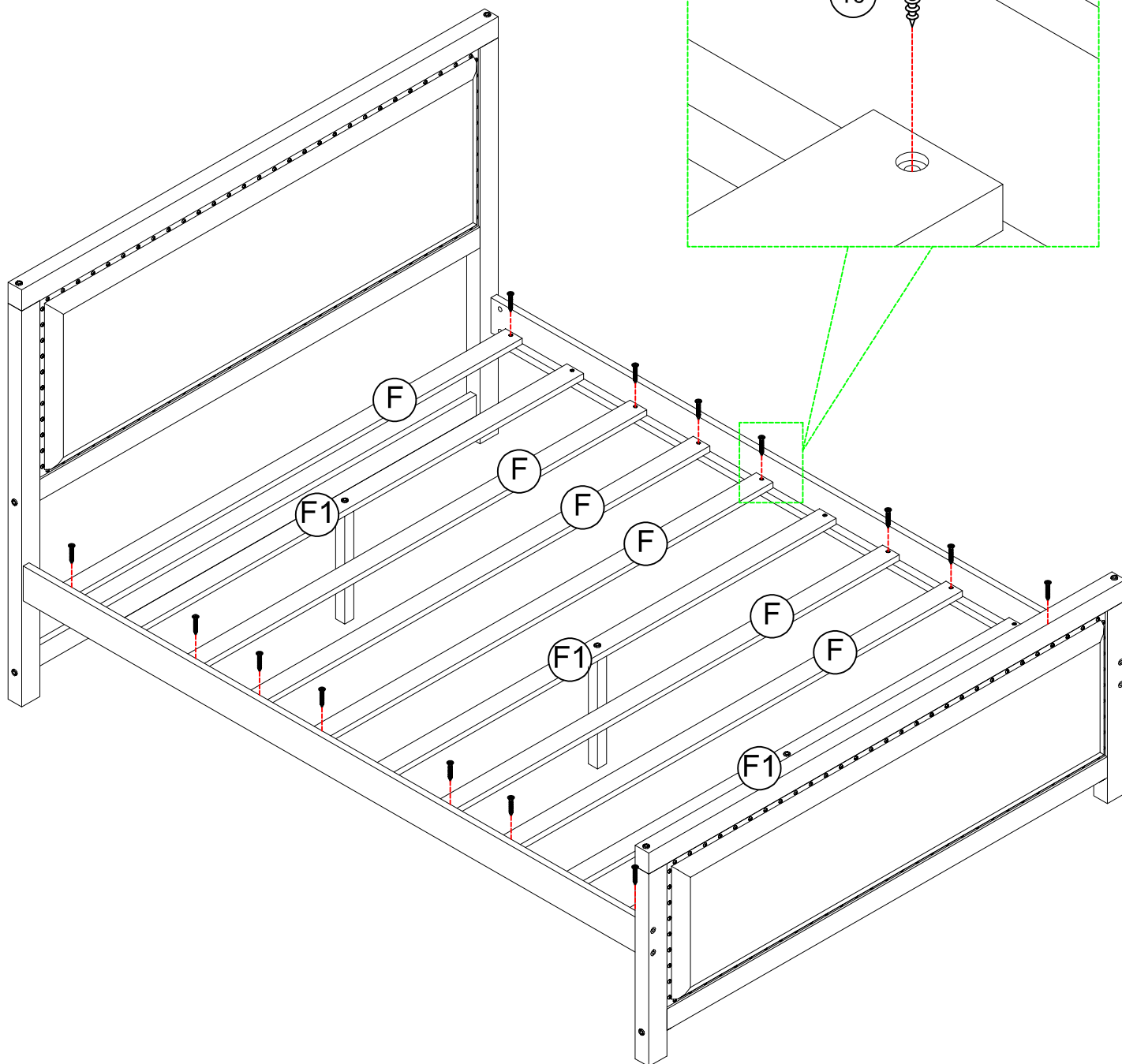

14pcs



STEP 12: Following below illustration:

12		13	
16pcs		16pcs	

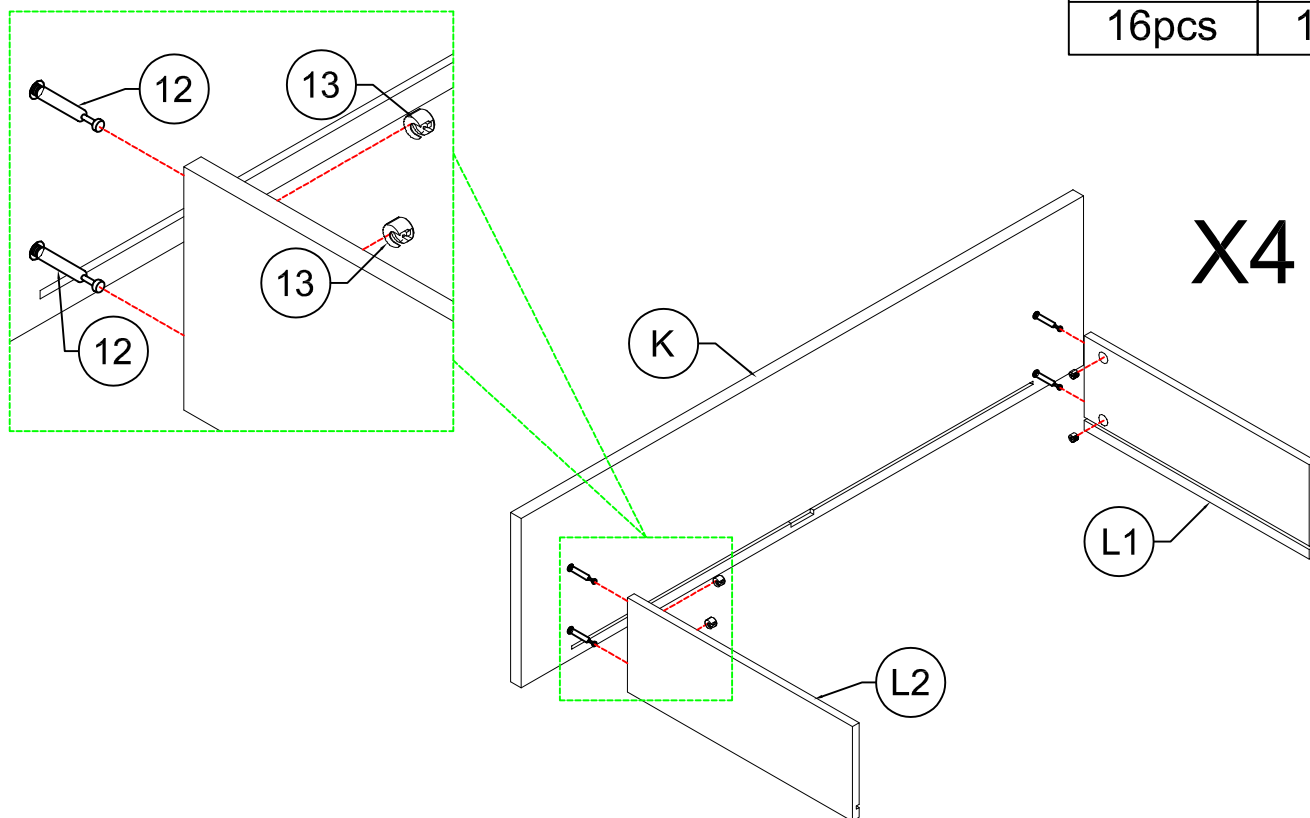

STEP 12-1: Following below illustration:

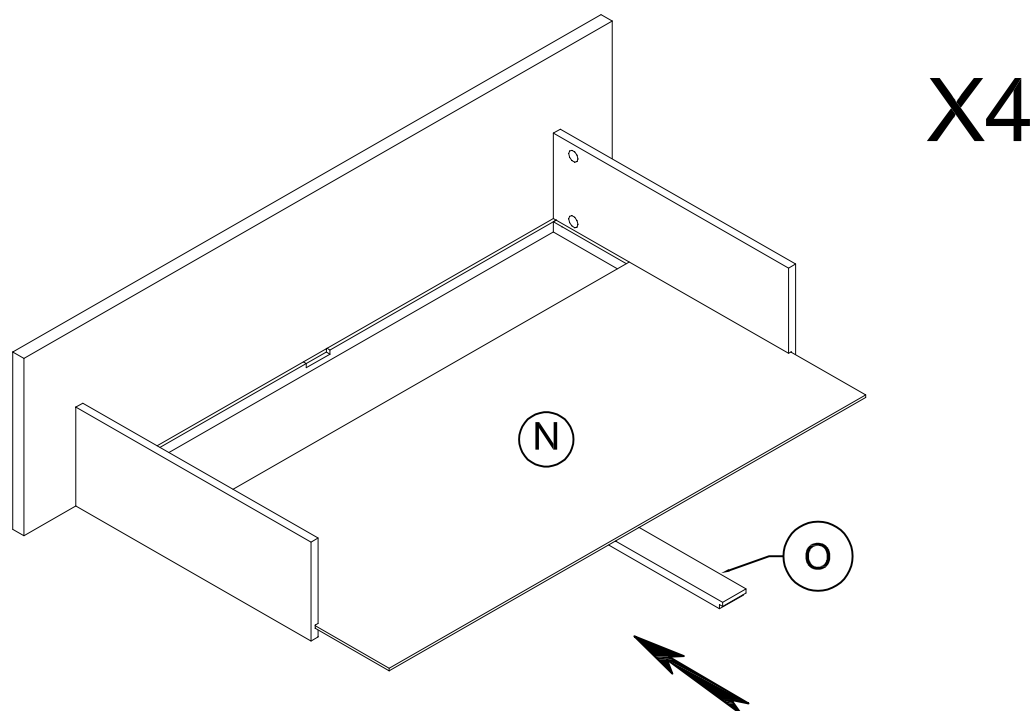

STEP 12-2: Following below illustration:

10	
16pcs	

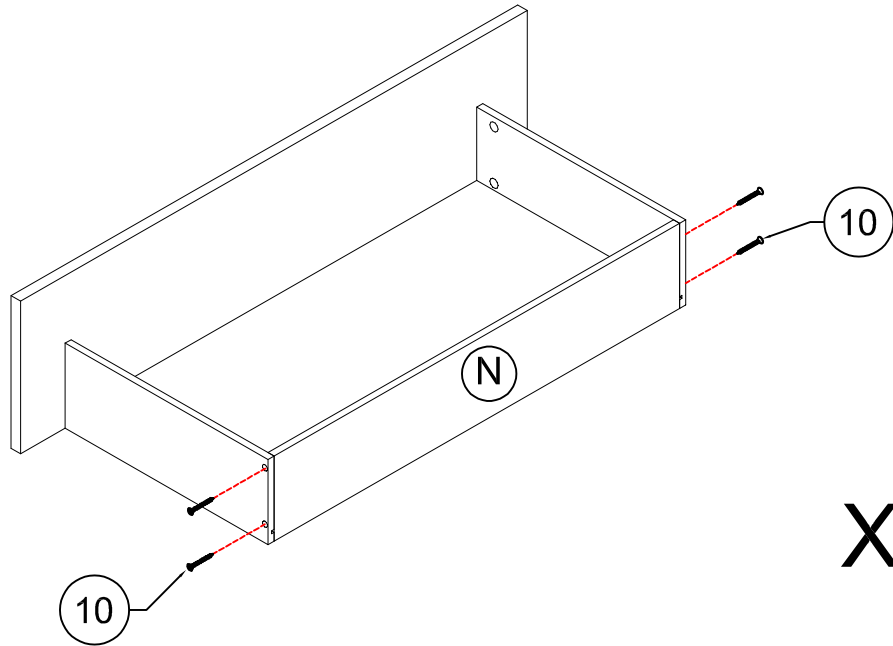

X4

STEP 12-3: Following below illustration:

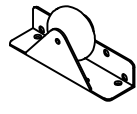
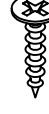
1	11
	
16pcs	32pcs

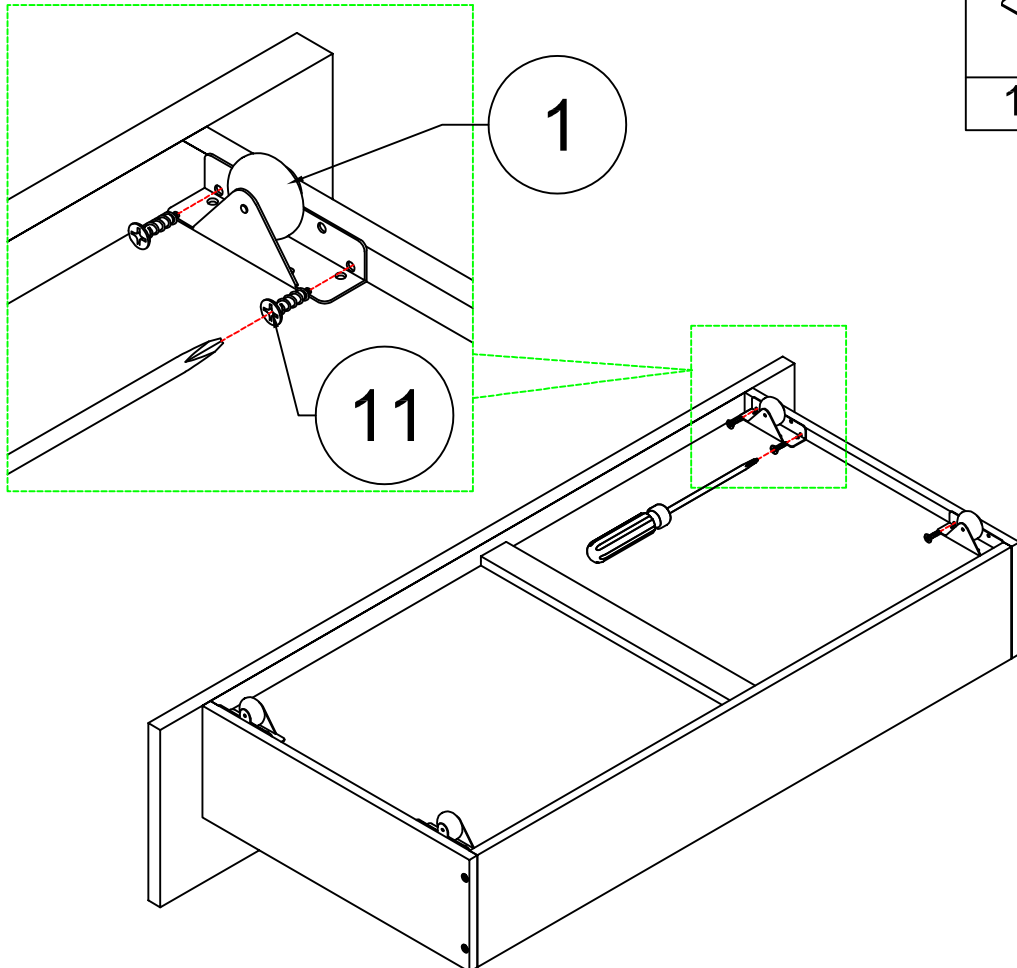

X4

FINISH

