

Screen Mount for 32" - 55" Monitor

32 et 55 de l'ordre du jour». Contrôle d'écrans pendre

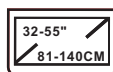

Max 800*400

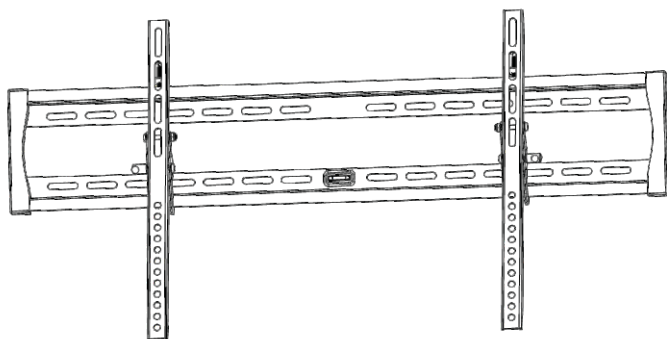













**User manuel included
Manuel d'utilisation inclus**



WARNING

1. Do not begin to installation of the product on you have read and understand the instructions and warnings contained in this installation sheet. If you have any questions regarding any of the instruction or warning, Please contact your local distributor.
2. Please refer to manufacture' s installation guide recommendation for required distance from wall to avoid risk of property damage.
3. This product should only be installed by someone of good mechanical aptitude, with experience and basic building, and fully understands.
4. Make sure that the supporting surface will safely support the combined load of the equipment and all attached hardware an components.
5. Never exceed the Maximum Load Capacity.
6. If mounting to wood wall studs ,make sure that mounting screws are anchored into the center of the studs Use of an " edge to edge" stud finder is highly recommended.
7. This product intended for indoor use only. Use of this product outdoors could lead to product failure and personal injury.
8. The thickness of the plaster and paint on the wall should not exceed 5 mm. Make sure that the wall does not pass the cable or other wires.

<p>A</p>  <p>M5X16 4PCS</p>	<p>B</p>  <p>M5X30 4PCS</p>	<p>C</p>  <p>M6X16 4PCS</p>	<p>D</p>  <p>M6X30 4PCS</p>	<p>E</p>  <p>M8X16 4PCS</p>	<p>F</p>  <p>M8X30 4PCS</p>
<p>G</p>  <p>St8X50 6PCS</p>	<p>H</p>  <p>10X40 6PCS</p>	<p>I</p>  <p>3 holes 4PCS</p>	<p>J</p>  <p>$\Phi 8.5 \times 18 \times 1.5$ 6PCS</p>	<p>K</p>  <p>$\Phi 8.5 \times 18 \times 1.5$ 4PCS</p>	<p>L</p>  <p>Plate 1PCS</p>
<p>M</p>  <p>TV Arm 2PCS</p>					

Steps of installation

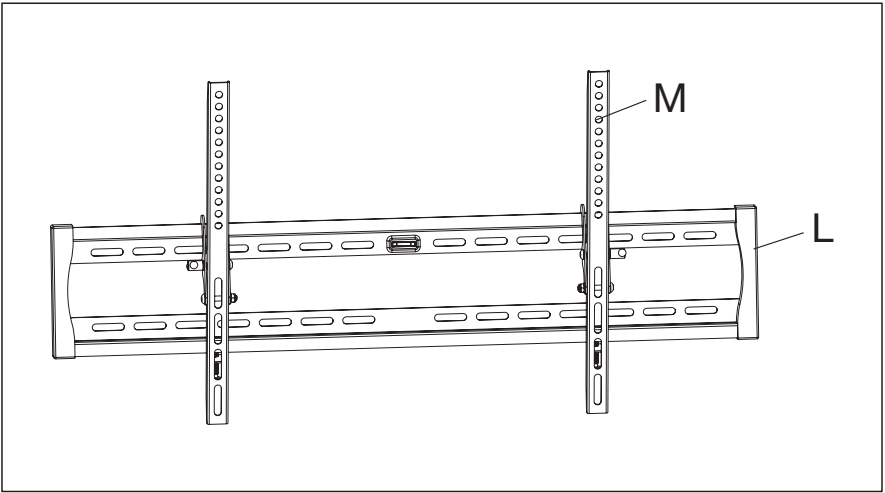

1

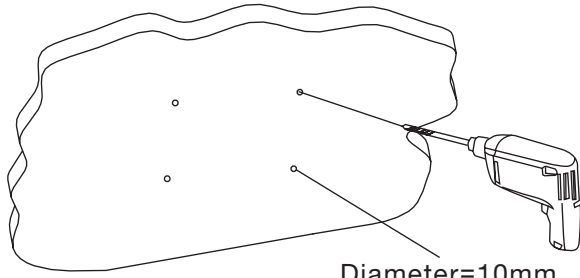

Diameter=10mm
Depth=50mm

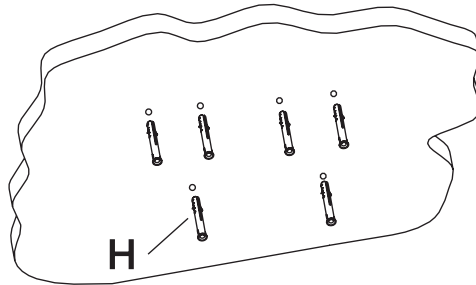

2

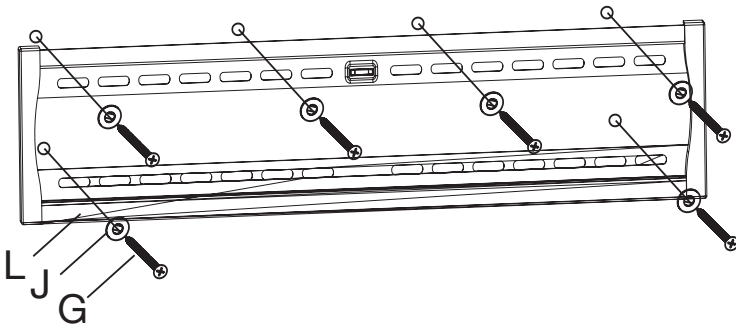

3

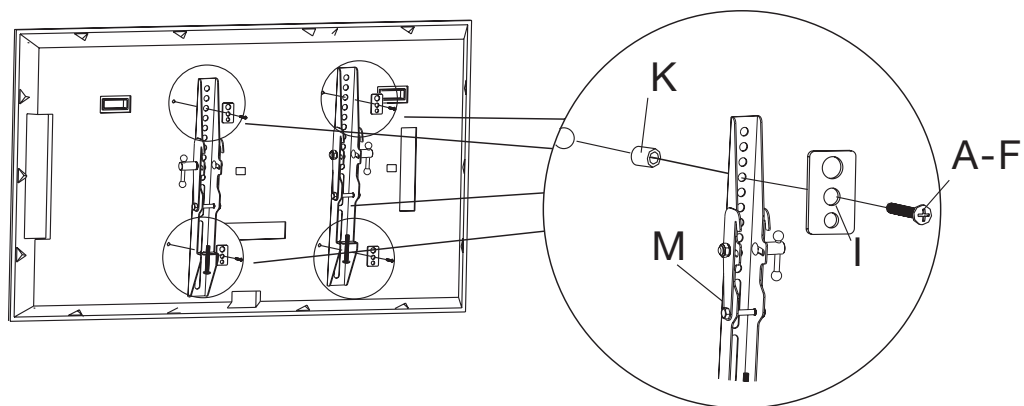

4

