





| | | | | | | | | | | | | | |
|---|-------|---|-------|---|-------|---|-----|--|-----|---|----|---|-----|
| ① | X8 | ② | X10 | ③ | X10 | ④ | X18 | ⑤ | X18 | ⑥ | X1 | ⑦ | X8 |
|  | M8*55 |  | M8*45 |  | M8*20 |  | M8 |  | M8 |  | 5# |  | φ20 |

step1



step2

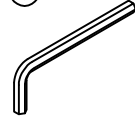
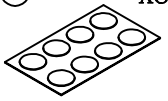
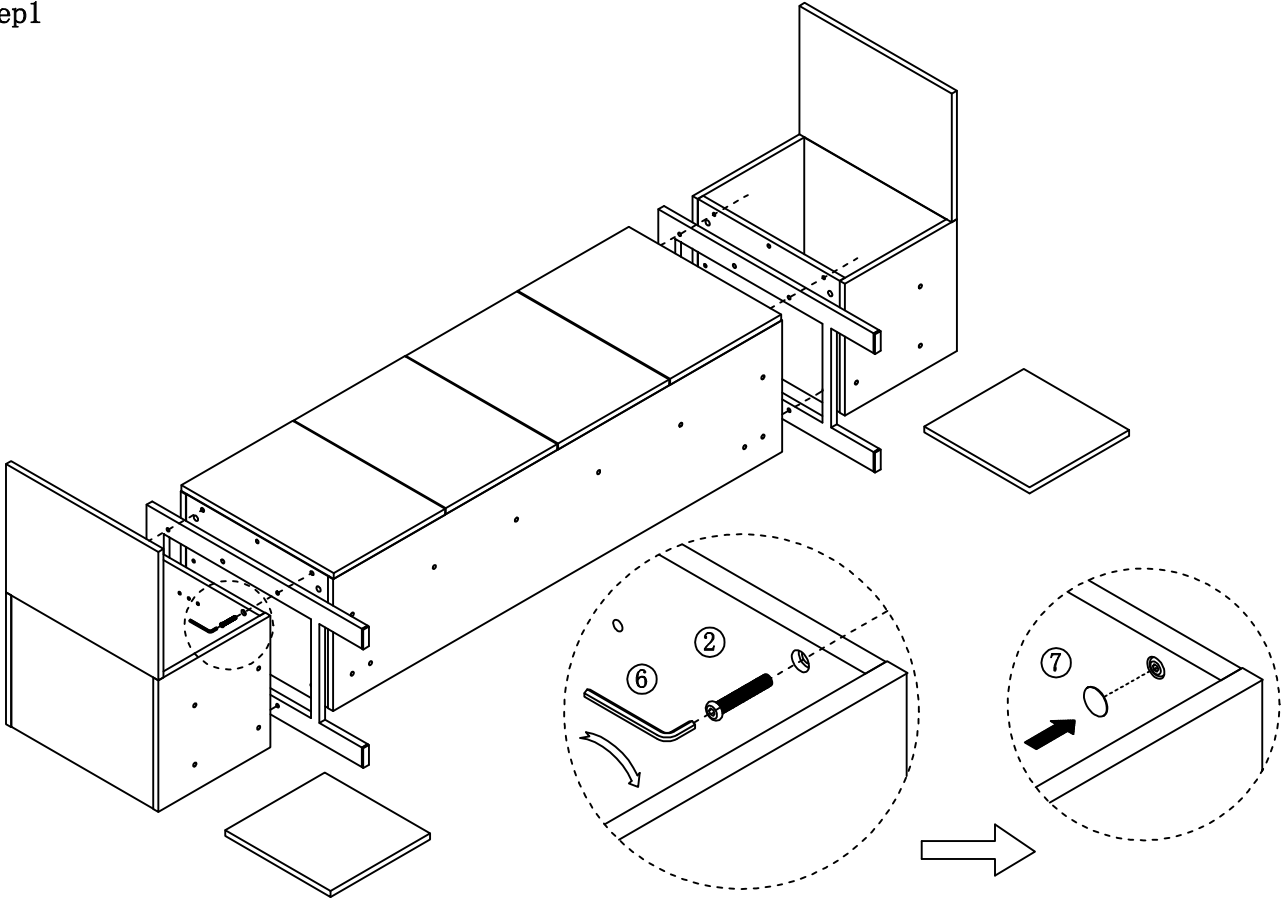