

0,5h

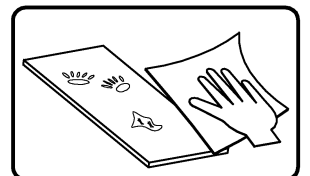

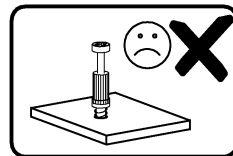

nr	L[mm]	B[mm]	T[mm]	Menge	Colli
1	920	770	19	1	1/2

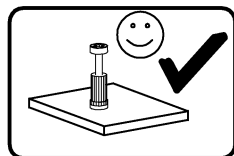
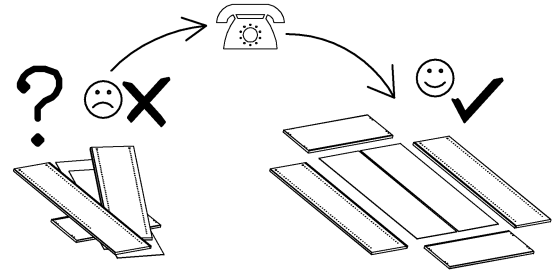
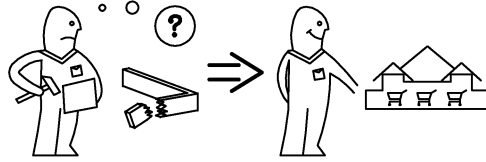
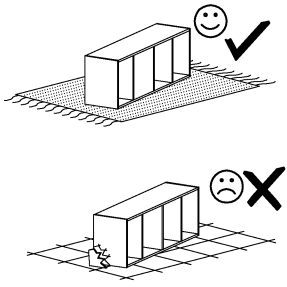
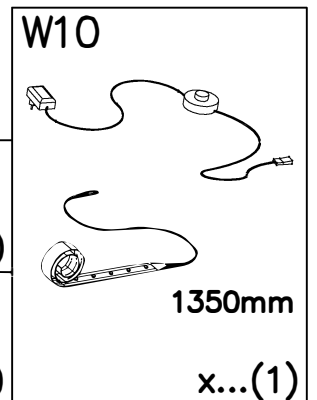
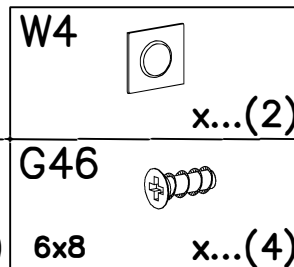
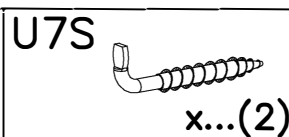
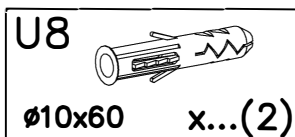
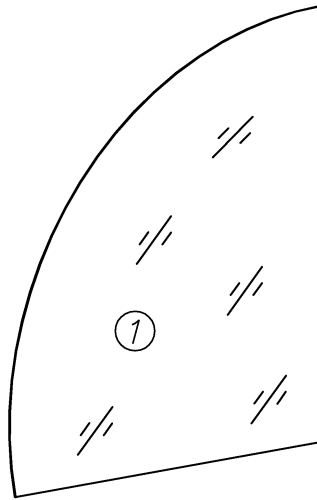



I



G46



6x8

x...(4)

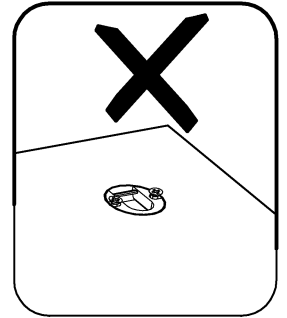
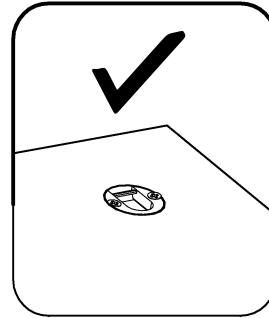
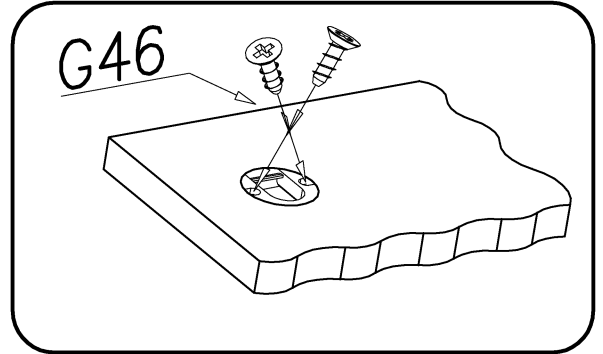
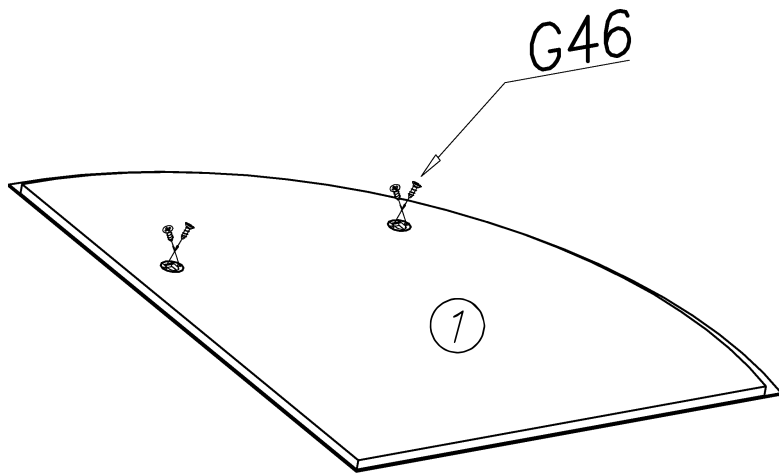

II

W4



2x

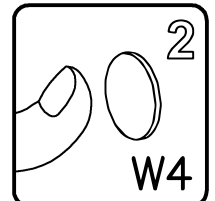
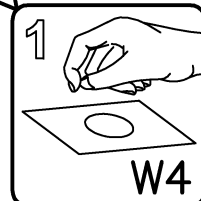
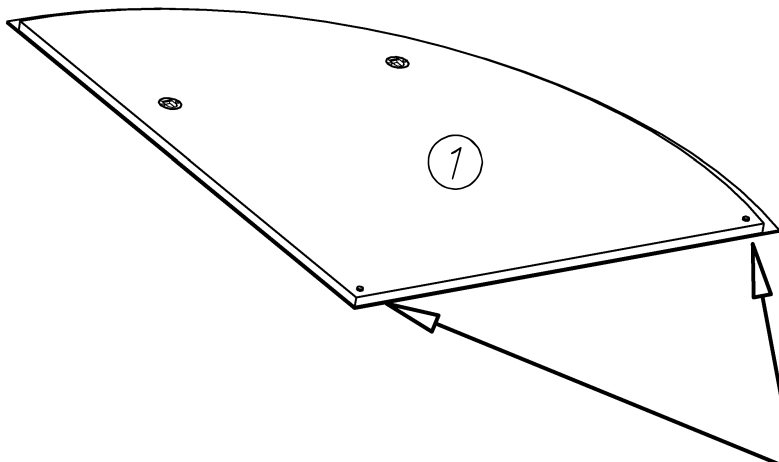



III

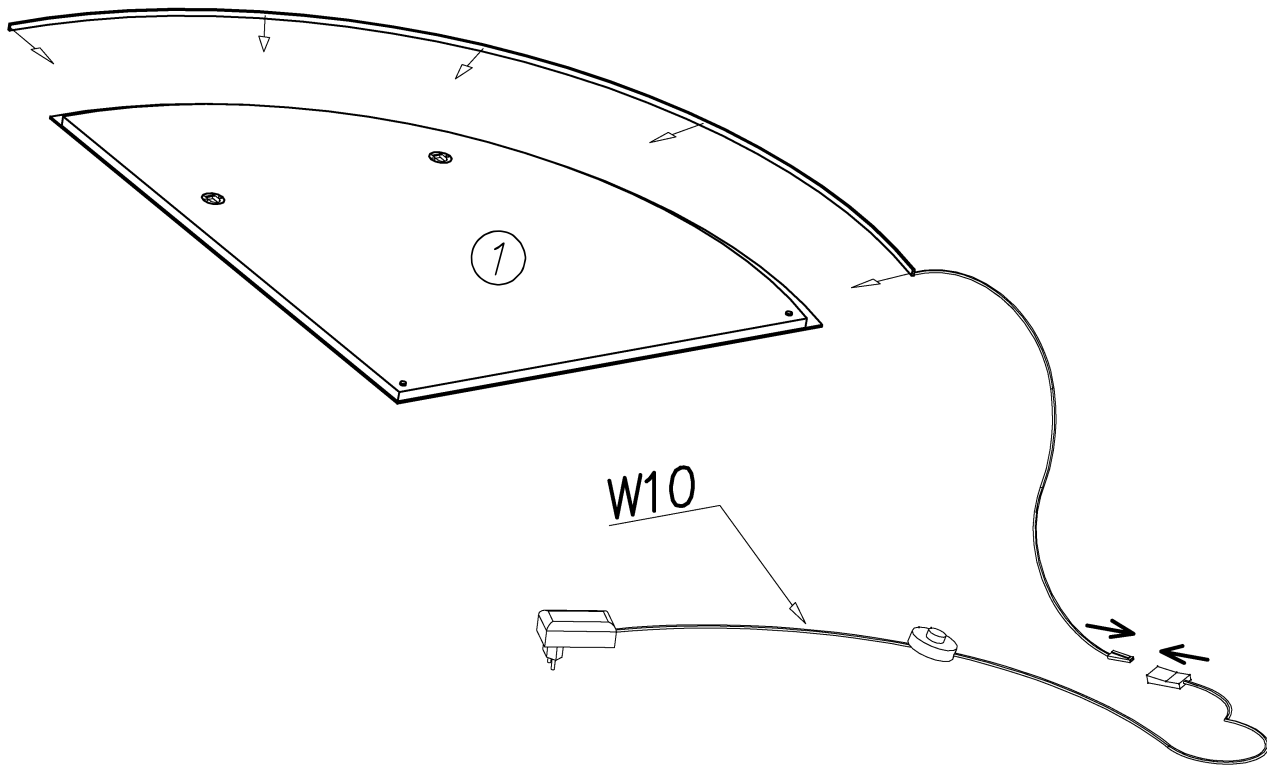
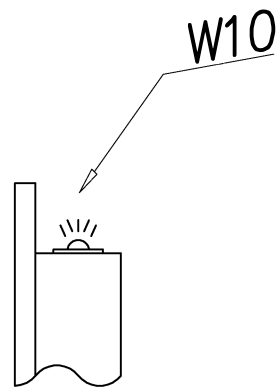
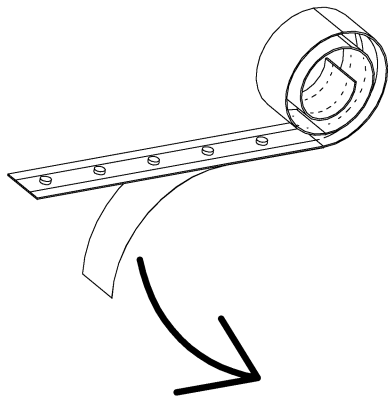



IV

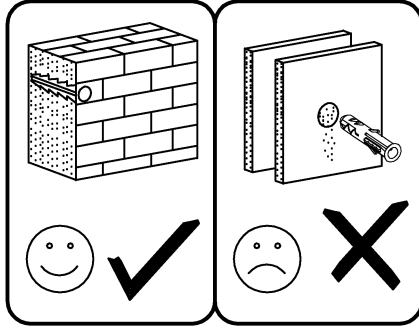

1

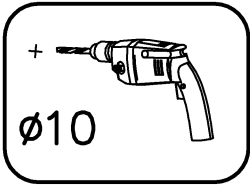

2

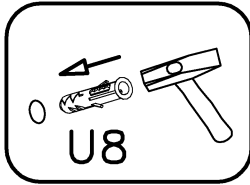

3

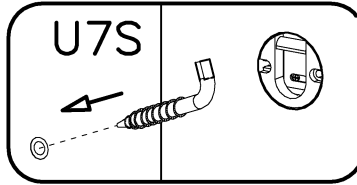

4

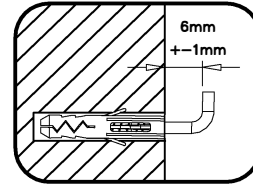

5

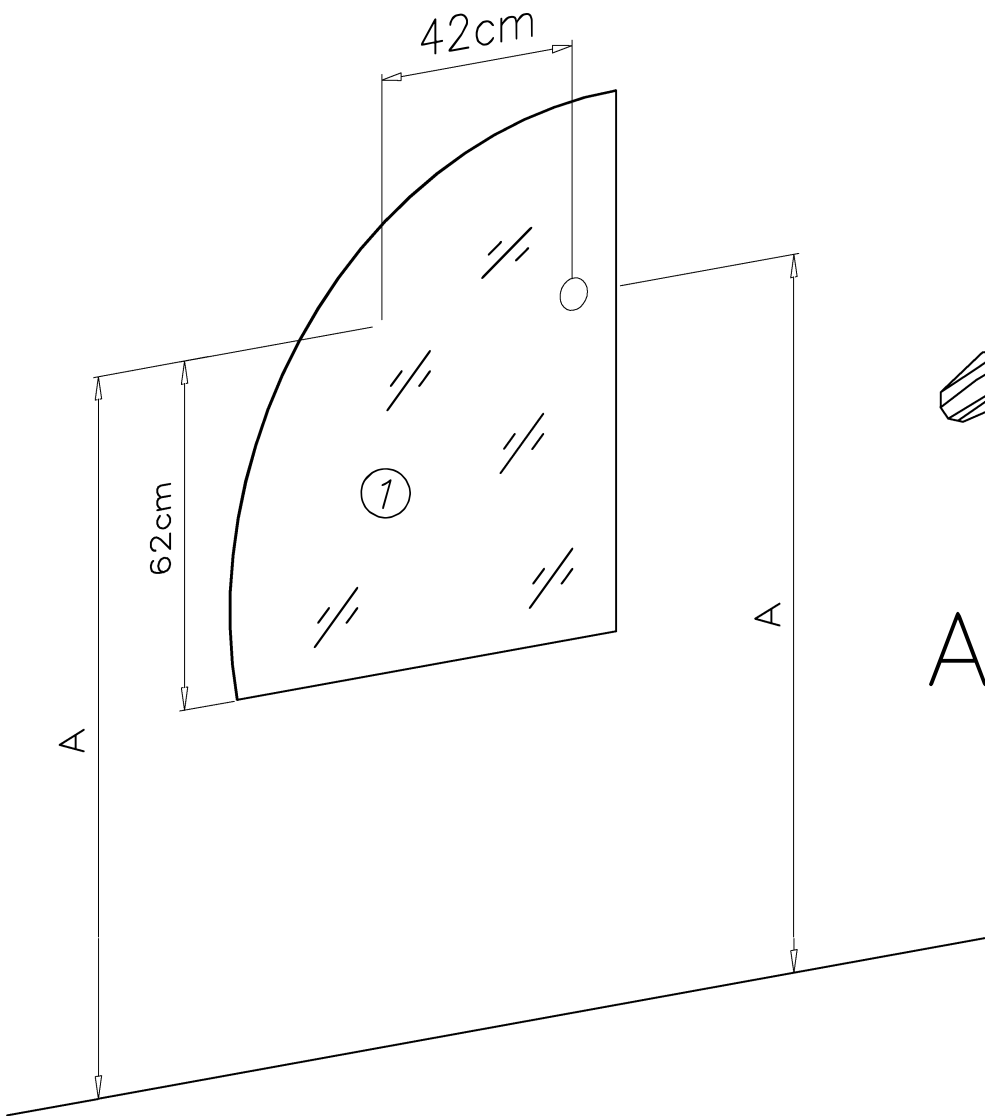
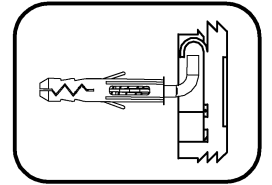

A = A

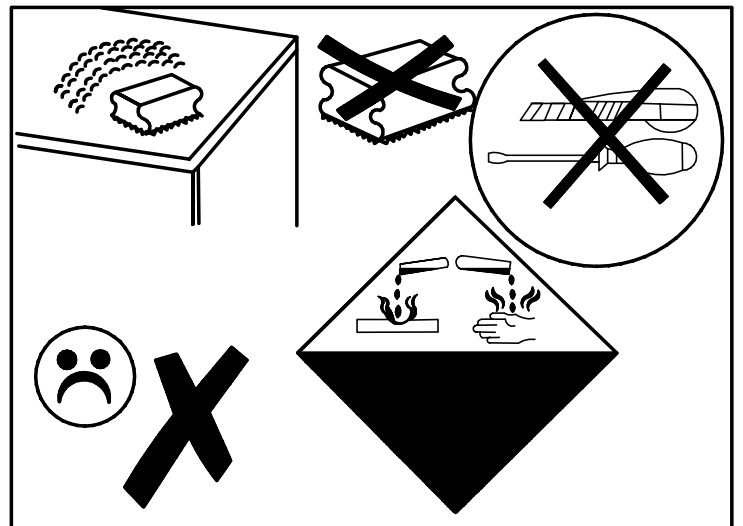
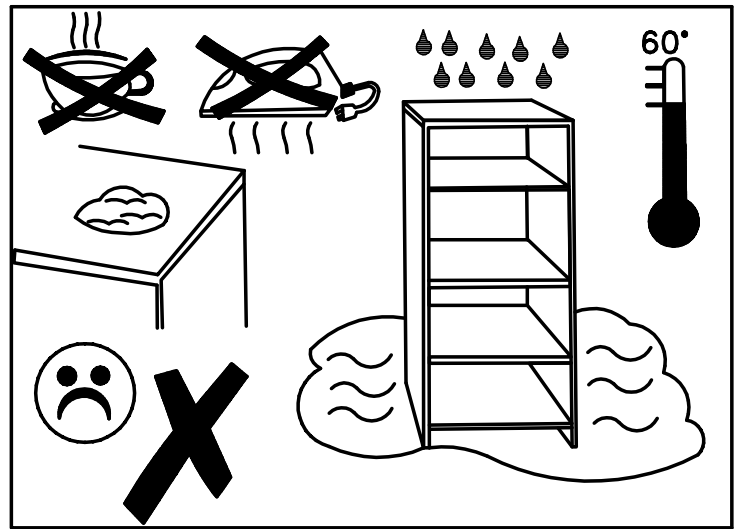
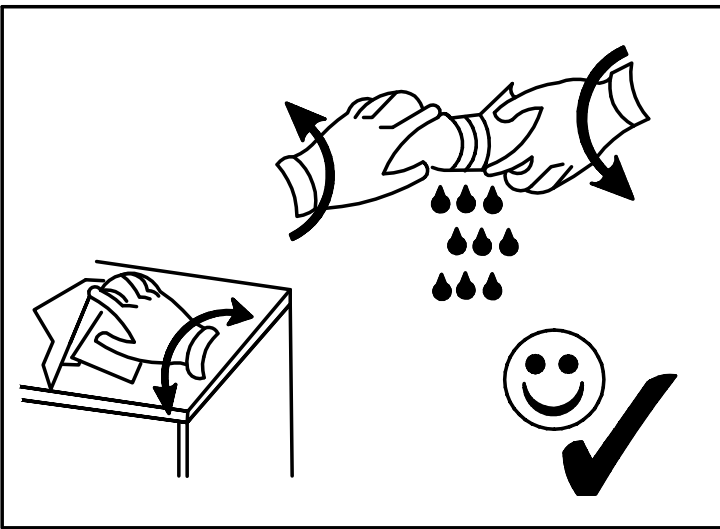
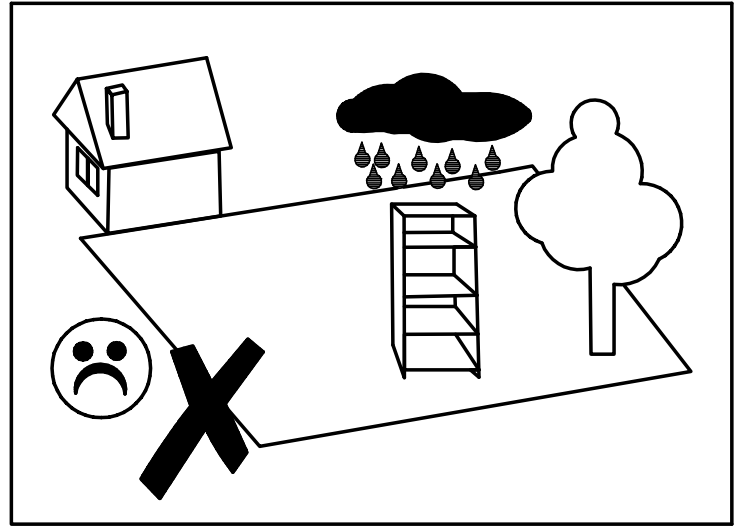
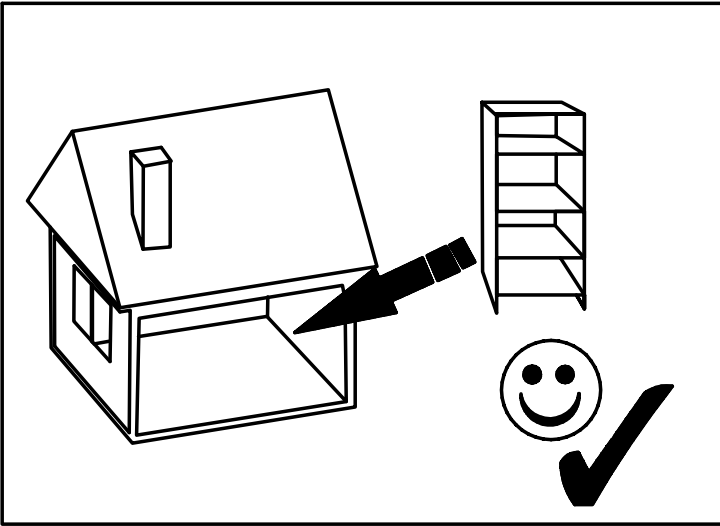

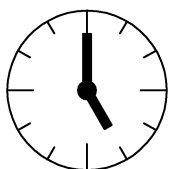
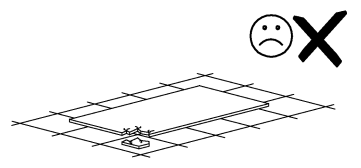
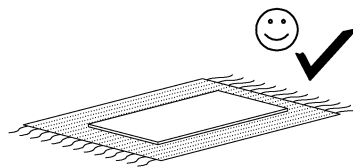
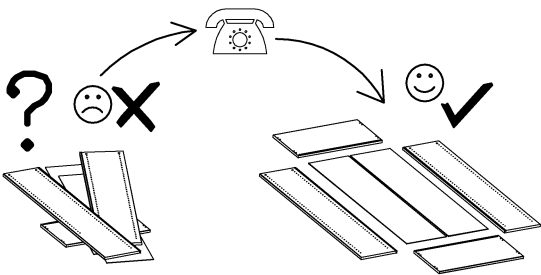
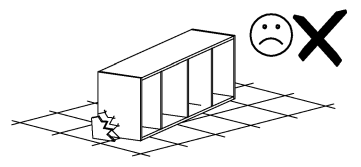
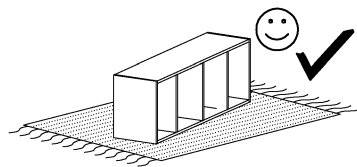
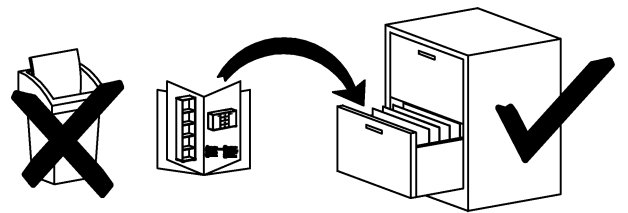
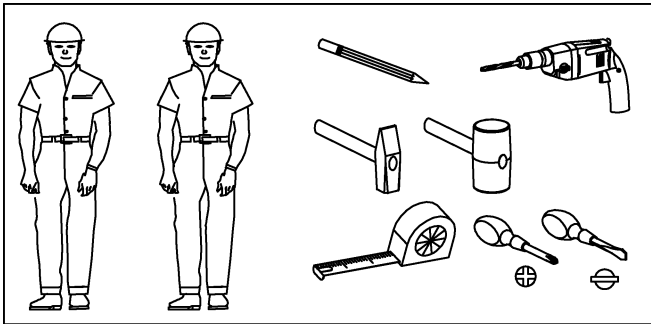

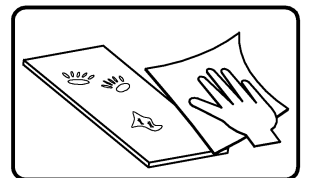
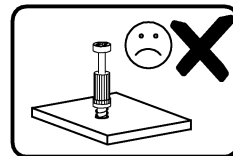
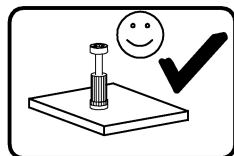

0,5h

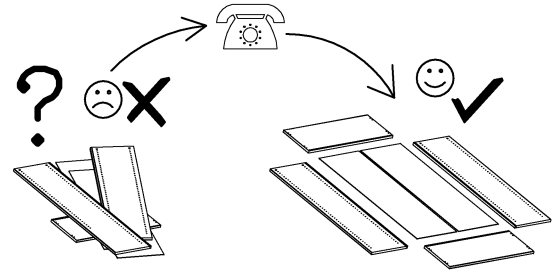
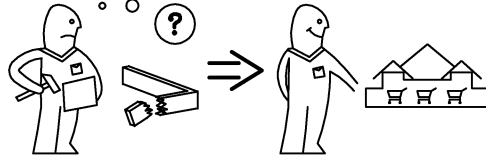
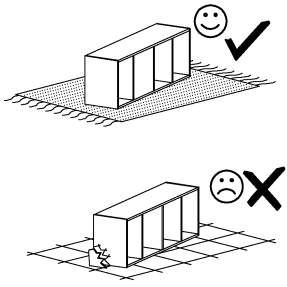



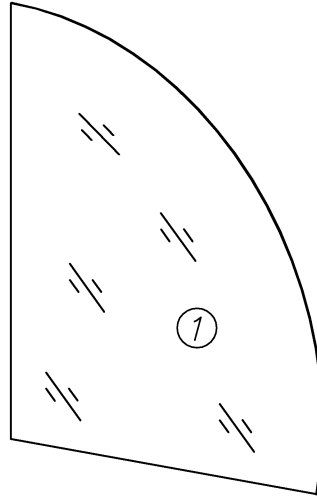

nr	L[mm]	B[mm]	T[mm]	Menge	Colli
1	920	770	19	1	1/2



U8 
 ø10x60 x...(2)

U7S 
 x...(2)

W4 
 x...(2)

G46 
 6x8 x...(4)

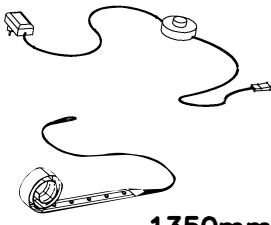
W10 
 1350mm
 x...(1)



I



G46



6x8

x...(4)

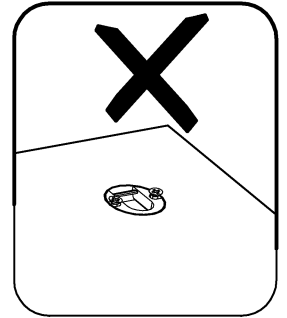
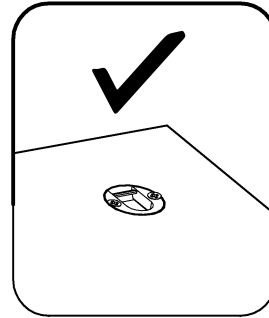
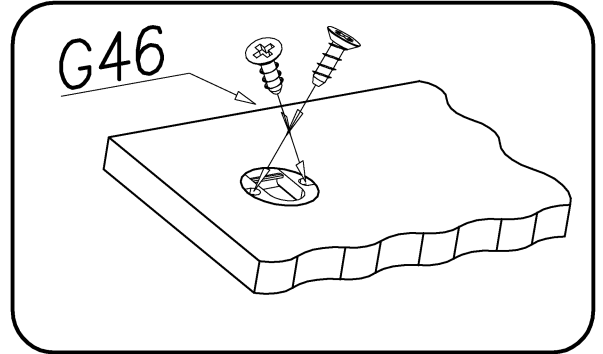
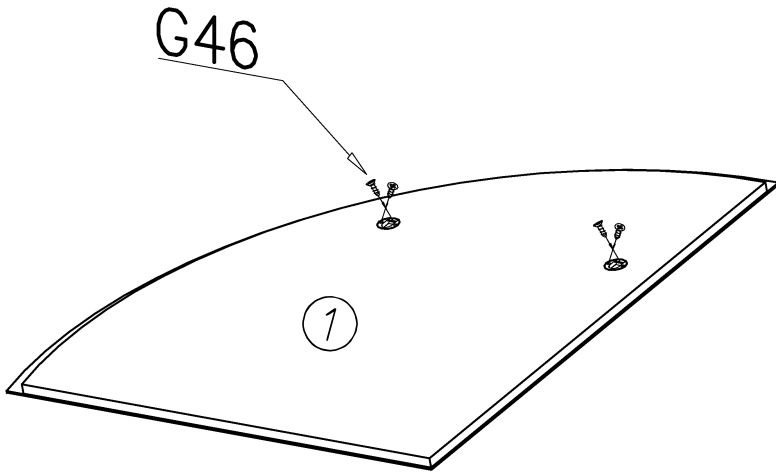

II

W4



2x

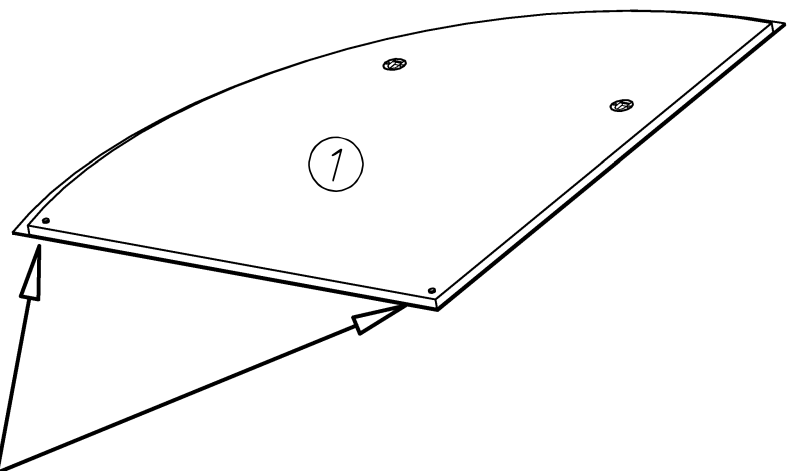
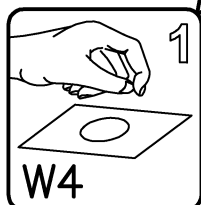
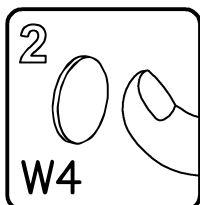



III

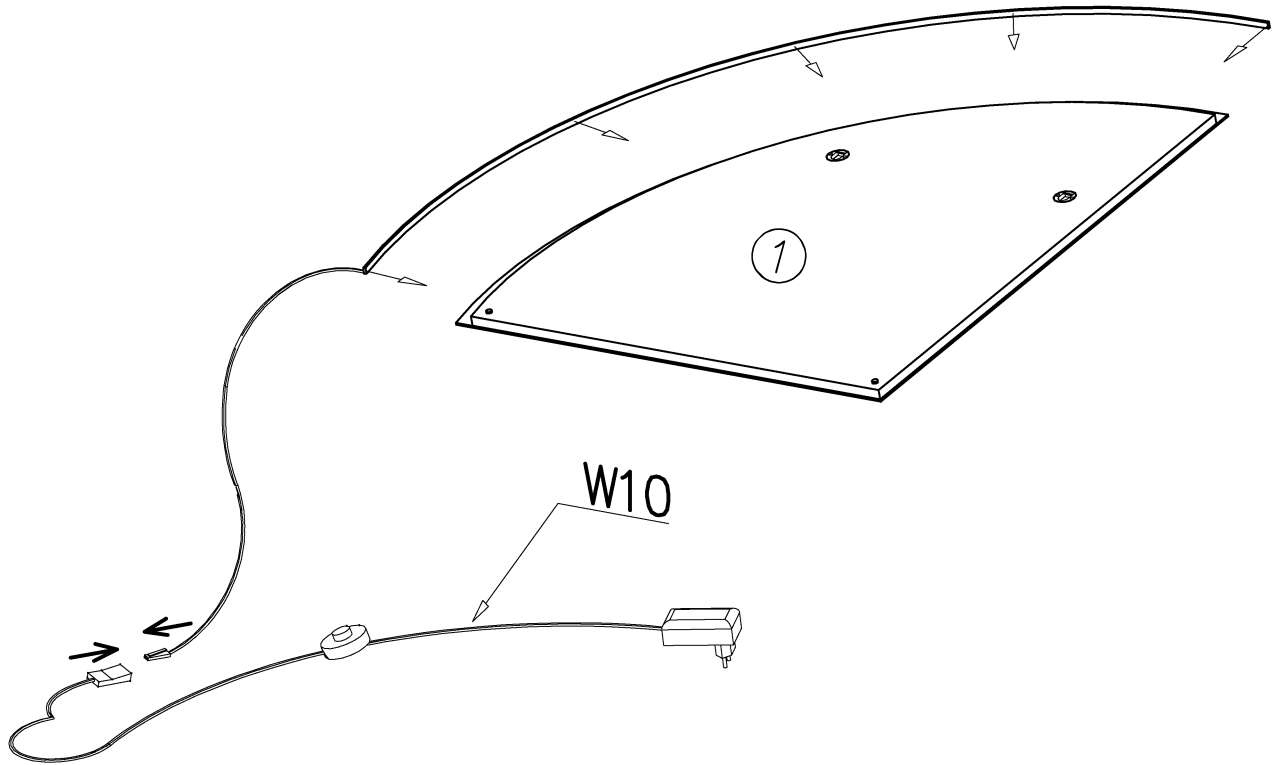
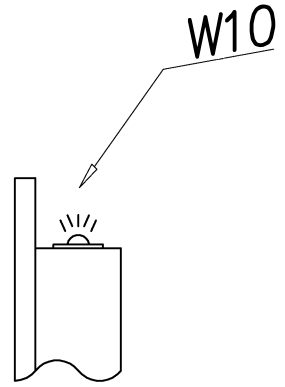
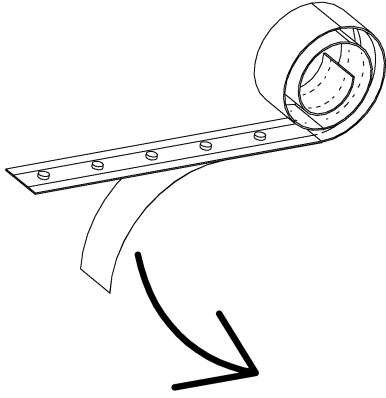



IV

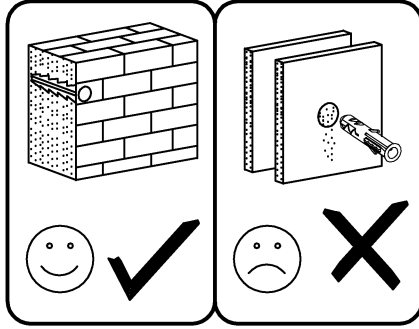

1

2

3

4

5

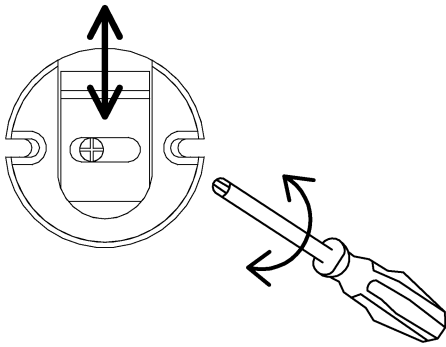
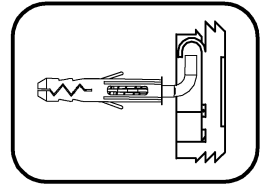
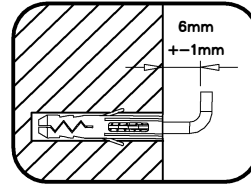
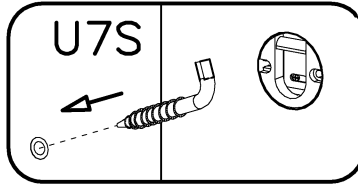
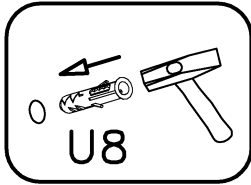
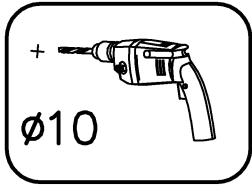

A = A

