

**10-DRAWER STORAGE CHEST**  
**AUFBEWAHRUNGSKOMMODE MIT 10 SCHUBLADEN**  
**ARMOIRE DE RANGEMENT AVEC 10 TIROIRS**  
**10-CASSETTO PORTAGGETTI**  
**CÓMODA DE 10 CAJONES**



**Attention:** Do not tighten the screws until you have completed the assembly.

1. Please be aware that the drawer storage towers are lightweight, so pulling them down could be dangerous, especially when children are playing and chasing each other around the drawers.
2. Professional installation is highly recommended.

**Achtung:** Ziehen Sie die Schrauben erst an, wenn Sie den Aufbau abgeschlossen haben.

1. Bitte beachten Sie, dass die Lagertürme mit Schubladen sehr leicht sind, so dass sie einfach heruntergezogen werden können, wodurch Gefahren verursacht werden, insbesondere wenn Kinder damit spielen und sich herumjagen.
2. Ein fachgerechter Einbau wird dringend empfohlen.

**Remarque:** Ne serrez pas les vis avant d'avoir terminé l'assemblage.



1. Veuillez noter que les tours de rangement des tiroirs sont légères, il peut donc être dangereux de les abaisser, surtout lorsque les enfants jouent et se poursuivent autour des tiroirs.
2. Une installation professionnelle est fortement recommandée.





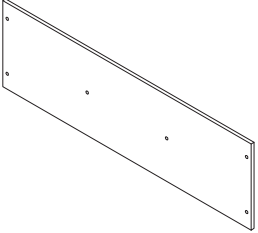
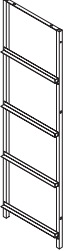
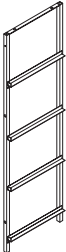

**Attenzione:** Non serrare le viti fino a quando non si è completato il montaggio dell'installazione.

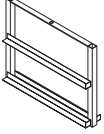
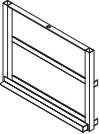
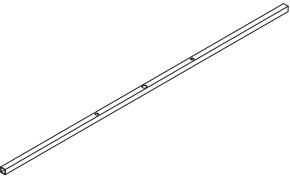
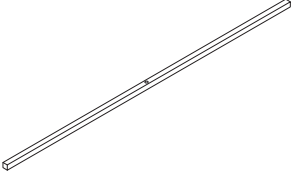
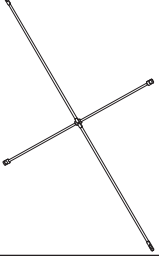
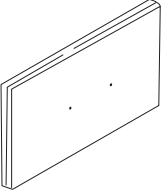
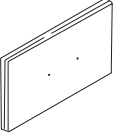
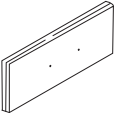
1. Tenere presente che le torri di stoccaggio dei cassetti sono leggere, quindi tirarle verso il basso potrebbe essere pericoloso, specialmente quando i bambini giocano e si rincorrono intorno ai cassetti.
2. Si consiglia vivamente un'installazione professionale.

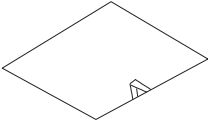
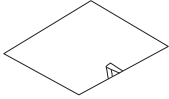
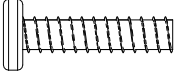
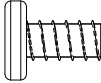
**Atención:** No apriete los tornillos hasta que haya completado el montaje de la configuración.

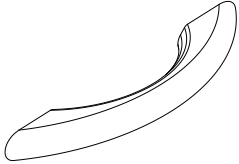
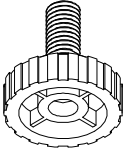
1. Tenga en cuenta que las torres de cajones son ligeras, por lo que puede ser peligroso bajarlas, especialmente cuando los niños juegan y persiguen alrededor de los cajones.
2. Se recomienda encarecidamente la instalación profesional.

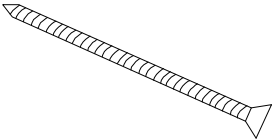
Item no. Nr. N° d'article Articolo No. Artículo No.	Reference Image Referenzbild Image de référence Immagine di riferimento Imagen de referencia	Qty. Menge Qté. Qtà Cant.	Item no. Nr. N° d'article Articolo No. Artículo No.	Reference Image Referenzbild Image de référence Immagine di riferimento Imagen de referencia	Qty. Menge Qté. Qtà Cant.
1		X1	2		X1
3		X1	4		X1
5		X1	6		X1
7		X2	8		X2
9		X2	10		X6
11		X2	12		X2

Item no. Nr. N° d'article Articolo No. Artículo No.	Reference Image Referenzbild Image de référence Immagine di riferimento Imagen de referencia	Qty. Menge Qté. Qtà Cant.	Item no. Nr. N° d'article Articolo No. Artículo No.	Reference Image Referenzbild Image de référence Immagine di riferimento Imagen de referencia	Qty. Menge Qté. Qtà Cant.
<b>13</b>		<b>X6</b>	<b>14</b>		<b>X4</b>
<b>A</b>	 M6X30mm	<b>X16</b>	<b>B</b>	 M6X10mm	<b>X12</b>
<b>C</b>	 M4X10mm	<b>X20</b>	<b>D</b>		<b>X10</b>
<b>E</b>	 M6X28mm	<b>X4</b>	<b>F</b>		<b>X2</b>
<b>G</b>	 M4X60mm	<b>X2</b>	<b>H</b>		<b>X1</b>

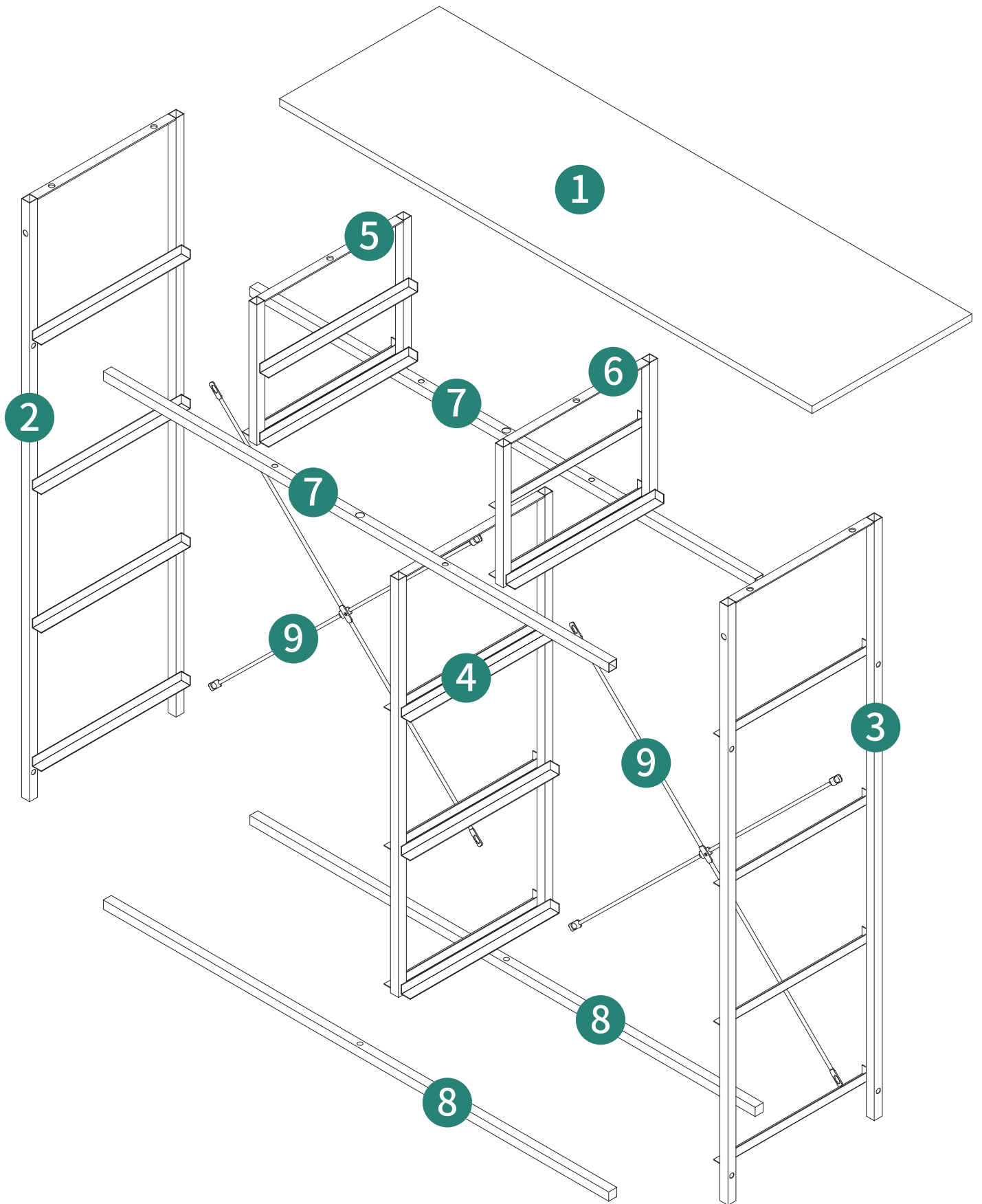

# 1

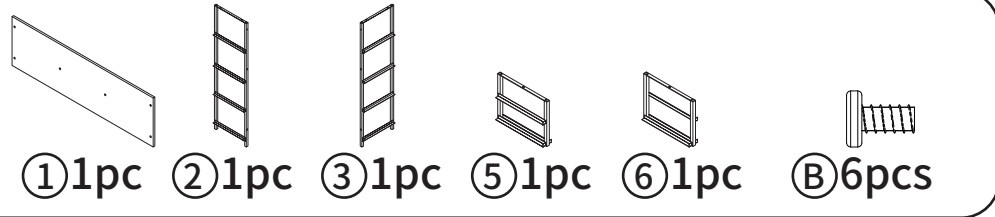

Please make sure that the iron frames are placed in the correct position and facing the correct direction.  
Bitte vergewissern Sie sich, dass die Eisenrahmen gut aufgestellt sind und in die richtige Richtung zeigen.  
Veuillez vous assurer que les cadres en fer sont placés dans la bonne position et dans la bonne direction.  
Assicurarsi che i telai di ferro siano posizionati nella posizione corretta e rivolti nella direzione corretta.  
Asegúrese de que los marcos de hierro están en la posición correcta y en la dirección correcta.

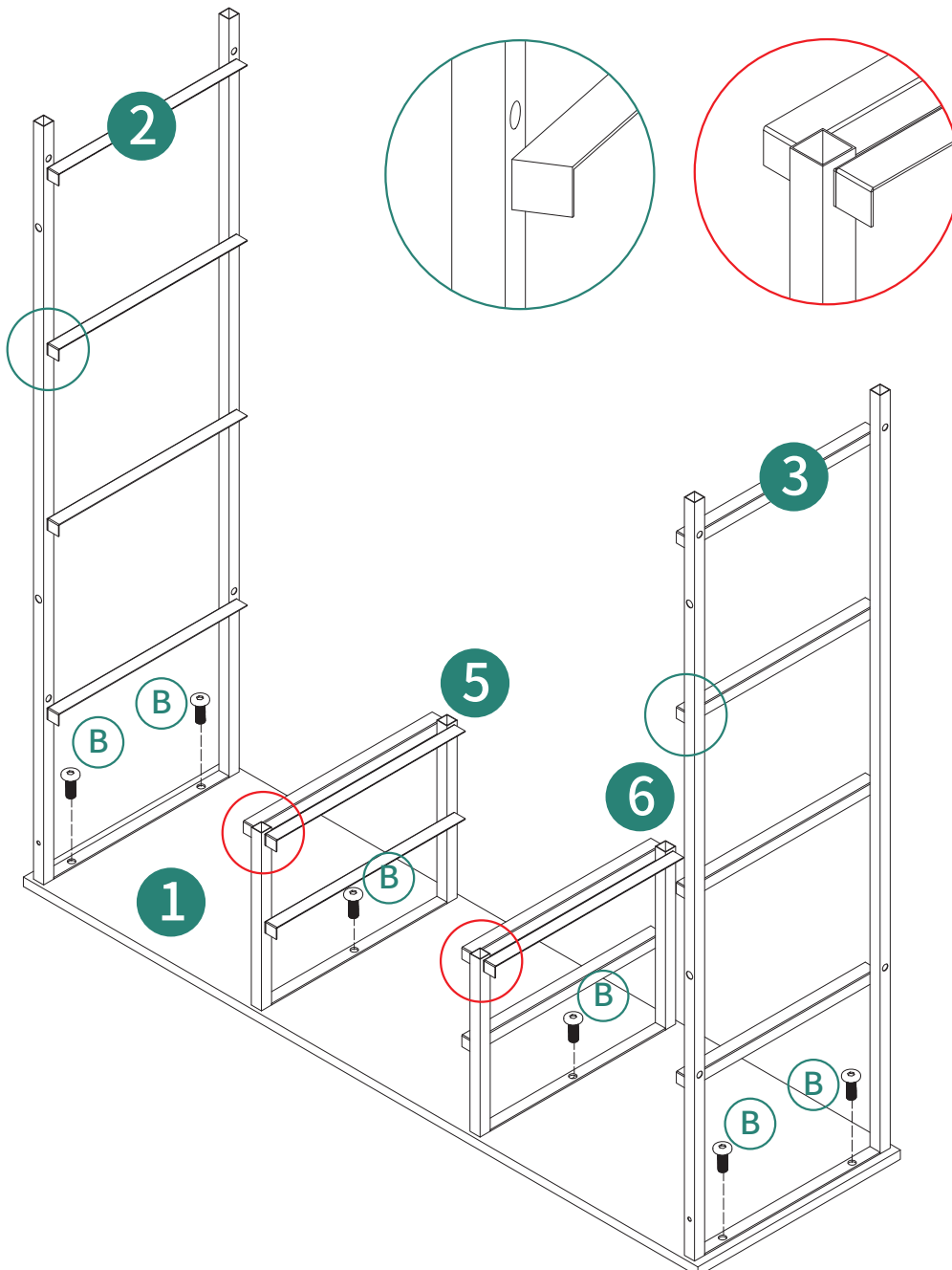

# 2

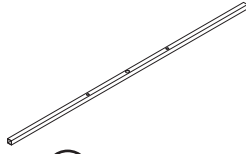

⑦ 2pcs

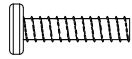

Ⓐ 8pcs

upward  
nach oben  
vers le haut  
Verso l'alto  
Hacia arriba

big hole	small hole	big hole	⑦
○	○	○	
großes Loch	kleines Loch	großes Loch	⑦
grand trou	petit trou	grand trou	
Foro grande	Foro piccolo	Foro grande	⑦
○	○	○	
Gran agujero	Pequeño agujero	Gran agujero	

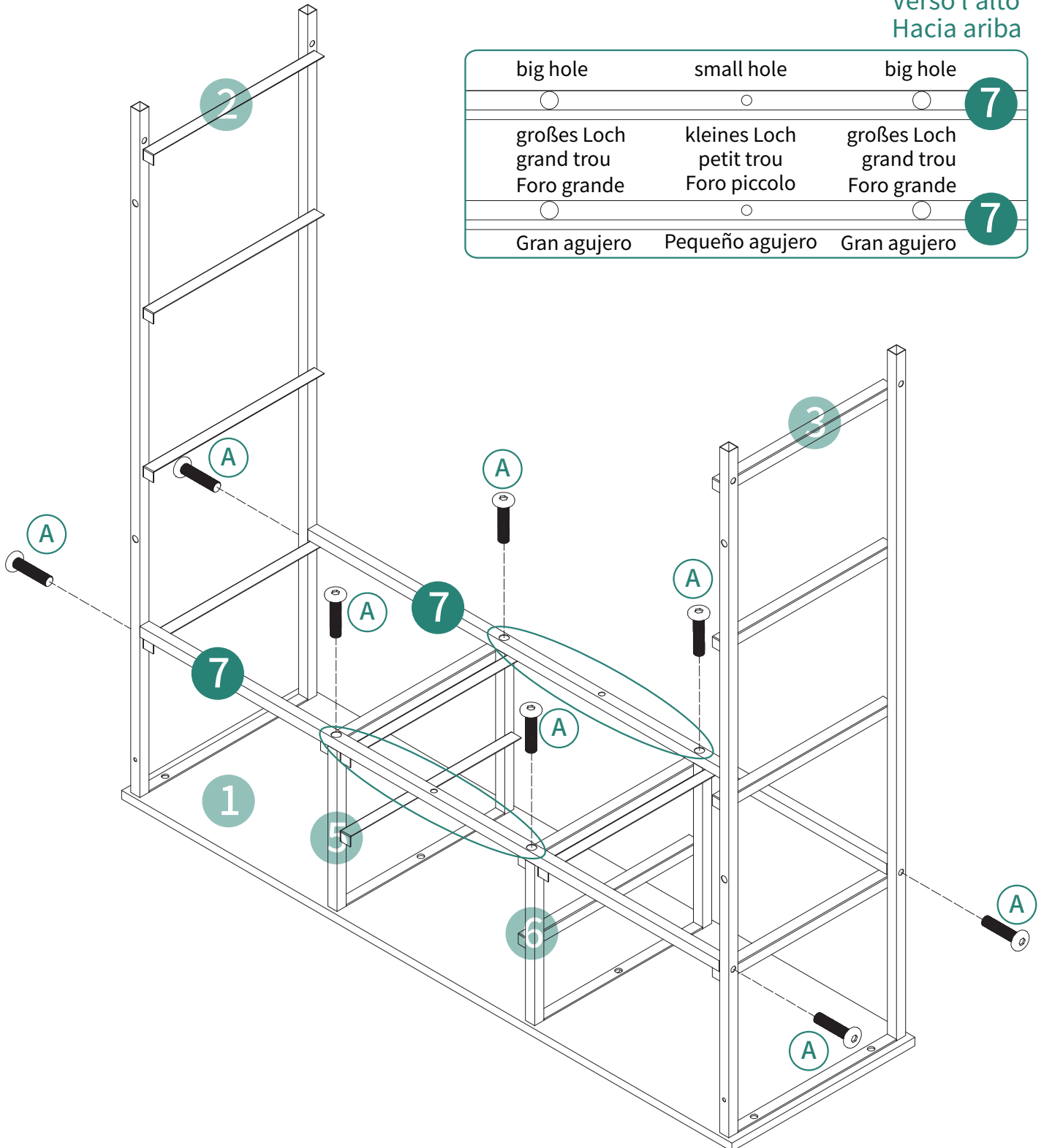

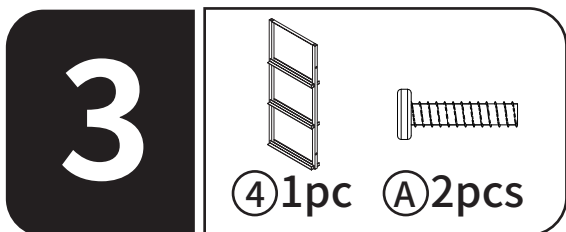

Please make sure that the iron frames are placed in the correct position and facing the correct direction.  
 Bitte vergewissern Sie sich, dass die Eisenrahmen gut aufgestellt sind und in die richtige Richtung zeigen.  
 Veuillez vous assurer que les cadres en fer sont placés dans la bonne position et dans la bonne direction.  
 Assicurarsi che i telai di ferro siano posizionati nella posizione corretta e rivolti nella direzione corretta.  
 Asegúrese de que los marcos de hierro están en la posición correcta y en la dirección correcta.

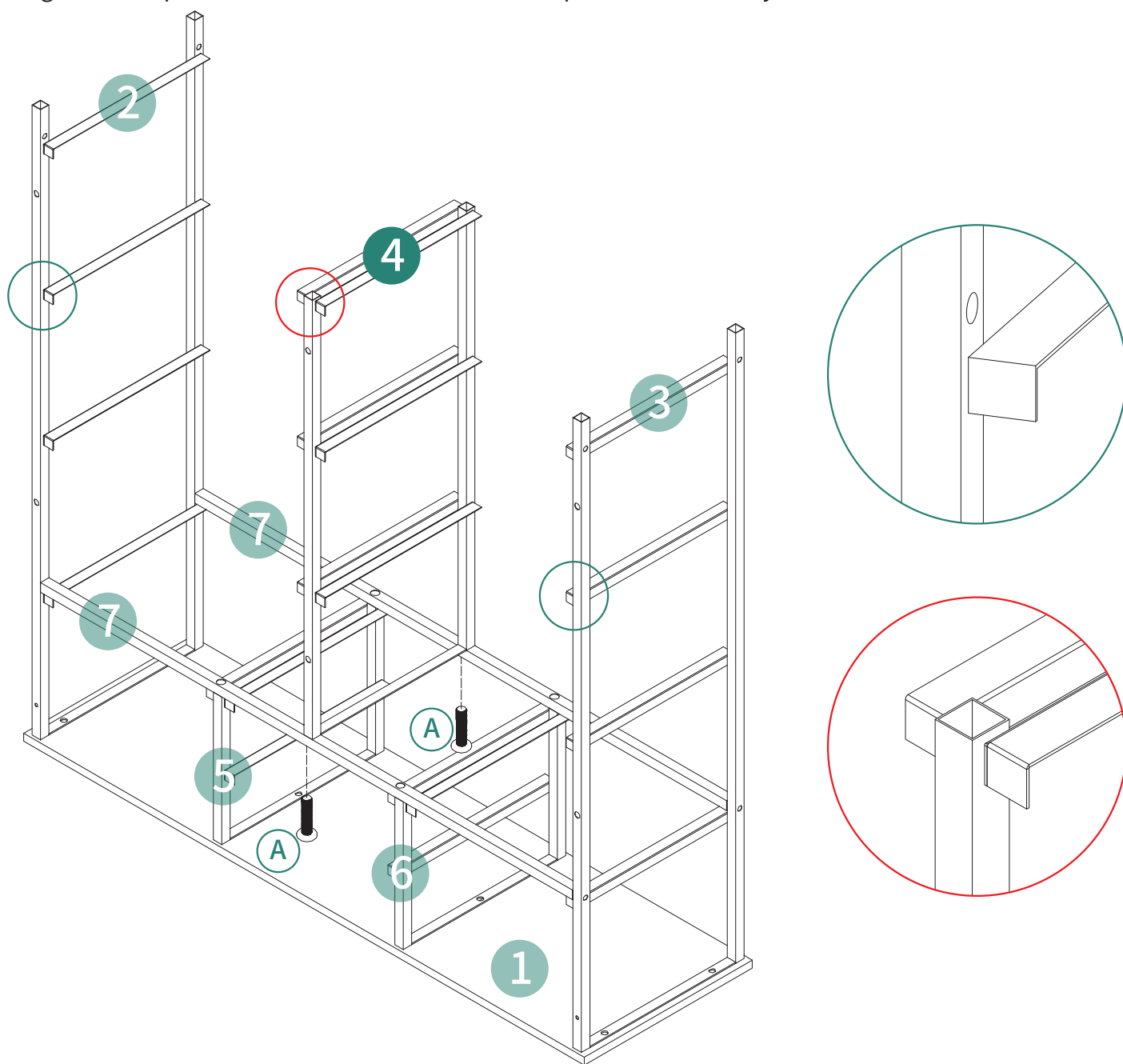

4

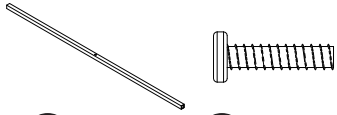

⑧ 2pcs    ①A 6pcs

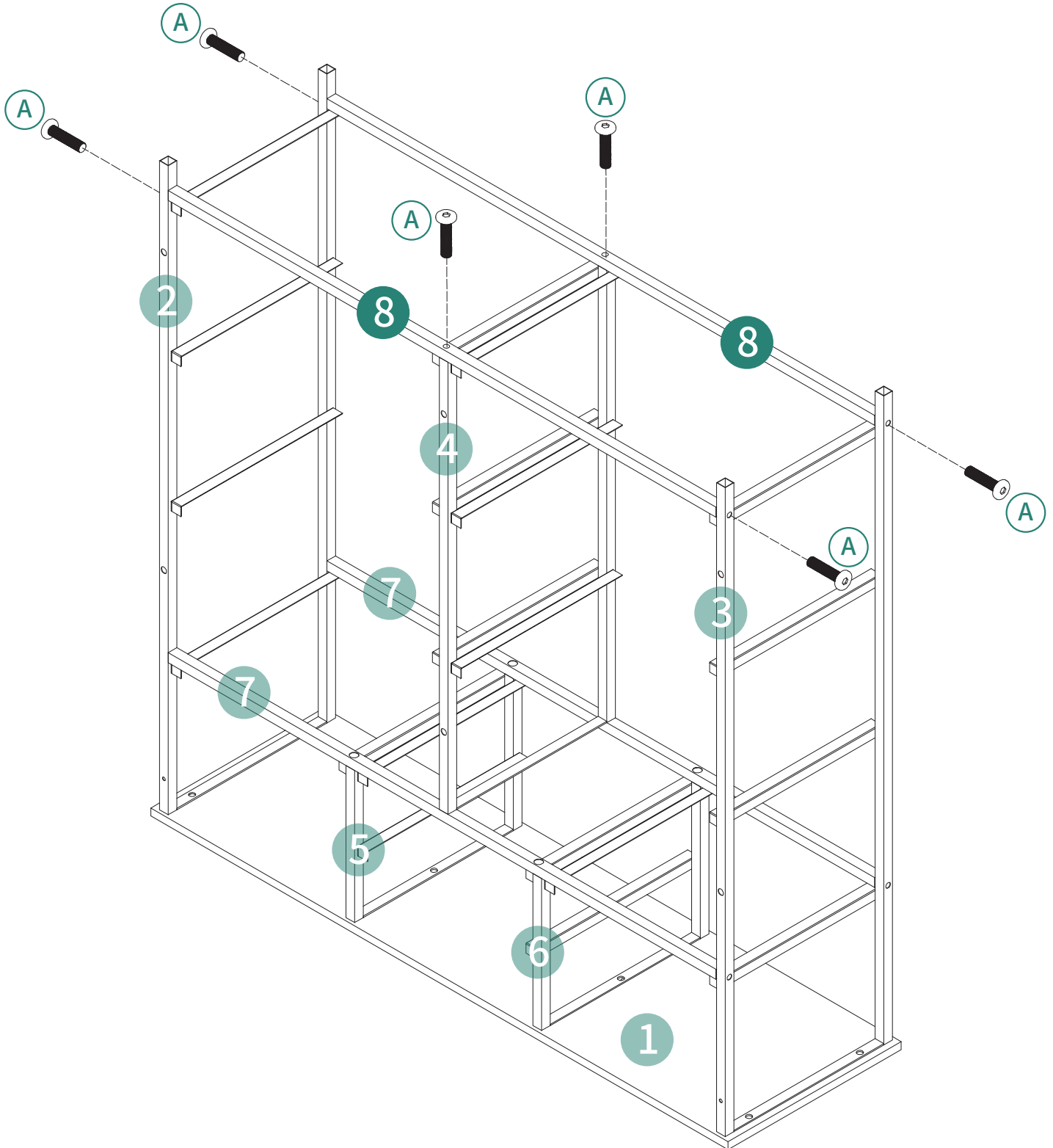

5

    
⑨ 2pcs    ⑧ 6pcs    ⑨ 4pcs

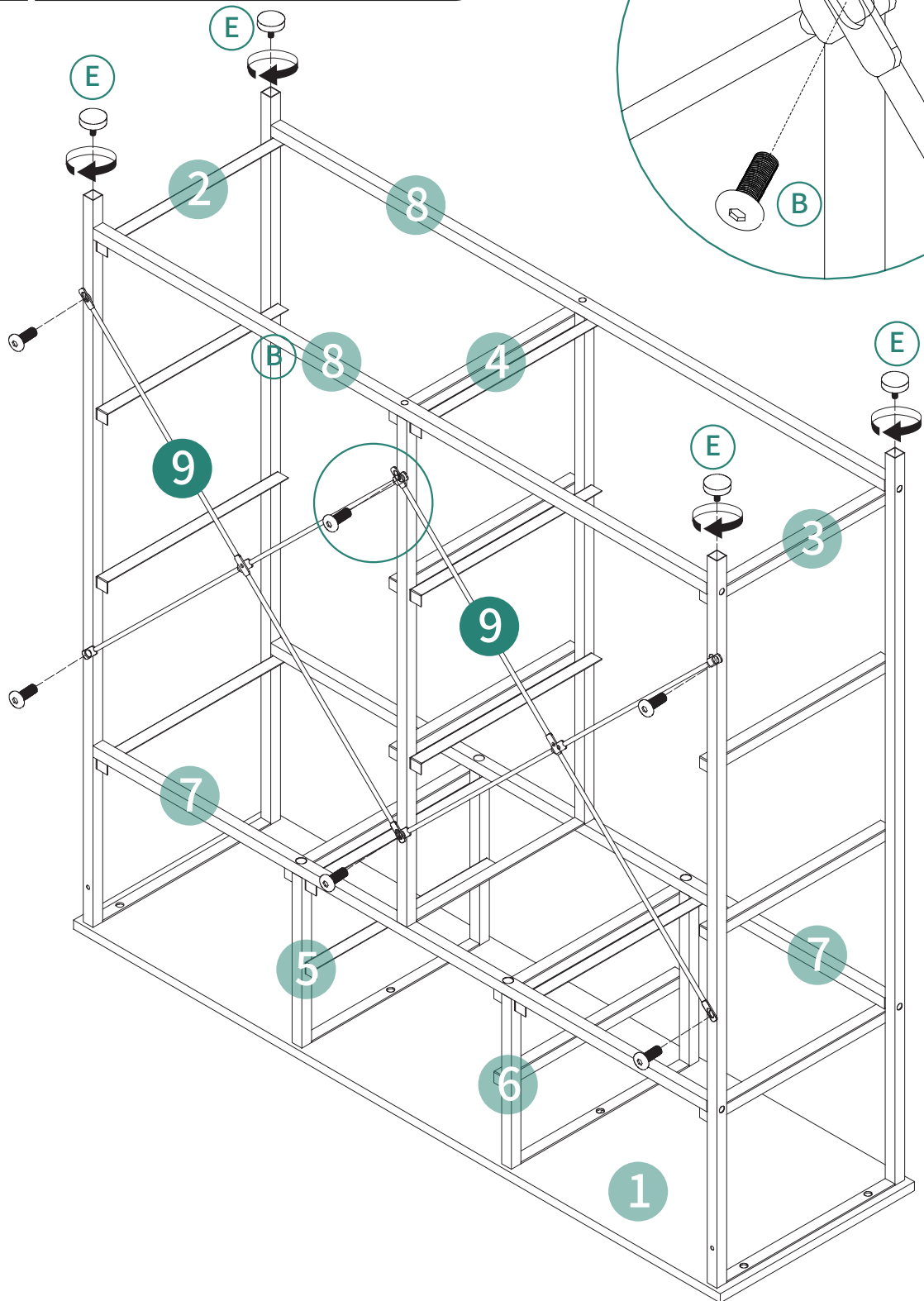
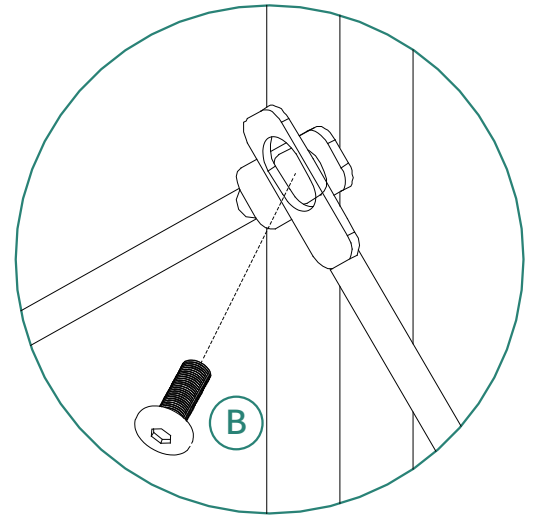

6

X2

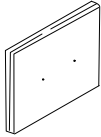

①1 2pcs

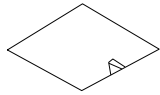

①4 2pcs



Ⓒ 4pcs



Ⓓ 2pcs

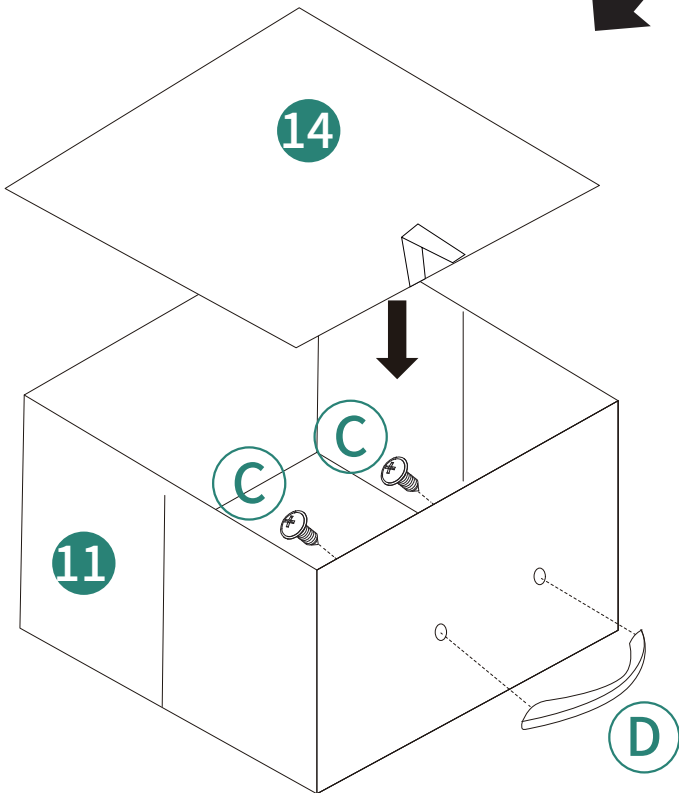
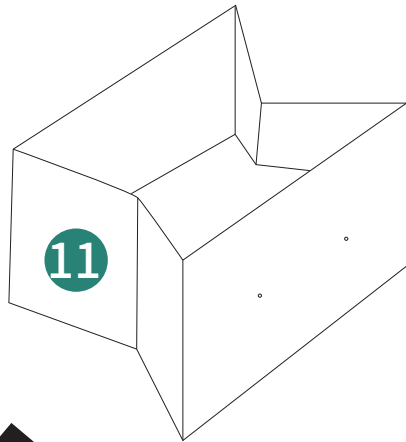
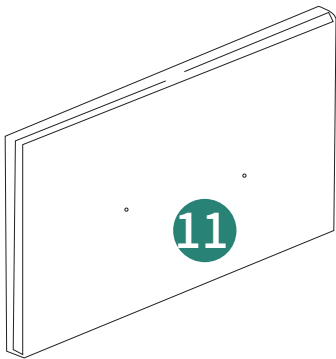

**7**  
**X2**

⑫2pcs ⑭2pcs ③4pcs ④2pcs

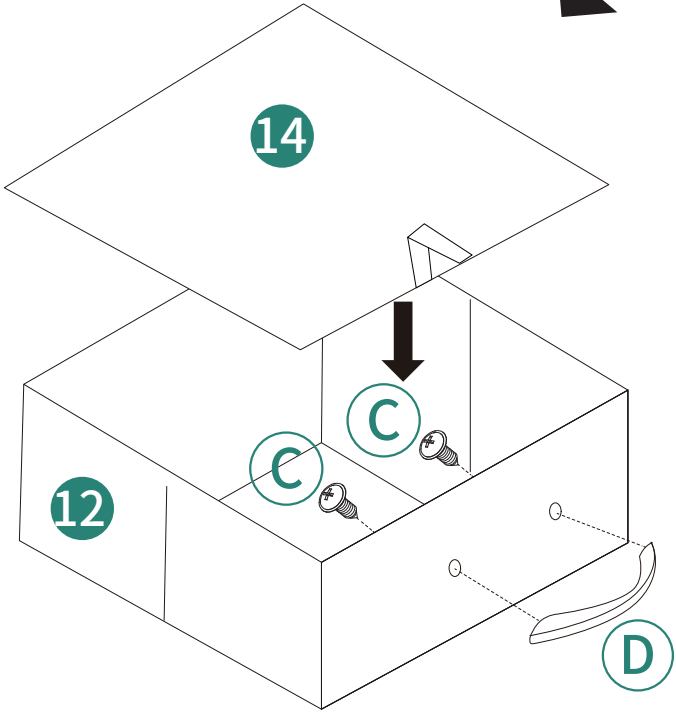
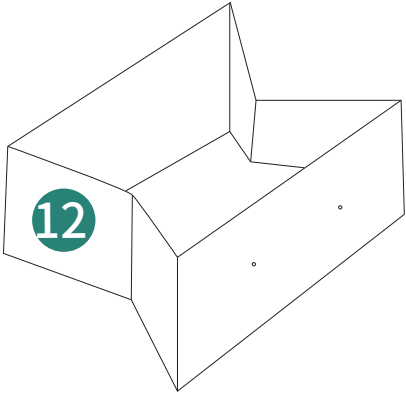
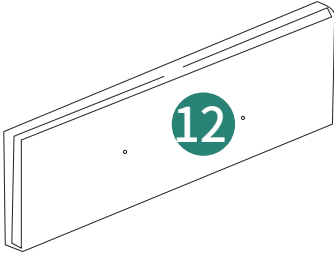

8

X6

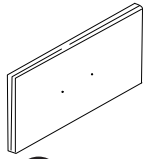

⑩6pcs

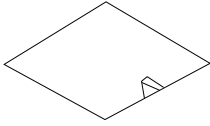

⑬6pcs



Ⓒ12pcs



Ⓓ6pcs

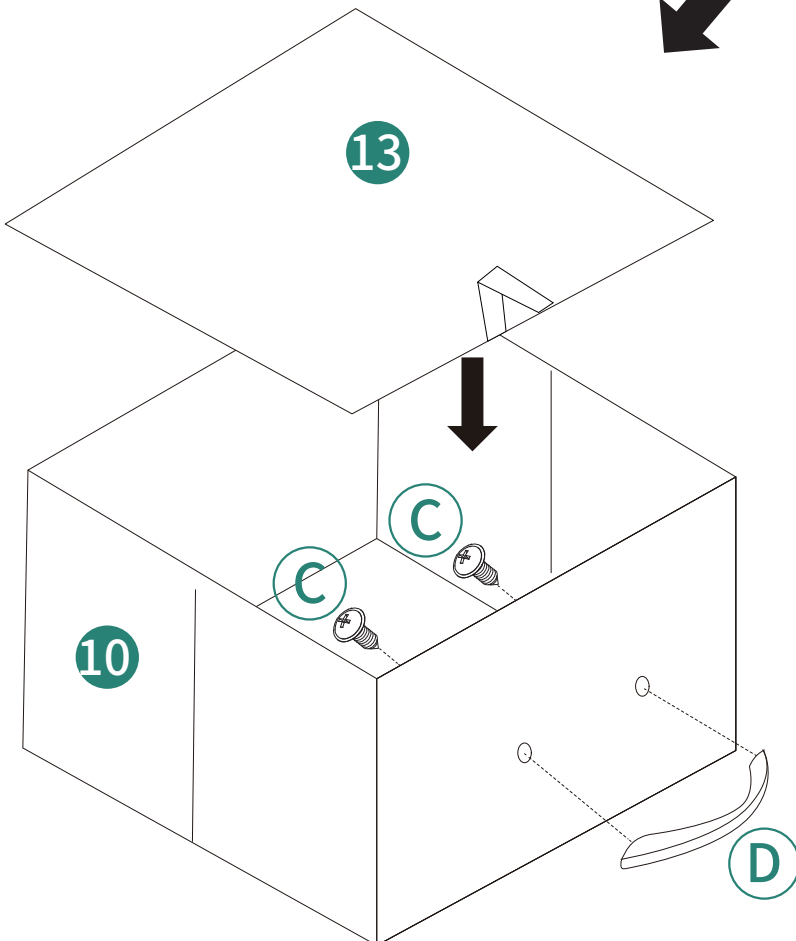
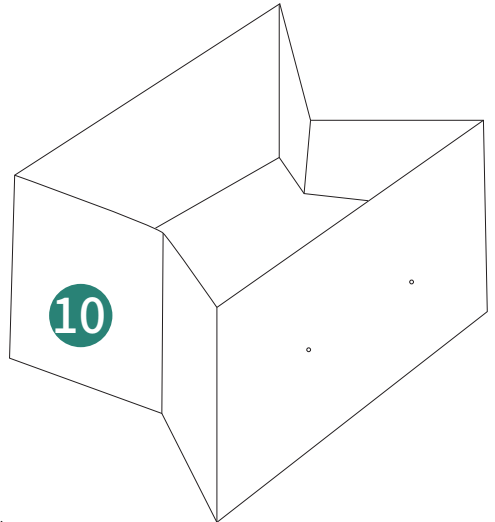
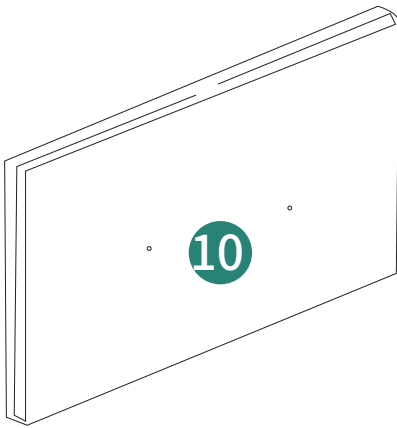

# 9

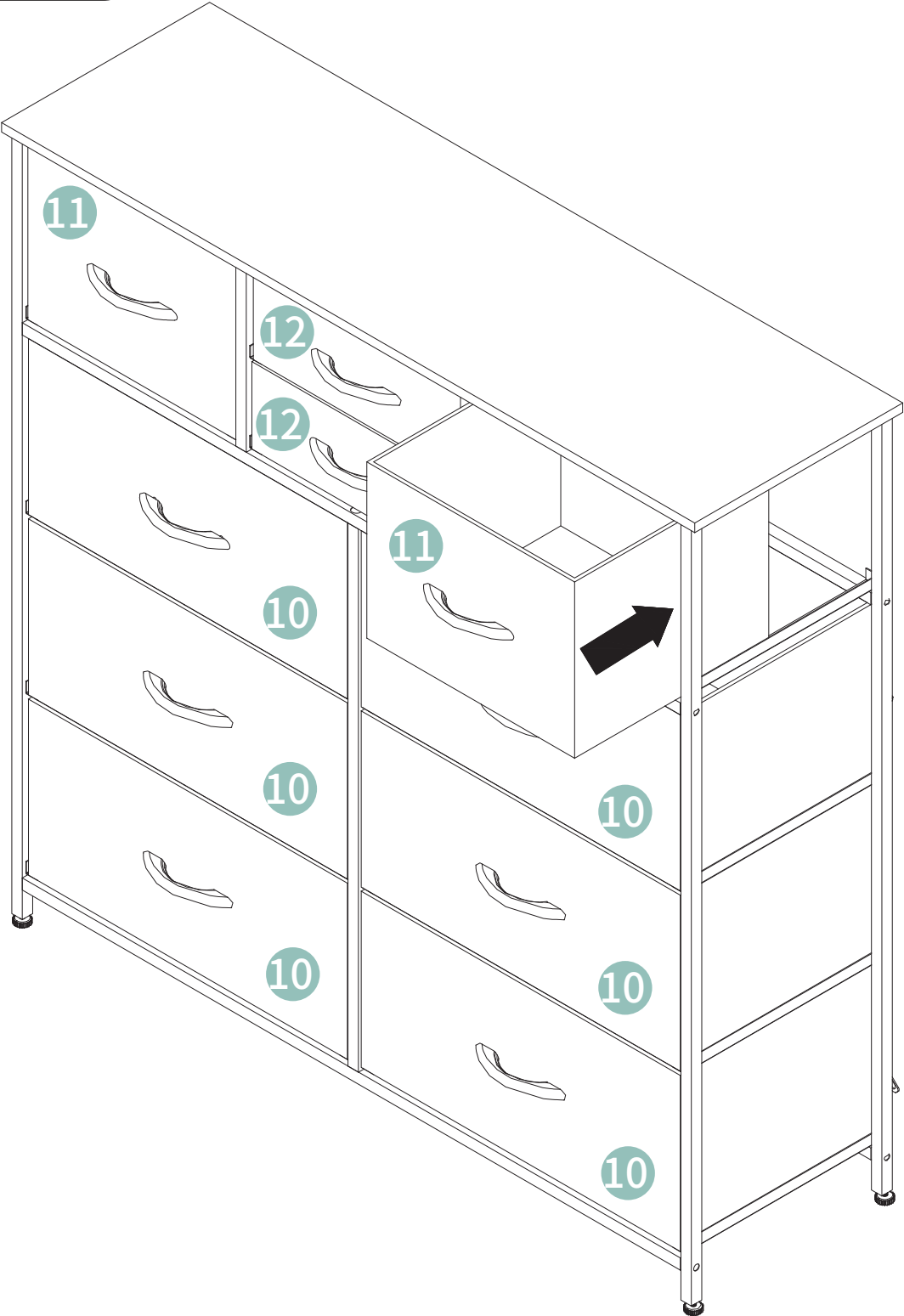

# 10



ⓕ2pcs

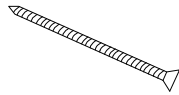

ⓖ2pcs

Fixing the fabric dresser to the wall is recommended. Please follow the instructions.

Es wird empfohlen, die Stoffkommode an der Wand zu befestigen.

Bitte befolgen Sie die Anweisungen.

Il est recommandé de fixer la commode en tissu au mur.

Veuillez suivre les instructions.

Si consiglia di fissare il comò in tessuto alla parete. Seguire le istruzioni.

Se recomienda fijar la cómoda de tela a la pared. Por favor, siga las instrucciones.

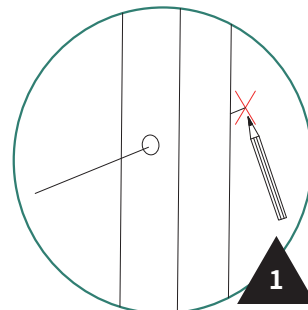
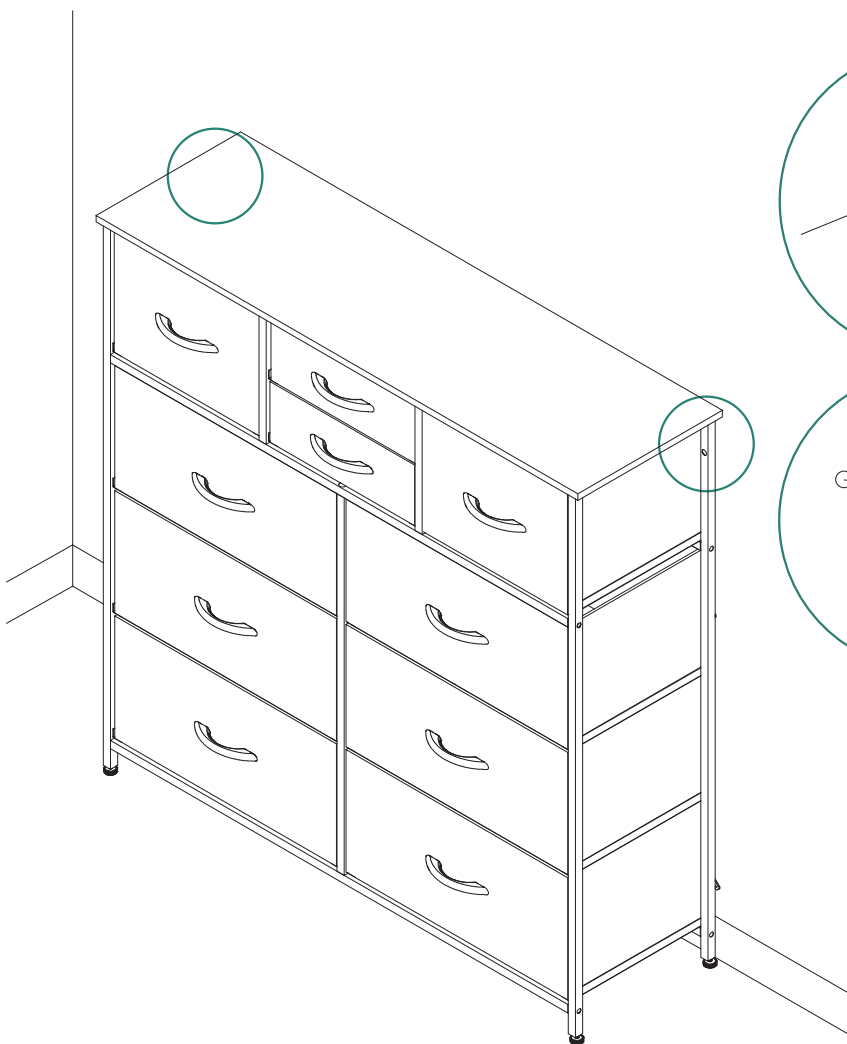

1

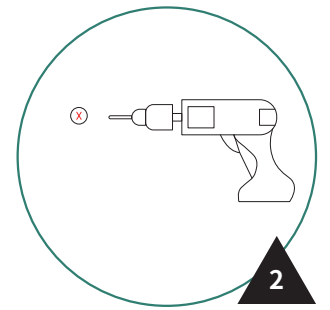

2

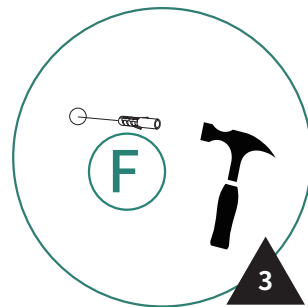

3

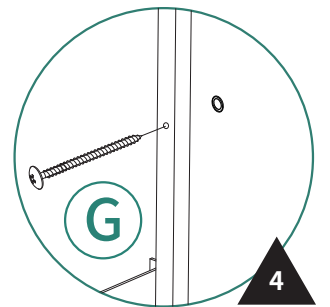

4

Installation Completed

Installation abgeschlossen

Installation complétée

Installazione completata

Instalación completada