

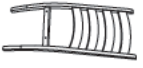













Assembly Instruction

LADDERBACK SIDE CHAIR

NO	Parts List		Q'TY
A		Chair Back	1
B		Box Seat	1
C		Hardseat	1
D		Left Front Leg	1
E		Right Front Leg	1
F		Left Side Stretcher	1
G		Righth Side Stretcher	1

NO	Hardware List		Q'TY
1		8 x 1" Wood Screw	6
2		8 x 1.1/4" Pan Head Screw	4
3		M6x 40mm JCBC Bolt	2
4		M6x70mm JCBC Bolt	6
5		M6x13mm Lock Washer	8
6		M6.5x16.5mm Flat Washer	8
7		M4 x 2.1/2" Allen Key	1
8		Assembly Glue	1

(STEP 1)

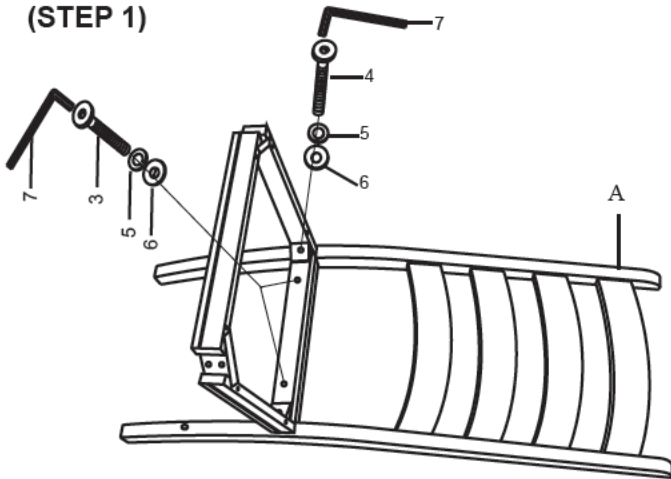

STEP 2

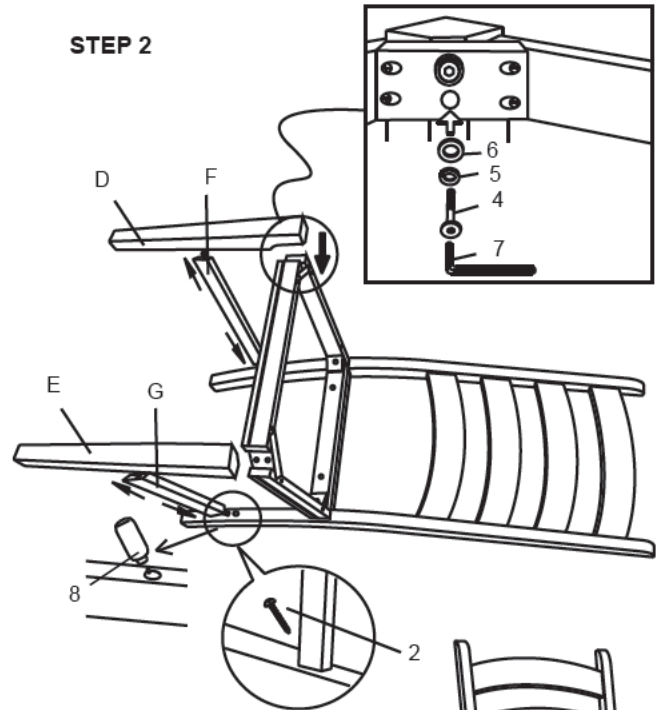

(STEP 3)

