



M  
MINKA  
AIRE

FUTURE

*INSTRUCTION MANUAL WARRANTY CERTIFICATE*

This product is protected by the United States Federal and/or State Law including Patents, Trademarks, and /or Copyright Laws.  
©2026 Minka Lighting, LLC. Manual design and elements of manual design are protected by United States Federal and/or State Law  
included Patents, Trademark, and / or Copyright Laws.



Minka-Aire® warranty is for one (1) year from the date of purchase from an authorized Minka-Aire® dealer. This warranty is only valid to the original purchaser or user against all defects in material and workmanship (light bulbs excluded) for one (1) full year. Additionally, Minka-Aire® warrants the motor only for the lifetime of the Minka Aire ceiling fan (excluding wall controls and electrical components), to the original purchaser or user.

- \* The warranty is voided with the use of any non- Minka-Aire® electrical devices, E.g., wall controls or electrical dimmer switches, etc...
- \* The warranty is void once the original purchaser or user ceases to own the fan or the fan is moved from its original point of installation.
- \* The warranty is void with the use of any hanger bracket (non-Minka Aire or non-fan specific) other than the hanger bracket supplied & installed with this specific fan.

## Warranty Service Information

To obtain warranty service during the warranty period, the purchaser should return the fan with the sales receipt to the original place of purchase. The authorized Minka-Aire® dealer, at its sole discretion, will either repair or replace the fan after verifying the legitimacy of the warranty claim. Replacement is subject to availability of the same model. If the model is unavailable it will be replaced by one of equal value. This is a limited warranty; The original purchaser or user is responsible for the cost of removal and reinstallation of repaired or replacement product.

To obtain the name of the Minka-Aire® authorized dealer nearest you call the Minka-Aire® customer care department at 1-800-307-3267, or contact Minka-Aire® through [www.minkagroup.net](http://www.minkagroup.net) and select FAQ to answer any questions, or, if you require additional assistance, submit the the question form found there.

Date Purchased \_\_\_\_\_

Store Purchased \_\_\_\_\_

Model Number \_\_\_\_\_ F756L

# ***CONTENTS***

SAFETY FIRST.....	1	INSTALLING THE LIGHT KIT/INSTALLING THE SHADE .....	8
PACKAGE CONTENTS.....	2	OPERATING THE REMOTE CONTROL/WALL CONTROL ...	9
BEGIN INSTALLATION.....	3	CARE OF YOUR FAN .....	10
HANGING THE FAN.....	4	TROUBLE SHOOTING.....	11
ELECTRICAL CONNECTIONS.....	5	SPECIFICATIONS .....	12
FINISHING THE INSTALLATION .....	6		
BLADE INSTALLANTION .....	7		



1860 Compton Ave, Corona CA 92881 • For Customer Assistance Call: 1-800-307-3267



# 1

## ***SAFETY FIRST***

1. Before you begin installing the fan, shut power off at the circuit breaker of the fuse box.
2. Be cautious! Read all instructions and safety information before installing your new fan. Review accompanying assembly diagrams.
3. Make sure that all electrical connections comply with local codes, ordinances, or National Electrical Codes. Hire a qualified electrician or consult a do-it-yourself wiring handbook if you are unfamiliar with installing electrical wiring.
4. Make sure the installation site you choose allows the fan blades to rotate without any obstructions. Allow a minimum clearance of 7 feet from the floor and 18 inches from the tip of the blades to the wall.
5. If you are mounting the fan to a ceiling fan outlet box, use a U.L. Listed metal octagonal outlet box marked Acceptable for Fan Support. Secure the box directly to the building structure. The outlet box and its support must be able to support the moving weight of the fan (at least 50 pounds) Do not use a plastic box.
6. Caution: To reduce the risk of injury use only the screws provided with the outlet box in conjunction with the lock washers provided with the fan.
7. If you are mounting the fan to a joist, make sure it is able to support the moving weight of the fan (at least 50 pounds).
8. After you install the fan, make sure that all mounting components are secured to prevent the fan from falling.
9. Do not insert anything into the fan blades while the fan is operating.
10. Turn the fan off and wait for the blades to stop completely before cleaning or performing any maintenance.

SUITABLE FOR USE IN  
WET LOCATIONS

**NOTE:**The important safeguards and instructions appearing in this manual are not meant to cover all possible conditions and situations that may occur. It must be understood that common sense, caution and care are factors which can not be built into this product. These factors must be supplied by the person (s) installing, caring for and operating the unit.

**NOTE: READ AND SAVE ALL INSTRUCTIONS!**

**WARNING**

**TO REDUCE THE RISK OF FIRE, ELECTRIC SHOCK OR OTHER PERSONAL INJURY. MOUNT FAN DIRECTLY TO THE BUILDING JOIST USING THE WOOD SCREWS AND WASHERS PROVIDED WITH THE FAN. THE WOOD SCREWS MUST GO THROUGH THE OUTLET BOX VIA THE KNOCK OUTS. CONSULT A QUALIFIED ELECTRICIAN IF IN DOUBT.**

**TO REDUCE THE RISK OF PERSONAL INJURY, DO NOT BEND THE BLADE HOLDERS WHILE INSTALLING, BALANCING THE BLADES, OR CLEANING THE FAN. DO NOT INSERT FOREIGN OBJECTS BETWEEN ROTATING FAN BLADES.**

**TO REDUCE THE RISK OF FIRE OR ELECTRONIC SHOCK, THIS FAN ONLY CAN USE KH968 RECEIVER AND RC1000 FAN REMOTE CONTROL ONLY.**

## 2

**PACKAGE CONTENTS**

- |   |                                    |
|---|------------------------------------|
| 1. Fan motor/housing assembly   | 13. Receiver(9 wire nuts included) |
| 2. 40W LED Light kit  | A. Mounting hardware:              |
| 3. Fan blades (8)   | #10x38mm Wood screws(2 pcs.)       |
| 4. Canopy   | #8-32x25mm Machine screws(2 pcs.)  |
| 5. Light kit plate  | Lock washers (2 pcs.)              |
| 6. PC shade   | 4mm Star washers (2 pcs.)          |
| 7. Water-proof grommet  | Washers (2 pcs.)                   |
| 8. Canopy cover   | B. Blade attachment hardware:      |
| 9. Hanger bracket   | 3/16*13mm screws(33 pcs)           |
| 10. Coupling cover  | $\Phi$ 5*14*1mm flat washer(33pcs) |
| 11. Downrod assembly  | C. Balance kit                     |
| 12. Remote control with holder<br>and 2 mounting screws<br>(1.5V*2AAA battery included) | D. Wire nut(3pcs)                  |

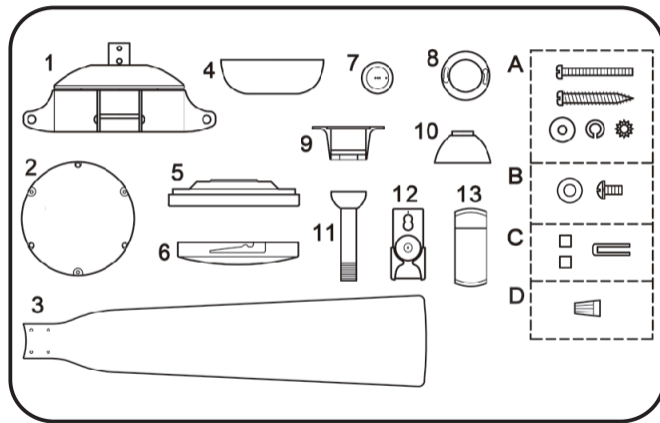

Tools Required: Phillips screw driver; slotted screw driver; pliers; wire cutters; electrical tape.

## BEGIN INSTALLATION

### MOUNTING OPTIONS

If there isn't an existing mounting box, then read the following instructions. Shut the power off at the circuit breaker or fuse box.

**NOTE: THIS CEILING FAN EXCEEDS THE MAXIMUM WEIGHT SPECIFIED BY UL FOR HANGING FROM A STANDARD OUTLET BOX. SPECIAL REINFORCEMENT OF THE CEILING IS REQUIRED FOR INSTALLATION.**

Secure the ceiling fan's hanging bracket directly from the building structure via the outlet box.

Figures 1, 2 and 3 are examples of different ways to mount the outlet box.

Note: You may need a longer downrod to maintain proper blade clearance when installing on a steep, sloped ceiling. Longer downrods are available from your Minka-Aire® dealer.

To hang your fan where there is an existing fixture but no ceiling joist, you may need to install a hanger bar as shown in Fig. 4 (available at your Minka-Aire® dealer).

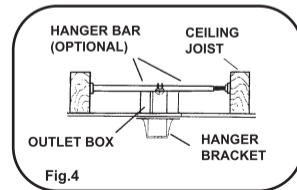
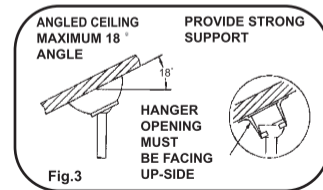
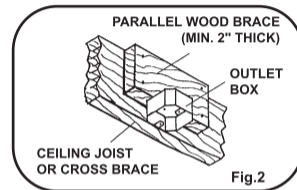
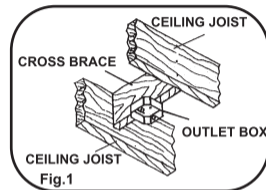

# 4

## ***HANGING THE FAN***

**WARNING:** All of the parts, hardware and components such as the hanger bracket and hanger ball have been provided for your safety and the proper installation of your new ceiling fan. The use of other parts, hardware or components not supplied by Minka Aire® with the fan will void the Minka Aire® Warranty.

**REMEMBER** to turn off the power. Follow the steps below to hang your fan properly;

Step 1: Remove the clevis pin and B clip from downrod assembly.(Fig. 5)

Step 2: Remove the cross pin and set screw from downrod assembly.(Fig. 6)

Step 3: Route wires through coupling cover, canopy cover, canopy and hanger ball and downrod.(Fig. 7)

Step 4: Thread the downrod into the coupler, reinstall the clevis pin and B clip, tighten the set screws, and slip the coupling cover onto the fan body.(Fig.8 & Fig.9)

Step 5: Reinstall the hanger ball onto rod being sure that cross pin is in the correct position, set screw is tighten and wires are not twisted.

(Fig.10) Note: Two positions for the clevis pin, but do not change the set screws position.

Step 6: Assemble the water proof grommet for hanger ball. Carefull have wires go through the grommet.(Fig.11)

Step 7: Secure the hanger bracket to the ceiling outlet box using screws included with your outlet box and washers included with the fan.(Fig.12)

Step 8: Now lift motor assembly into position and place hanger ball into hanger bracket. Rotate until the check groove has dropped into the registration slot and seats firmly. Rod should not rotate if this is done correctly(Fig.13)

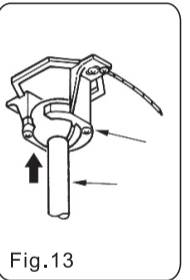
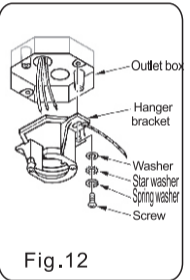
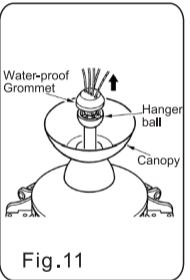
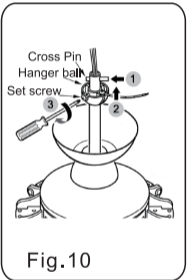
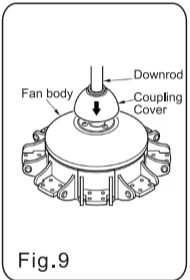
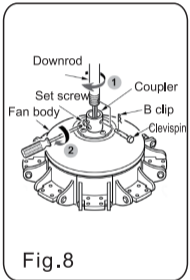
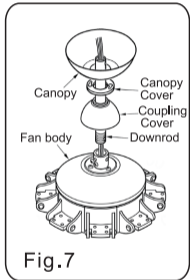
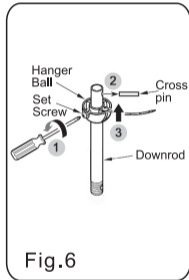
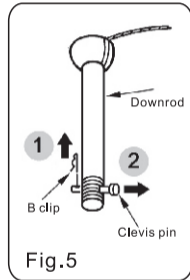

## 5

## ELECTRICAL CONNECTIONS

**WARNING:** The use of Dimming devices not compatible with ceiling fans will cause unwanted behavior including loud humming and will cause permanent damage to you fans electrical component.

**WARNING:** To avoid possible electrical shock be sure electricity is turned off at the main fuse or breaker box before wiring.

**Note:** The universal hand held remote control System is equipped with learning frequency function which has 1024 code combinations to prevent potential interference from other remote units. The frequency on your Receiver and Transmitter units have been preset at the factory. (Fig.14). No frequency change is necessary, should you desire to install another fan within the same home or area with a separate frequency code please see the "frequency interference" troubleshooting section of this instruction manual to learn how to change the frequency.

**Note:** Fan must be installed from a maximum distance of 40 feet from the transmitting unit for proper signal transmission between the transmitting unit and the fan's receiving unit.

**Step 1:** Insert the receiver unit into the hanger bracket with the flat side of the receiver facing the ceiling.(Fig.15)

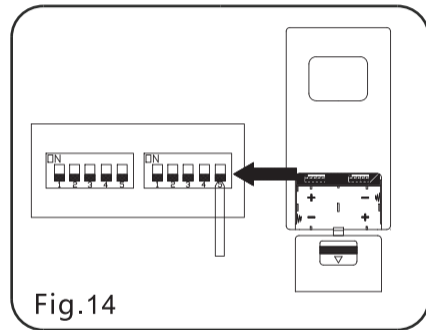

Fig.14

Step 2: Motor to Receiver electrical connections: connect the WHITE WIRE from the fan to the WHITE wire from receiver. Connect the RED wire from the fan to the RED wire from the Receiver. Connector the BLUE wire from the fan to the BLUE wire from the receiver. connect the PURPLE wire from the fan to the PURPLE wire from the receiver. Connect the GREY wire from the fan to the GREY wire from the receiver.(Fig.16)

Step 3: If your outlet box has a GROUND wire (Green or Bare Copper) connect this wire to the Hanger Ball and Hanger Bracket and receiver Ground wires. If your outlet box does not have a Ground Wire ,then connect the Hanger Ball and Hanger Bracket and receiver Ground Wires together.Secure wire connection with the plastic wire nut provided. (Fig.16)

Step 4: Receiver to House Supply Wires Electrical connections: Connect the WHITE wire from the outlet box to the WHITE wire from the receiver. Connect the GREEN wire from outlet box to the GREEN wire from the receiver and fan. Secure all wire connections with the plastic wire nuts provided. After all splices are made, check to make sure there are no loose strands. As an additional precaution we suggest to secure the plastic wire connectors to the wires with electrical tape.(Fig.16)

**WARNING:** Changes or modifications not expressly approved by the party responsible for compliance could void the user's authority to operate the equipment.

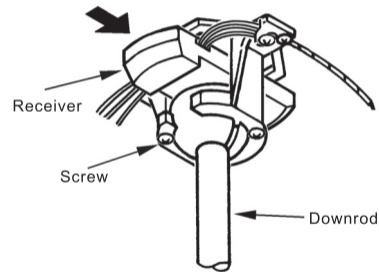

Fig.15

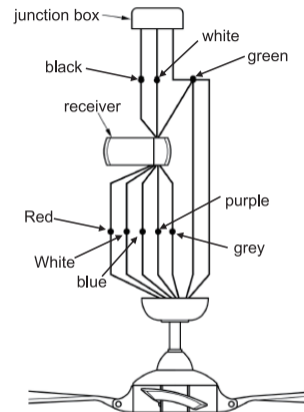

Fig.16

## 6

**FINISHING THE INSTALLATION**

Step 1. Remove 1 of the 2 screws from the bottom of the hanger bracket and loosen the other one half a turn from the screw head. (Fig. 17)

Step 2. Slide the canopy up towards the hanger bracket and place the key hole on the canopy over the screw on the hanger bracket, turn canopy until it locks in place at the narrow section of the key holes. (Fig. 18)

Step 3. Align the circular hole on canopy with the remaining hole on the hanger bracket, secure by tightening the two set screws. (Fig. 18)

Step 4. Twist the canopy cover to fit it on canopy. (Fig.19)

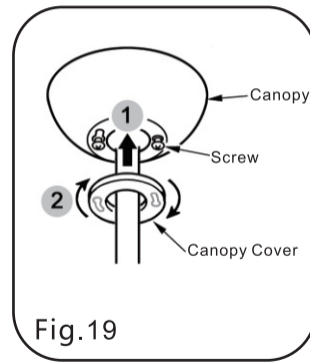
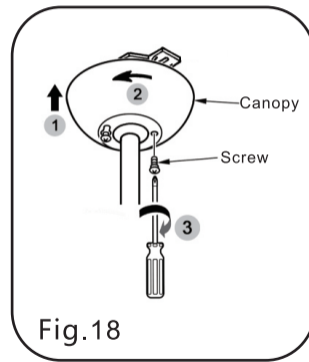
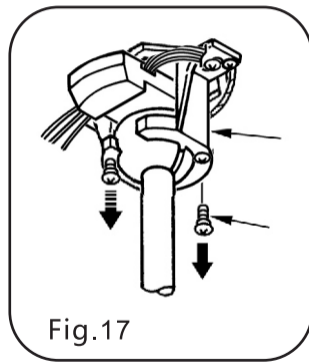

## ***BLADE INSTALLATION***

Assemble the blade onto the motor. Align the four holes of the blades with the motor and tighten them with the screw and washer pack B .Repeat the process for remained blades.(Fig. 20)

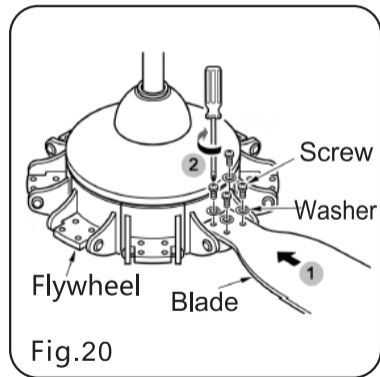

# 8

## ***INSTALLING THE LIGHT KIT / INSTALLING THE SHADE***

**NOTE:** Before starting installation, make sure power is turned off at the circuit breaker.

Step 1: Remove 1 of 3 screws on light kit adapter and loosen the other 2 screws.  
(Fig. 21)

Step 2: Slide the light kit plate up towards the light kit adapter and place the key holes over the screws on the light kit adapter. Turn light kit plate until it locks in place at the narrow section of key holes.(Fig. 22)

Step 3: Align the round hole of the light kit plate with light kit adapter, tighten all 3 screws.(Fig. 23)

Step 4: Remove the 3 screws from light kit plate And connect the wires between the fan and LED assembly with the connectors.(Fig. 24&25)

Step 5: Tighten the LED assembly to light kit plate with 3 screws.(Fig. 26)

Step 6: Align the slot of the light PC shade with the aised dimple on the light kit plate and turn it clockwise until it stops.(Fig. 27)

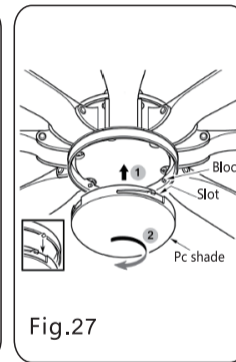
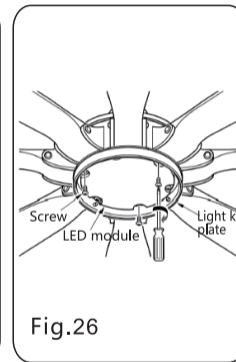
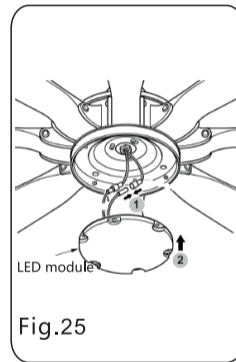
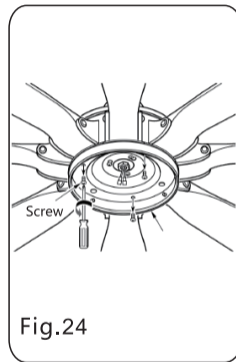
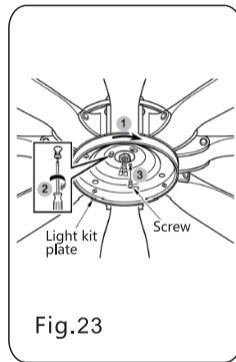
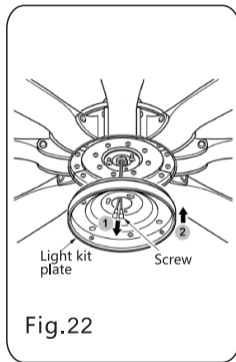
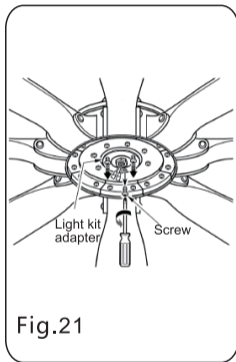

## OPERATING THE REMOTE CONTROL/WALL CONTROL

Remote Control only: Install 2pcs AAA battery (included). To prevent damage to transmitter remove the battery if not used for long periods of time.

Your DC brushless motor is equipped with a self learning frequency function remote control. Restore power to ceiling fan and test the transmitter as below for proper operation:

A. 1, 2, 3, 4, 5 and 6 button:

These six buttons are used to set the fan speed as follows:

1 = minimum speed

2 = low speed

3 = medium low speed

4 = medium speed

5 = medium high speed

6 = high speed

B.  Reverse button:

This button is used to change the direction of the rotation of the blades; forward for warm weather or reverse for cold weather.

C.  button:

This button turns the power Off to the Fan.

D.  Button:

These buttons turn the light ON or OFF and also control the brightness settings of the light. The following instructions apply to ceiling fans that feature a DOWN light

( button) only or ceiling fans that feature an UP light ( button) and a DOWN light ( button) that are controlled independent of each other;

Press and release the button for the desired light to turn the light ON or OFF. Press and hold the button to set the desired light brightness. The light will cycle between bright and dim settings as long as the button is pressed. The light key has an automatic auto-resume feature that allows the light to remain at the same brightness as the last time it was turned off.

Speed settings for warm or cold weather depend on factors such as room size, ceiling height and number of fans.

**NOTE:** To change the direction of the rotation of the blades the fan must be in operation mode.

**Warm Weather (forward)**

A **DOWNWARD** airflow creates a cooling effect as shown in Figure 28. This allows you to set your air conditioner on a warmer setting without affecting your comfort.

**Cool Weather (Reverse)**

An **UPWARD** airflow moves warmer air off the ceiling area as shown in Figure 29. This allows you to set your heating unit on a cooler setting without affecting your comfort.

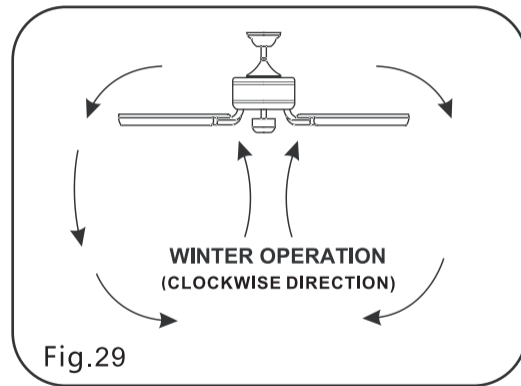
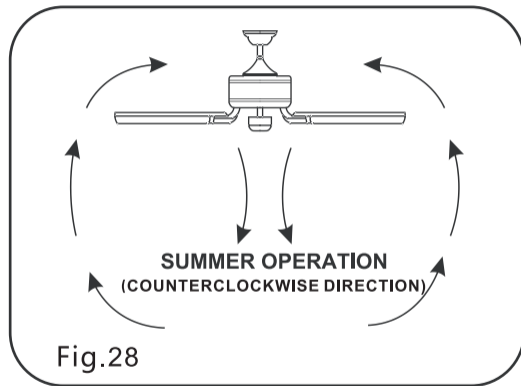

Here are some suggestions to help you maintain your fan.

1. Because of the fan's natural movement, some connections may become loose. Check the support connections, brackets, and blade attachments twice a year. Make sure they are secure (It is not necessary to remove fan from ceiling.)
2. Clean your fan periodically to help maintain its new appearance over the years. Do not use water when cleaning. This could damage the motor, or the wood, or possibly cause an electrical shock.
3. Use only a soft brush or lint-free cloth to avoid scratching the finish. The plating is sealed with a lacquer to minimize discoloration or tarnishing.
4. You can apply a light coat of furniture polish to the wood for

## *CARE OF YOUR FAN*

additional protection and enhanced beauty. Cover small scratches with a light application of shoe polish.

5. There is no need to oil your fan. The motor has permanently lubricated bearings.

### **WARNING**

**MAKE SURE THE POWER IS OFF AT THE ELECTRICAL PANEL BOX BEFORE YOU ATTEMPT ANY REPAIRS. REFER TO THE SECTION, 'MAKING ELECTRICAL CONNECTIONS'.**

## TROUBLESHOOTING

### SYMPTOM

Fan will not start

### SOLUTION

1. Check to make sure the wall switch is turned on.
2. Check circuit fuses or breakers.
3. Caution! Make sure the power is turned off before performing the following steps.
4. Remove canopy and check wire connections.
5. Check wall control transmitter connections (if applicable).
6. Note: Fan must be installed from a maximum distance of 40 feet from the transmitting unit for proper signal transmission between the transmitting unit and the fan's receiving unit.

### SYMPTOM

Fan sound noisy

### SOLUTION

1. Allow a 24-hour 'break in' period. Most noises associated with a new fan will go away during this time.
2. Make sure all blade attachment screws are tight.
3. Make sure outlet box is secured to building structure, if necessary use the wood screws provided to further secure outlet box to joist.
4. Make sure hanger bracket is secure to the outlet box, screws are tight.

### SYMPTOM

Fan Wobble

### SOLUTION

1. NOTE: All blade sets are grouped by weight. Because wood and plastic blades vary in density, the fan may wobble even though blades are matched.
2. Make sure outlet box is secured to building structure, if necessary use the wood screws provided to further secure outlet box to joist.
3. Make sure hanger bracket is secure to the outlet box, screws are tight.
4. Use the balancing kit provided if the wobble is excessive (follow instructions included with balance kit)

## SYMPTOM

Frequency interference

## SOLUTION

1. Turn the power off to your ceiling fan.
2. Please use a small size tool to change the frequency setting on the control system.
3. Return power to the unit Note: After the AC power is on, do not press any other button on the transmitter before pressing the "Stop" button, doing so will cause the procedure to fail.
4. Within 60 seconds of turning the Fan's AC power ON. Press the transmitter's "Stop" button for 5 seconds.
5. **Once the receiver has detected the frequency, the down light will blink twice and the fan will begin to rotate for a short period and then shut off.**
6. The receiver has now learned the frequency which has been selected on the transmitter. After completing the steps above, you should be able to operate the ceiling fan and light. If the fan is not responding to the transmitter, please turn the power off to the receiver, and repeat the process.

# SPECIFICATIONS

These are typical readings. Your actual fan may vary. They do not include amps and wattage used by the light (s).

For any additional information about your Minka Aire® Ceiling fan, please write to:

Fan Size	Speed	Volts	Amps	Watts	RPM	N.W.	G.W.	C.F.
65 "	Low	120	0.13	6.03	54	11.1 kgs	13.0 kgs	3.91'
	High	120	0.57	36.87	100			



1860 Compton Ave, Corona CA 92881 • For Customer Assistance Call: 1-800-307-3267

# ENERGYGUIDE

Estimated  
Yearly Energy Cost

**\$ 7**

\$3 | | | \$34

Cost Range of Similar Models (19"—84")

- Based on 12 cents per kWh and 6.4 hours use per day
- Your cost depends on rates and use
- Energy Use: 25Watts

All estimates based on typical use, excluding lights

Airflow

**6,072**

Cubic Feet Per Minute

- The higher the airflow, the more air the fan will move
- Airflow Efficiency: 246 Cubic Feet Per Minute Per Watt

[ftc.gov/energy](http://ftc.gov/energy)

FAN SPEED	AIRFLOW (CFM)*	POWER USE (watts)	AIRFLOW EFFICIENCY (CFM/watt)
Low	3977	6.03	660
High	7921	36.87	215

**Ceiling fan airflow is measured in cubic feet per minute (CFM). Power use is measured in watts. To maximize energy savings:**

- Choose a fan with high airflow efficiency (CFM/watt).
- Use ENERGY STAR<sup>®</sup>-labeled lighting in your fan.
- Remember to switch off your fan when you leave the room.

\* Measured according to the DOE approved Solid State test method

*For any additional information about your Minka Aire<sup>®</sup> Ceiling fan, please write to:*

**M**  
**MINKA**  
AIRE

1860 Compton Ave, Corona CA 92881 • For Customer Assistance Call: 1-800-307-3267

MKA26040906

← English Verison