

EN_IMPORTANT, RETAIN FOR FUTURE REFERENCE: READ CAREFULLY.

FR_IMPORTANT: A LIRE ATTENTIVEMENT ET À CONSERVER POUR CONSULTATION ULTÉRIEURE.

ES_IMPORTANTE, LEA Y GUARDE PARA FUTURAS REFERENCIAS.

PT_IMPORTANTE, RETER PARA REFERÊNCIA FUTURA: LEIA ATENTAMENTE.

DE_WICHTIG! SORGFÄLTIG LESEN UND FÜR SPÄTER NACHSCHLAGEN AUFBEWAHREN.

IT_IMPORTANTE! CONSERVARE IL PRESENTE MANUALE PER FUTURO RIFERIMENTO E LEGGERLO ATTENTAMENTE.

BOX
1-2

2 x 1

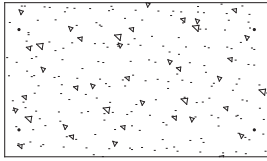

BOX
2-2

1 x 1

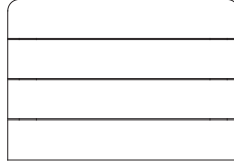

11 x 1

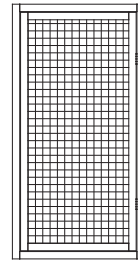

3 x 2

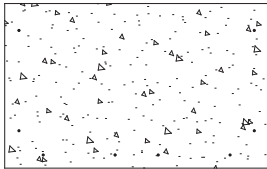

4 x 2

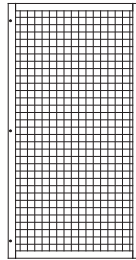

12 x 1

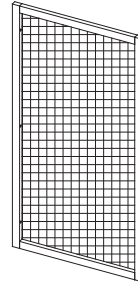

6 x 4

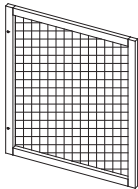

5 x 2

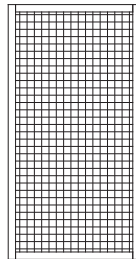

13 x 2

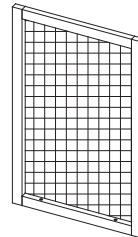

7 x 2

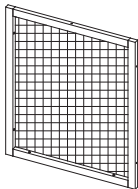

8 x 2

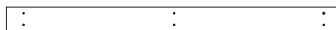

14 x 2

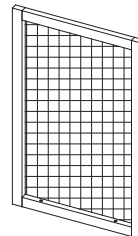

9 x 2

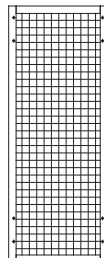

15 x 12

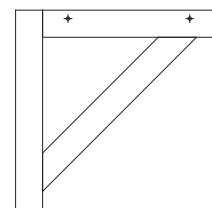

10 x 2

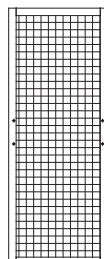

Hardware Kit

1 x 6

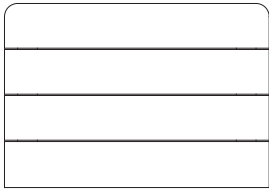

2 x 1

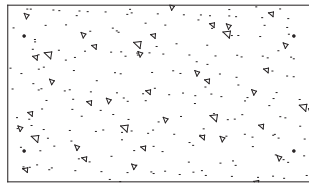

3 x 2

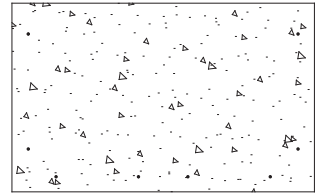

4 x 2

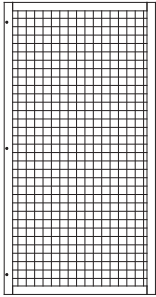

5 x 2

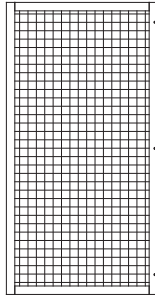

6 x 4

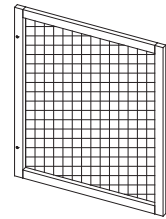

7 x 2

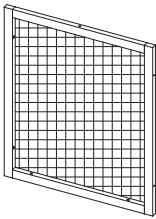

8 x 2

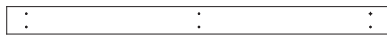

9 x 2

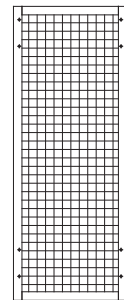

10 x 2

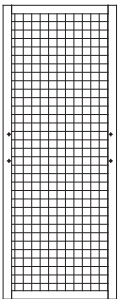

11 x 1

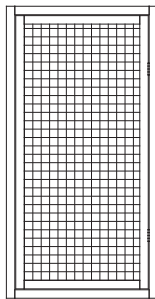

12 x 1

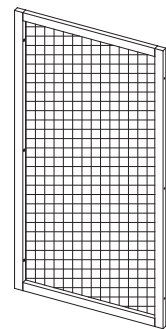

13 x 2

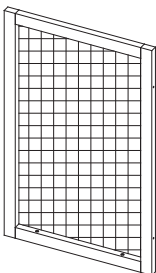

14 x 2

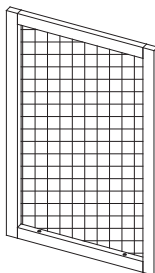

15 x 12

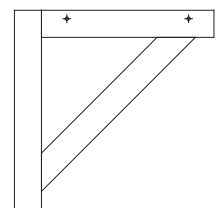

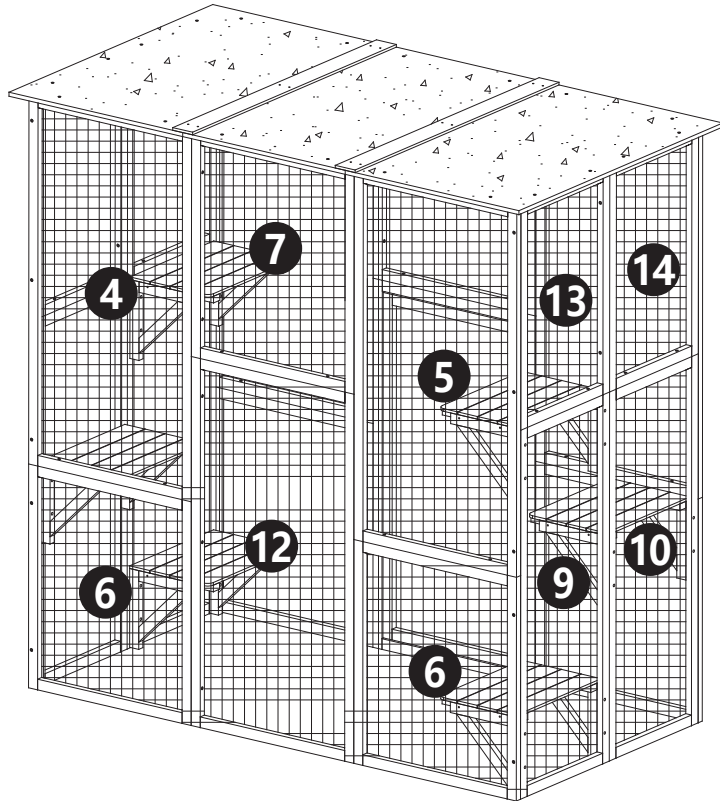
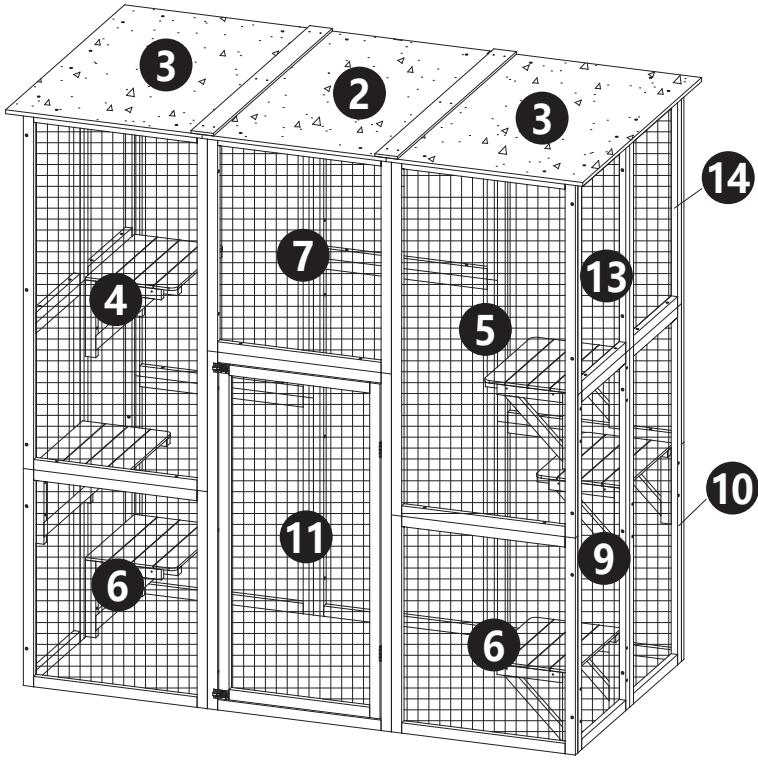

A x20
M3.5x30
+2(spare)



B x44
M3.5x40
+2(spare)



C x50
M3.5x55
+2(spare)



D x12
M3.0x20
+1(spare)



E x12
M3.0x16
+1(spare)



F x24
M6.0x60
+2(spare)



G x 2

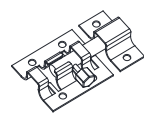

H x 2
Φ6 x 20



EN Do not confuse similar screws. Do not tighten bolts fully until all parts are connected!
FR Ne pas confondre des vis similaires. Ne serrez pas les boulons à fond tant que toutes les pièces ne sont pas connectées!
ES No confunda tornillos similares. No apriete los tornillos completamente hasta que todas las partes están conectadas!
PT Não confundir parafusos semelhantes. Não apertar completamente os parafusos até que todas as peças estejam encaixadas!
DE Verwechseln Sie ähnliche Schrauben nicht. Ziehen Sie die Schrauben erst fest an, wenn alle Teile verbunden sind!
IT Non confondere le viti simili. non serrare completamente i bulloni fino a tutte le parti non sono ancora collegate!

NOTE

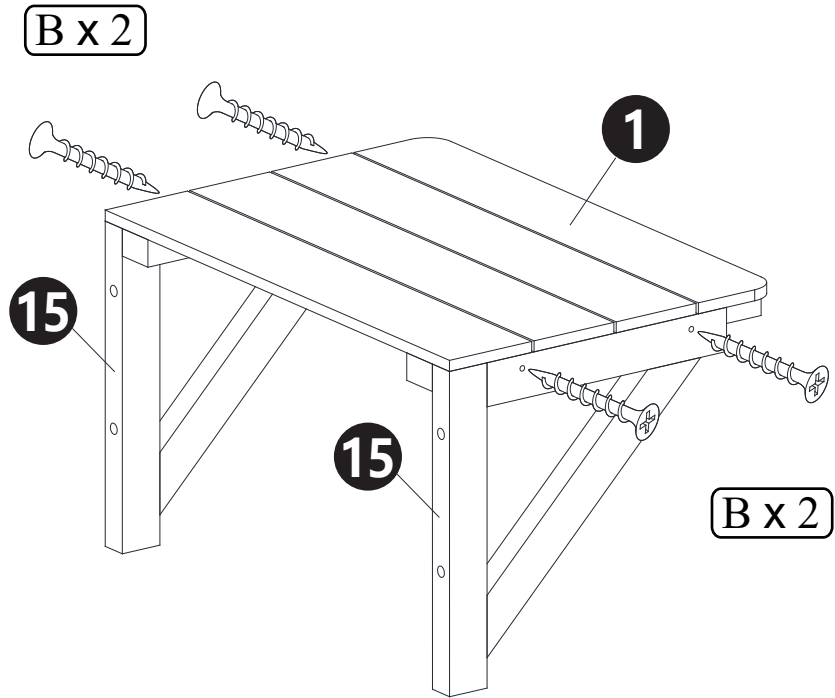
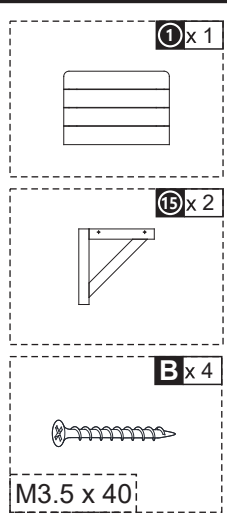

01

x6

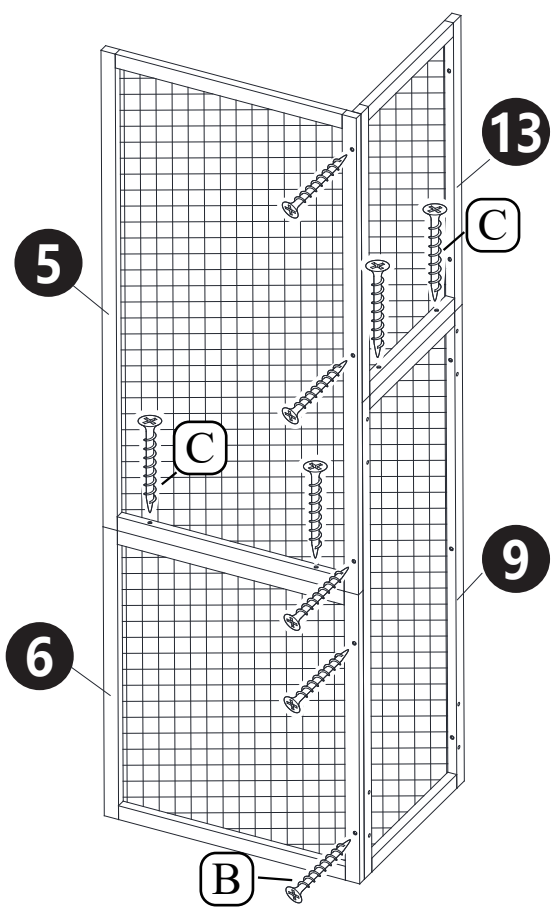
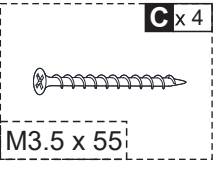
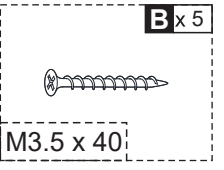
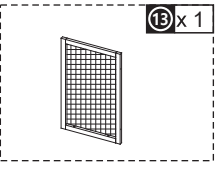
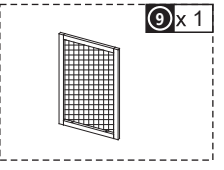
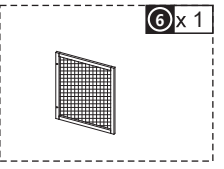
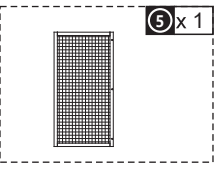
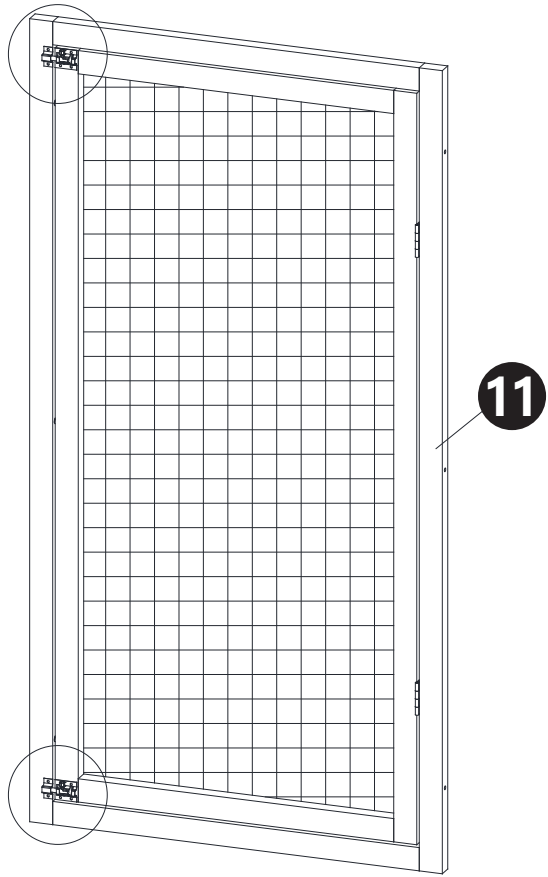
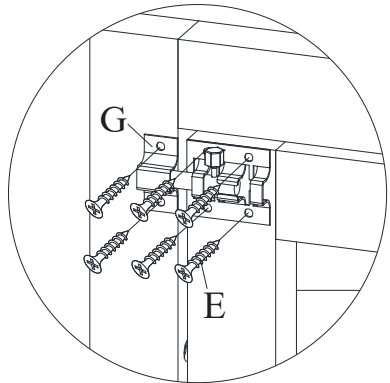
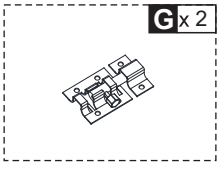
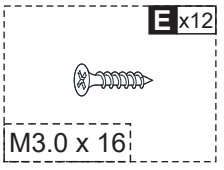
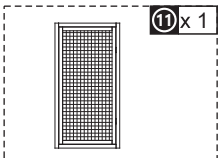

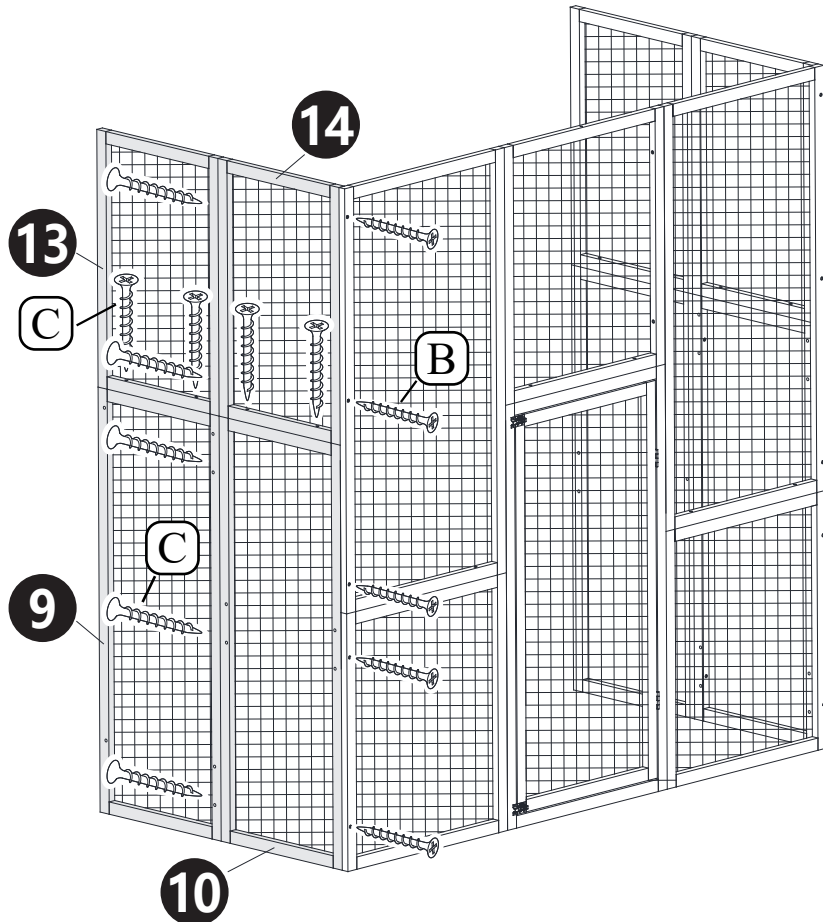
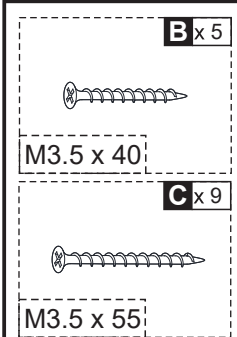
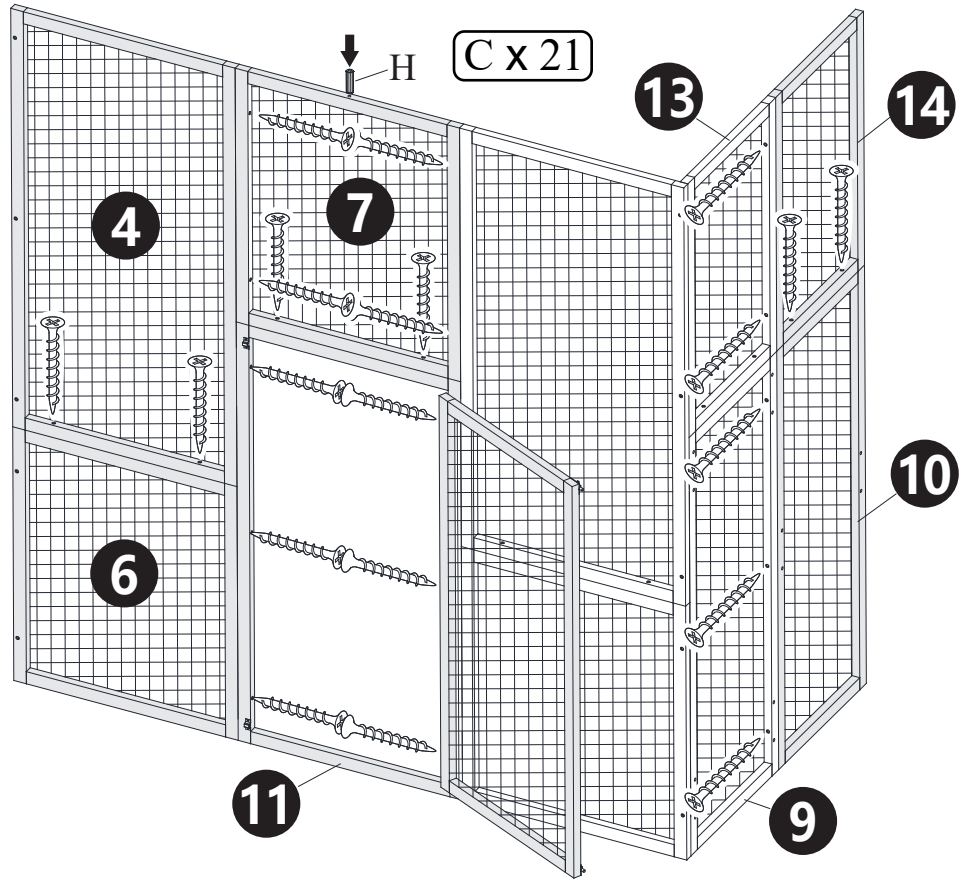
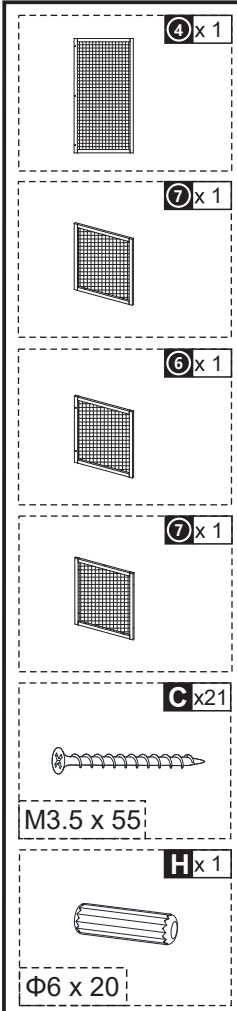

F x24



M6.0 x 60

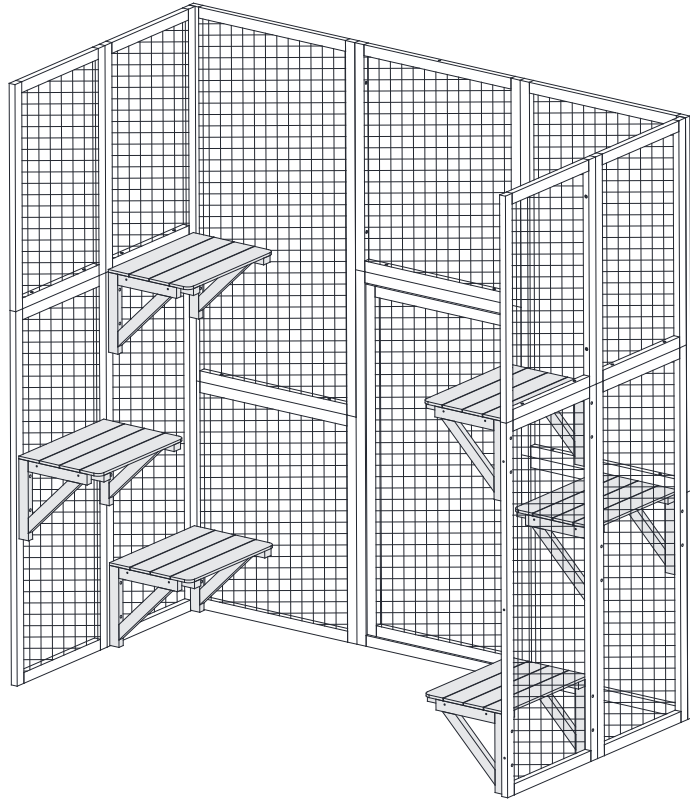
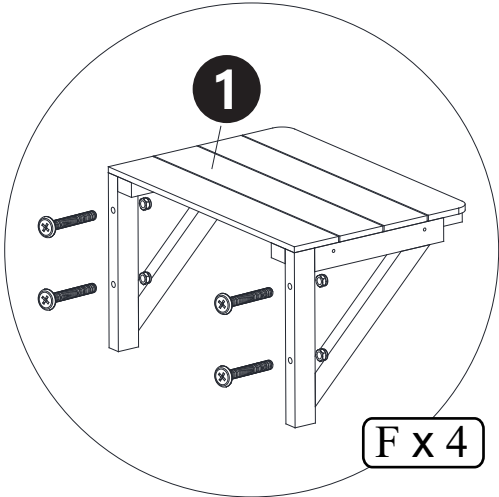

12 x 1

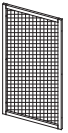

B x10



M3.5 x 40

C x16



M3.5 x 55

H x 1



Φ6 x 20

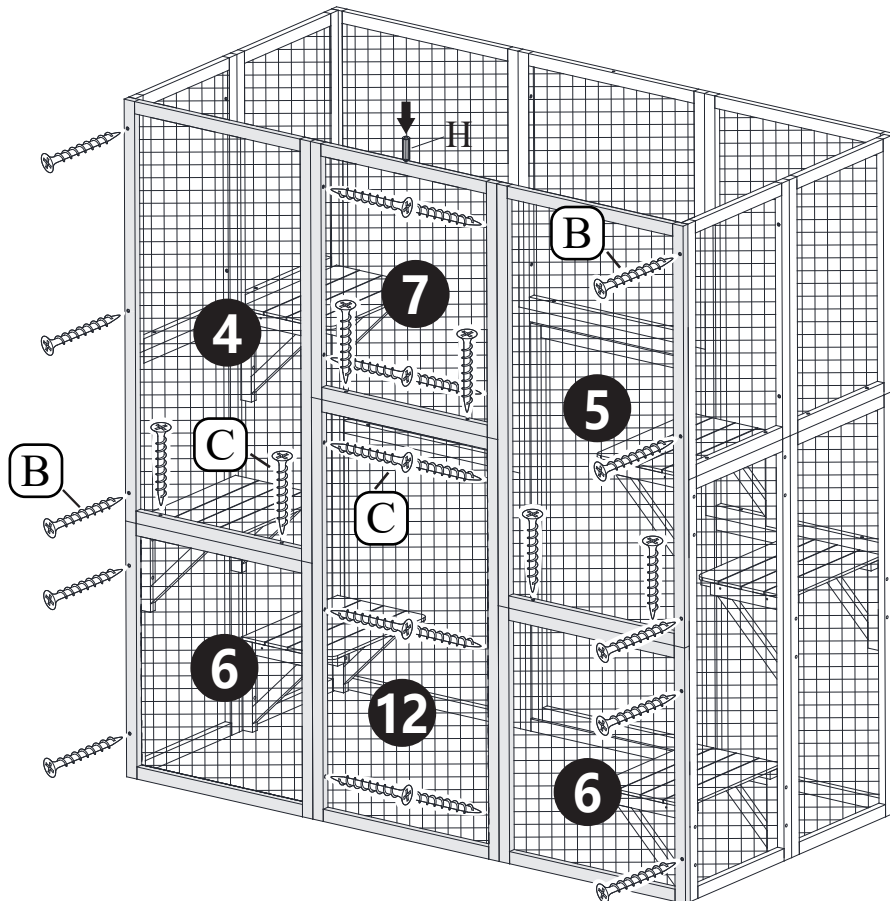

2 x 1

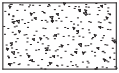

3 x 2

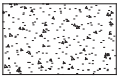

A x 20



M3.5 x 30

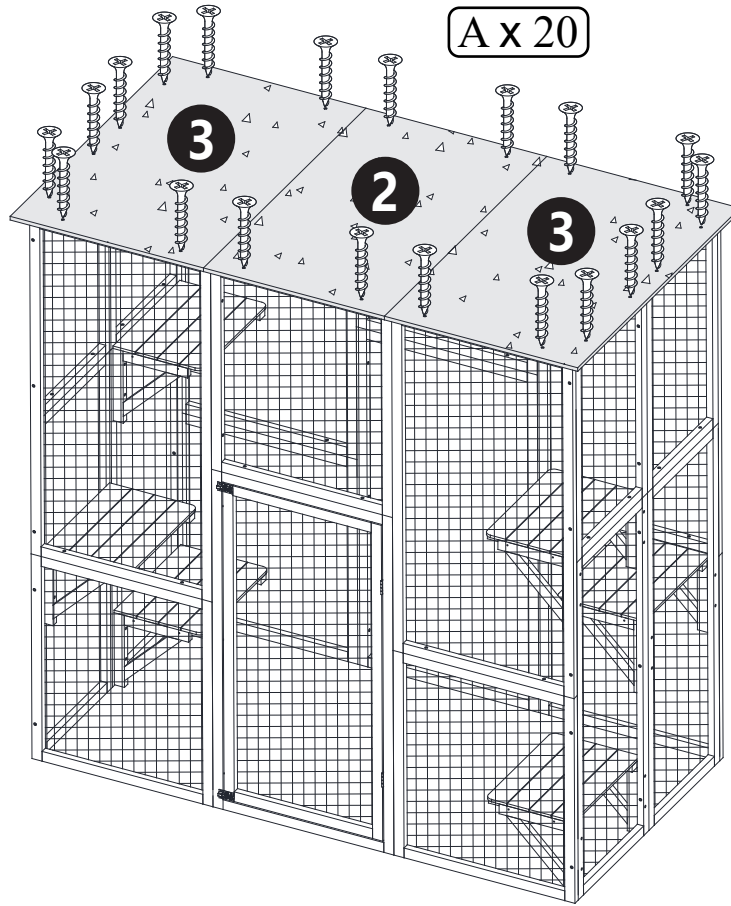

8 x 2

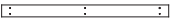

D x 12



M3.0 x 20

