

# Owner Manual

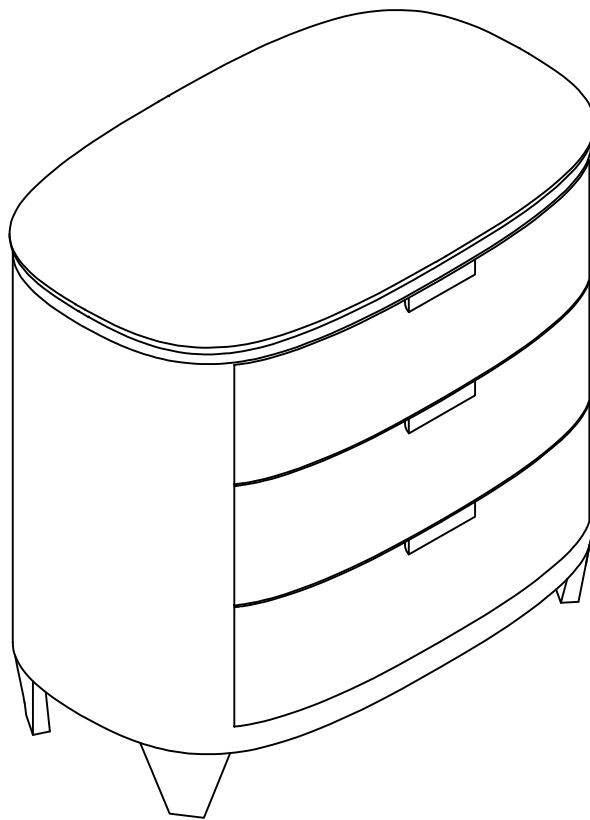

Per Seat Weight Limitation

**80 LBS**

---

Thank You For Choosing Our Furniture

- ▀ If you have any questions or concerns, don't hesitate to reach out to us. ▴

**NOTE:**





This brochure contains **IMPORTANT** safety info. Please read and keep it for future reference.

# MAINTENANCE AND WARNINGS



## Before You Start

### *Please follow the steps below:*

-  Check the packaging for any damage, deformation, or water stains. If there is significant damage, please contact us promptly.
-  Open the packaging and confirm that the panels, hardware, screws, etc are complete.
-  Please read the installation instructions carefully to understand the installation steps and precautions to ensure proper installation.
-  Clean the installation area in advance and ensure the ground is level and there is enough space to avoid damaging the furniture or making installation difficult.
-  Lay a protective mat on the ground to prevent scratching the floor during installation.

### ***After-Sales Service***

- If you encounter any issues or need technical support during use, please contact our after-sales team. We offer long-term maintenance and warranty services.



## Precautions

- ⚠ This product for indoor use only. Do not expose it to outdoor elements or high-humidity environments.
- ⚠ Keep the product away from high heat or open flames to prevent fire hazards.
- ⚠ Do not allow children to climb on the product to prevent personal injury caused by tipping





## Safety Warnings

- ⚠ If you notice any loose or damaged parts, stop using the product immediately and contact customer service.
- ⚠ Do not attempt to disassemble or replace any components yourself, as this may affect the stability and safety of the product.

### ***Daily Maintenance***

- Regularly clean the surface of the sofa with a soft cloth to prevent dust accumulation.
- Do not use cleaning agents containing acids, alkalis, or corrosive substances, as they may damage the surface. It is recommended to use neutral cleaning agents or specialized furniture cleaners
- Avoid exposing furniture to humid environments for extended periods to prevent swelling or deformation of the boards. Use a dehumidifier or desiccant during humid weather.
- Avoid direct contact of furniture with water. If water is accidentally spilled, wipe it dry immediately.
- Avoid placing excessively heavy objects on the furniture: ensure the weight is within a reasonable load-bearing range.
- Avoid using sharp or rough items on the furniture surface to prevent scratches, Handle items gently when moving them

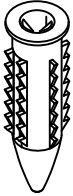
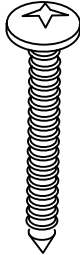
# Hardware List

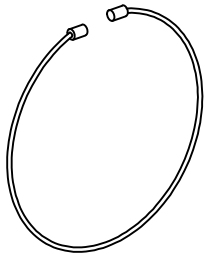
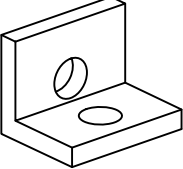
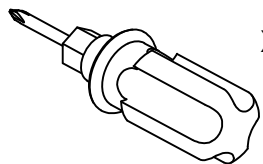
<p>1</p>  <p>x2</p>	<p>2</p>  <p>x2</p> <p>D3.5x38mm</p>	<p>3</p>  <p>x2</p> <p>D3.5x16mm</p>
<p>4</p>  <p>x2</p>	<p>5</p>  <p>x4</p>	<p>6</p>  <p>x1</p>

# Step 1



Attention:  
Before the next step, adjust the feet of  
the locker to keep it level.

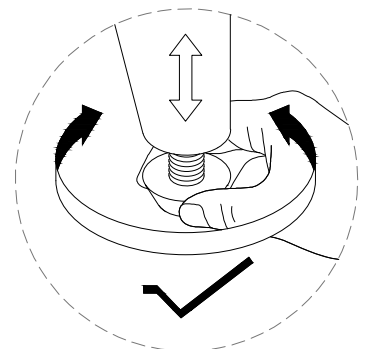
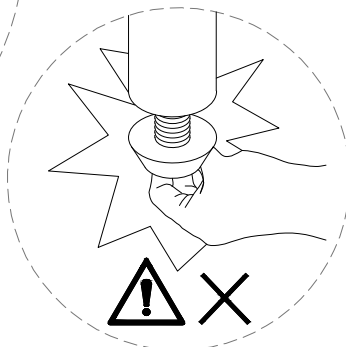
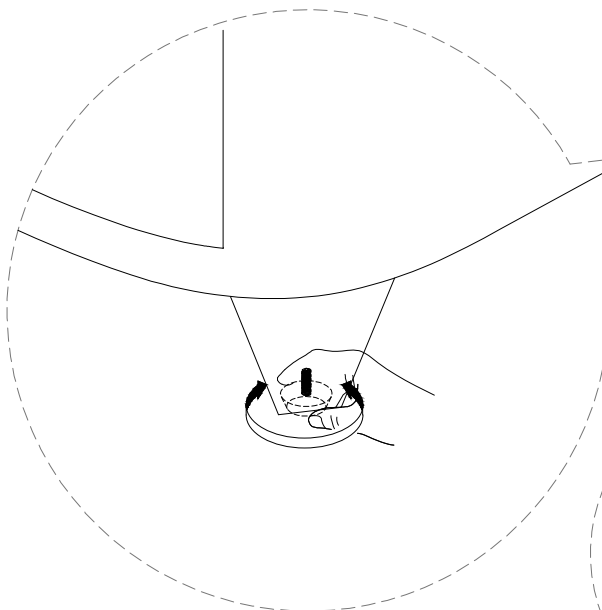
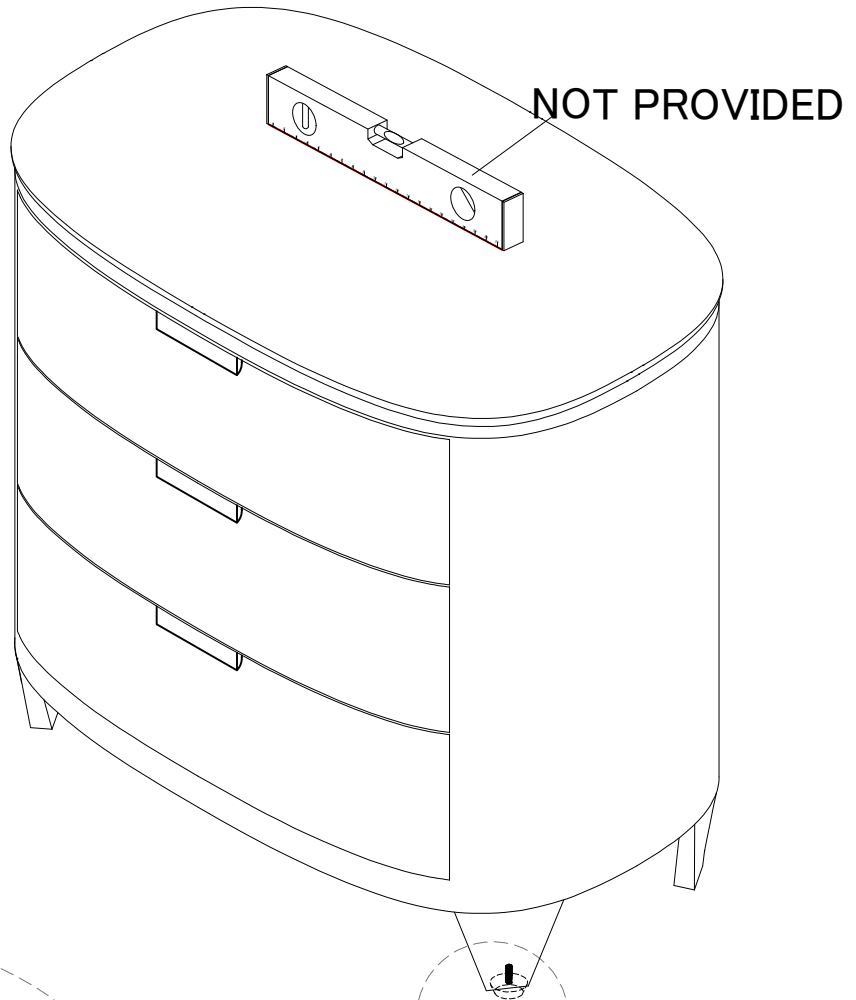

## Step 2

Use screw #3 to attach part #5 to the back of the nightstand, tight screw with screwdriver #6.

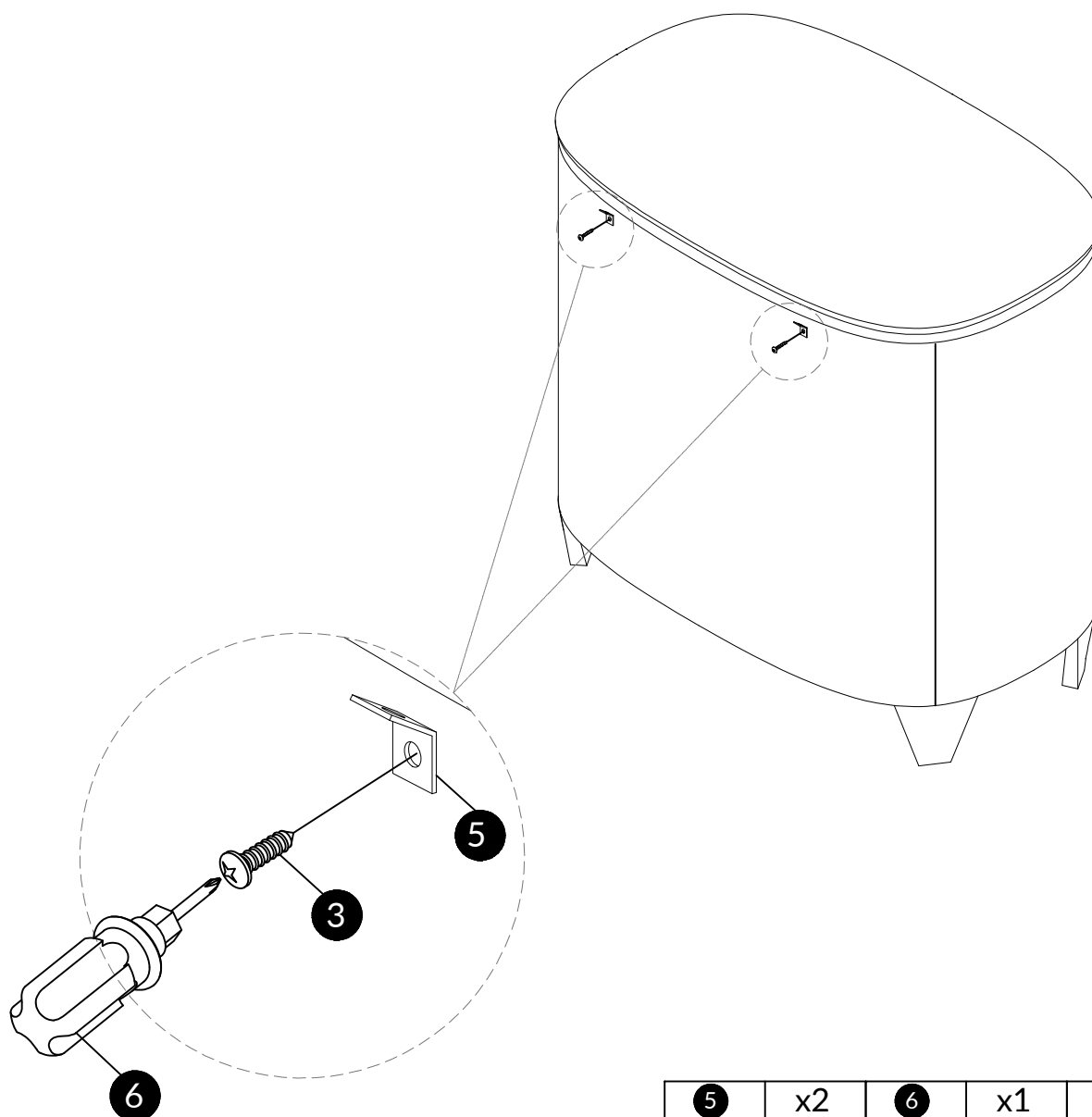

5	x2	6	x1	3	x2
					D3.5x16mm

## Step 3

1. Install the anti-collapse device.

2. Mark the position on the wall, that corresponds to the location of part #5 on the back of the nightstand; Drill and insert the expandable screw #1 by hammer.

3. Assemble the part #5 to the wall. Align the hole in the part #5 with the expandable screw #1, use screw #2 to attach it and tighten by screwdriver #6.

NOT PROVIDED

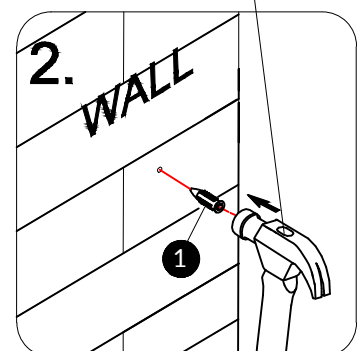
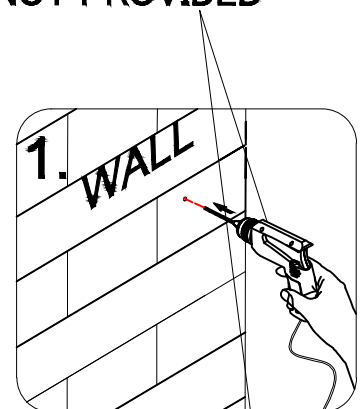
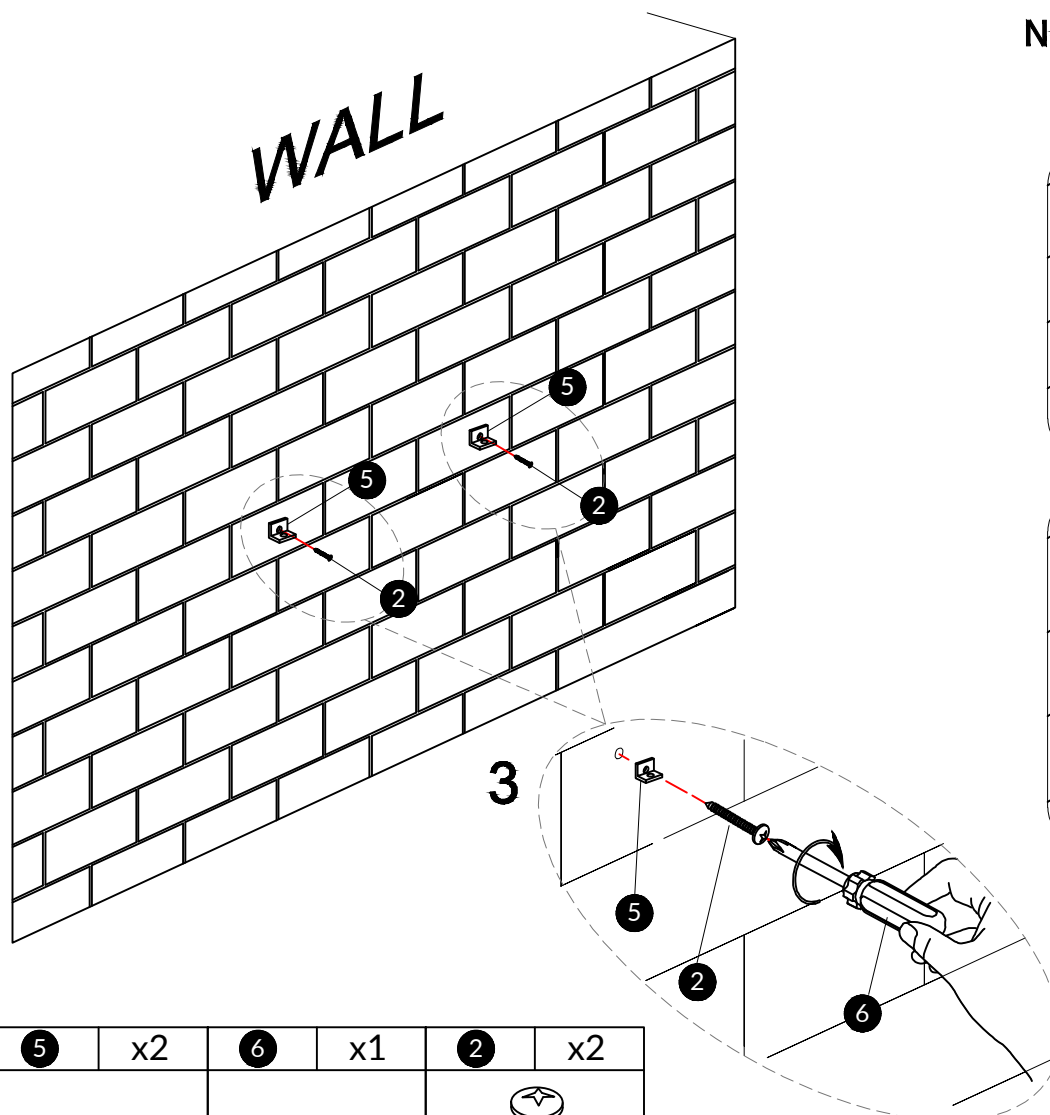

5	x2	6	x1	2	x2
				D3.5x38mm	

1	x2

## Step 4

1. Let the steel belt #4 pass through the both part #5 and lock it .

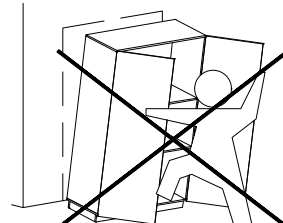
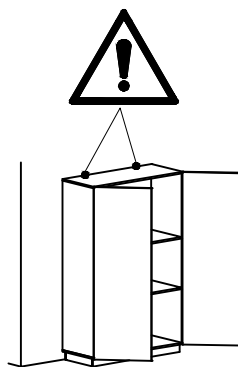
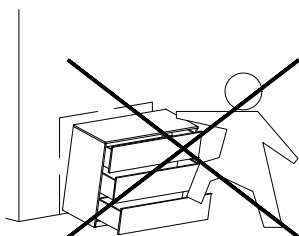
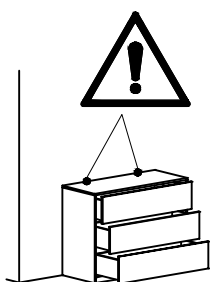
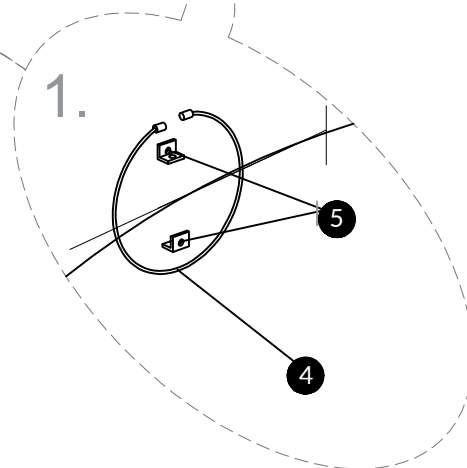
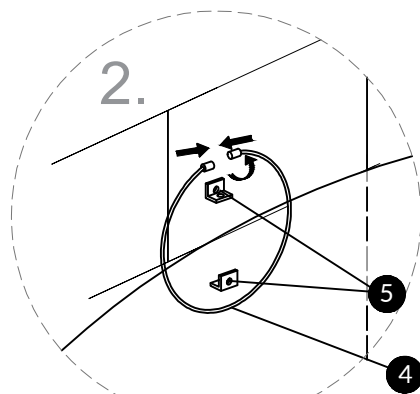
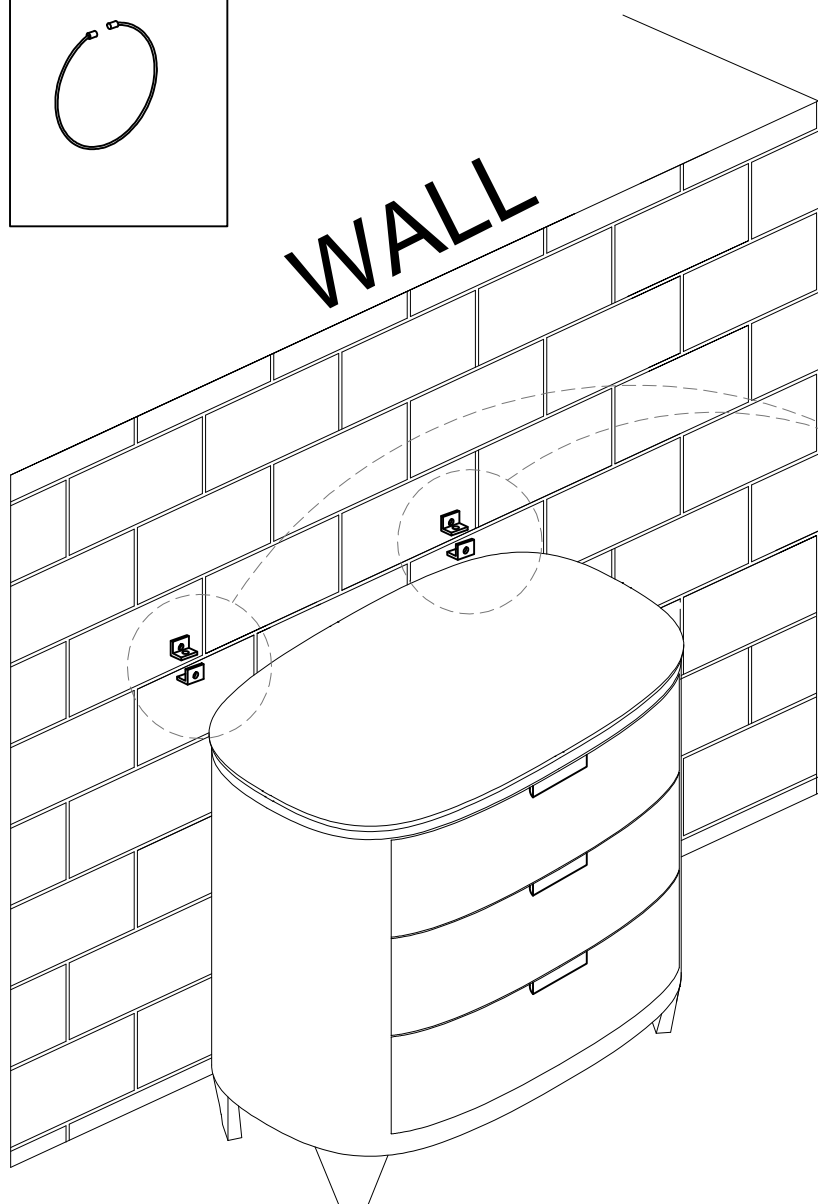
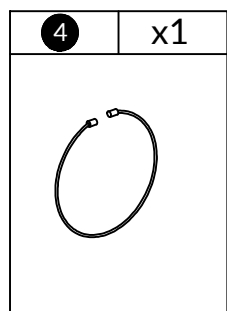

# WARRANTY

- We strive to offer quality products, and we also try our best to satisfy every customer who orders from us with products or services as needed.
- We provide 30 days warranty starting from the time you receive the item. Each customer must provide a record of their orders such as the order number, or item receipt for any items that are out of the warranty period you may also still receive.
- Replacement parts by purchasing them from our company if they are available.
- For return, please check the return policy with the retailer or market place you bought.