

MODEL:IG10600047-1111

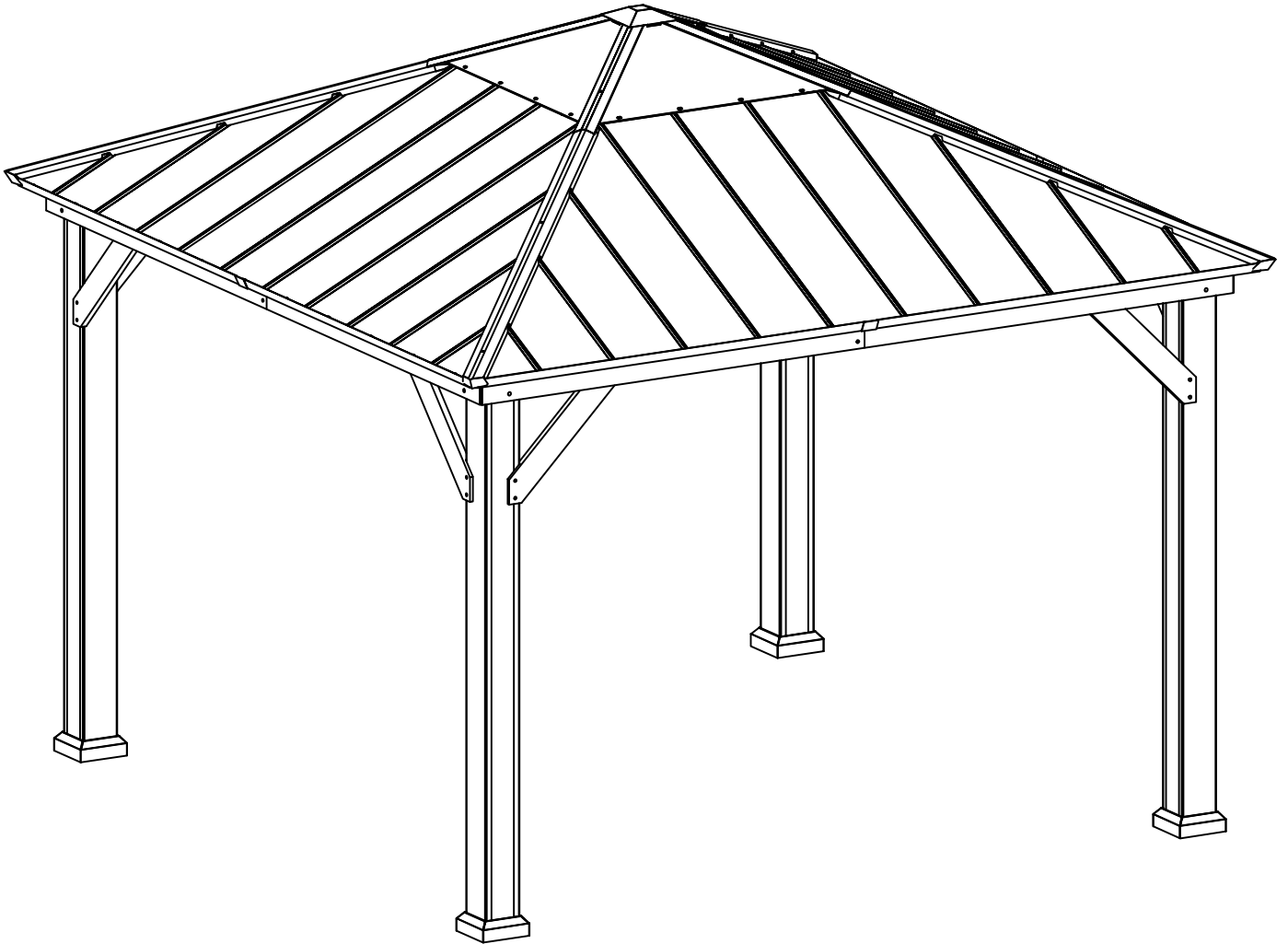

OWNER'S MANUAL

Tranquil Grove 11' x 11' Cedar Framed Hardtop Pavilion

TABLE OF CONTENTS

ASSEMBLY GUIDE.....02
USING YOUR PRODUCE.....04

May 20, 2024

QUESTIONS?











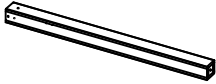
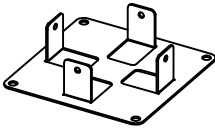
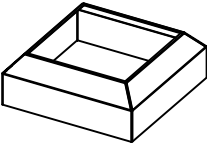
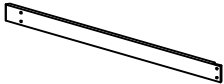
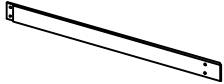
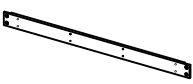
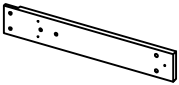
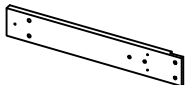

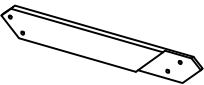

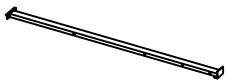

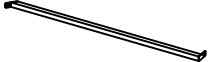
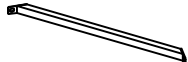

 **E-mail:** support@modernshade.org

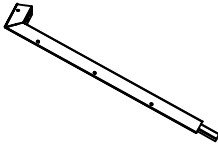
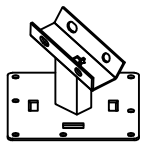
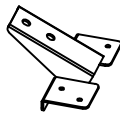
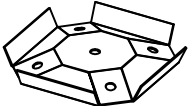
 **Toll Free:** 1-888-666-3070

 **Mon-Fri:** 9:00 ---17:00 PST.

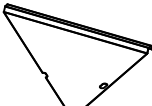
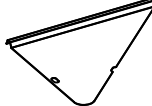
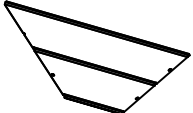
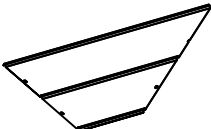
ASSEMBLY GUIDE

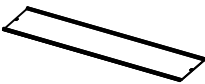
PARTS LIST

A Post (4 Piece) 	B Foot Base (4 Piece) 	C Foot Cover (4 Piece) 	D1 Cross Beam 1 (4 Piece) 	D2 Cross Beam 2 (4 Piece) 	D3 Cross Beam 3 (4 Piece) 
P0008008754	P0008008755	P0008008756	P0008008757	P0008008758	P0008008759
D4 Cross Beam 4 (4 Piece) 	D5 Cross Beam 5 (4 Piece) 	E1 Support Bracket 1 (4 Piece) 	E2 Support Bracket 2 (4 Piece) 	F1 Roof Rib 1 (4 Piece) 	F2 Roof Rib 2 (4 Piece) 
P0008008760	P0008008761	P0008008762	P0008008763	P0008008764	P0008008765
G Middle Cross Beam (4 Piece) 	H1 Mosquito Net Rod 1 (4 Piece) 	H2 Mosquito Net Rod 2 (4 Piece) 	J1 Roof Support 1 (8 Piece) 	J2 Roof Support 2 (8 Piece) 	J3 Roof Support 3 (4 Piece) 
P0008008766	P0008008767	P0008008768	P0008008769	P0008008770	P0008008771
K1 Roof Border 1 (4 Piece) 	K2 Roof Border 2 (4 Piece) 	L Roof Top Border (4 Piece) 	M1 Connector 1 (4 Piece) 	M2 Connector 2 (4 Piece) 	M3 Connector 3 (1 Piece) 
P0008008772	P0008008773	P0008008774	P0008008775	P0008008776	P0008008498
N1 Roof Rib Cover 1 (4 Piece) 	N2 Roof Rib Cover 2 (4 Piece) 	N3 Roof Rib Cover 3 (1 Piece) 	P1 Roof Plate 1 (4 Piece) 	P2 Roof Plate 2 (4 Piece) 	P3 Roof Plate 3 (4 Piece) 
P0008008778	P0008008779	P0008008780	P0008008781	P0008008782	P0008008783
P4 Roof Plate 4 (4 Piece) 	P5 Roof Plate 5 (4 Piece) 	P6 Roof Plate 6 (4 Piece) 	P7 Roof Plate 7 (4 Piece) 	P8 Roof Plate 8 (4 Piece) 	Q Hook (1 Piece) 
P0008008784	P0008008785	P0008008786	P0008008787	P0008008788	P0008008594

ASSEMBLY INSTRUCTIONS

•Please carefully unpack each of the components and hardware, check the components against the parts list and make sure there are no missing parts. lay pieces on cardboard or a soft mat to help protect the pieces from scratches.

⚠ CAUTION

Watch for sharp edges when handling the pieces, wear gloves to avoid injury.

STEP 01 Slide Foot Cover **[C]** onto the bottom of Post **[A]**. Attach Foot Base **[B]** to Post **[A]** with one (1) M5x25 Bolt **[AA]** on each side. Slide the Foot Cover **[C]** down to cover the Foot Base **[B]**. Repeat this process to make three (3) more posts.

[AA] x 16

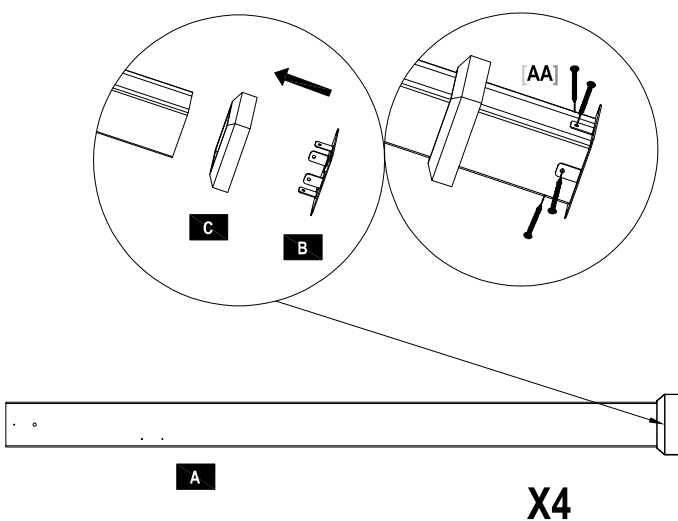

- For ease of assembly, it is recommended to have 3 or more people and allow enough time to completely finish the assembly. assembly can take 6-8 hours. a step-ladder is required for assembly (not included).
- Follow step by step instructions, and follow all safety warnings provided with your tools.
- DO NOT tighten screws until all the screws and washers are properly installed. tighten screws securely, do not over tighten.
- Gazebo should not be used in inclement weather and high winds.

STEP 02 Connect Cross Beam 1 **[D1]** to Cross Beam 2 **[D2]** using two (2) M8x8 Four Claw Screw Nuts **[KK]** on the front side, and two (2) M8x25 Bolts **[GG]** and two (2) M8 Flat Washers **[MM]** on the other side. Repeat this process to make three (3) more assemblies.

[GG] x 8
[KK] x 8
[MM] x 8

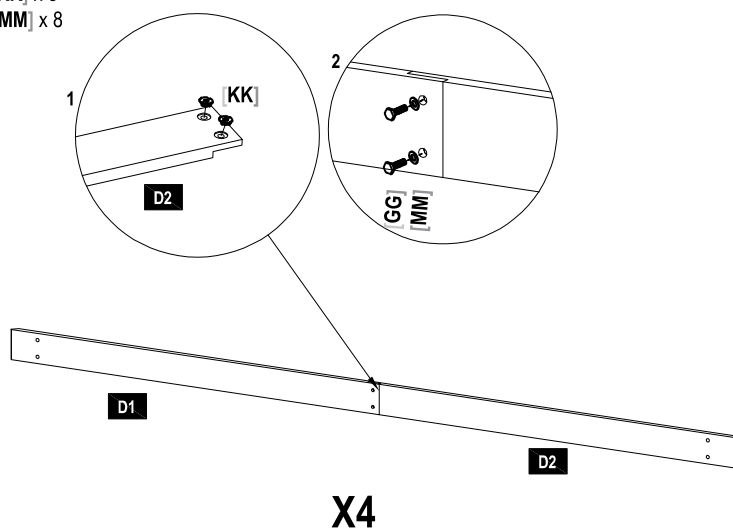

STEP 03 Insert two (2) M8x8 Four Claw Screw Nuts **[KK]** into the front side of Cross Beam 3 **[D3]** on both ends. Repeat on the other three (3) assemblies.

Insert two (2) M8x8 Four Claw Screw Nuts **[KK]** into the holes on the back of all Cross Beam 4s **[D4]** and Cross Beam 5s **[D5]**.

[KK] x 32

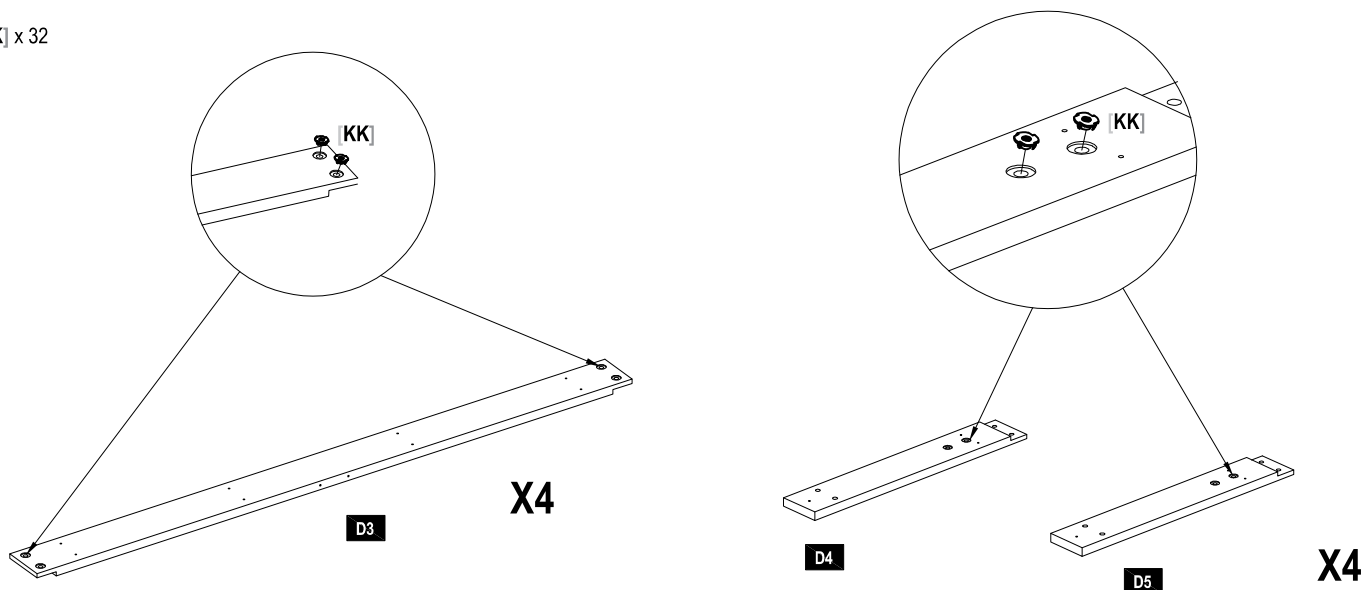

STEP 04 Attach one (1) Cross Beam 5 [D5] to each end of Cross Beam 3 [D3] using one (1) M8x25 Bolt [GG] and one (1) M8 Flat Washer [MM] per hole. Repeat to make another assembly.

Attach one (1) Cross Beam 4 [D4] to each end of Cross Beam 3 [D3] using one (1) M8x25 Bolt [GG] and one (1) M8 Flat Washer [MM] per hole. Repeat to make another assembly.

[GG] x 16
[MM] x 16

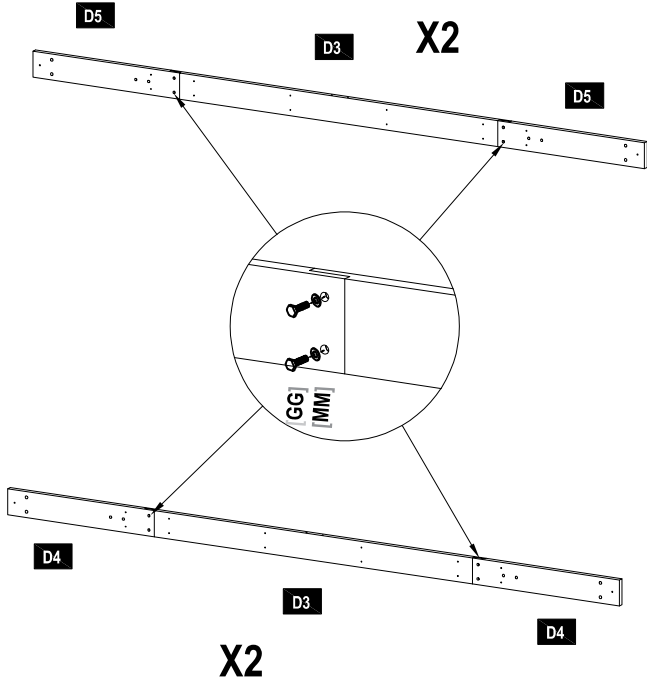

STEP 05 Lay the Cross Beam [D1] + [D2] assembly from step 2 flat. Lay the Cross Beam [D4] + [D3] + [D4] assembly from step 4 on top. Attach the two together with fourteen (14) M5x40 Screws [BB]. Repeat to make another side panel assembly.

[BB] x 28

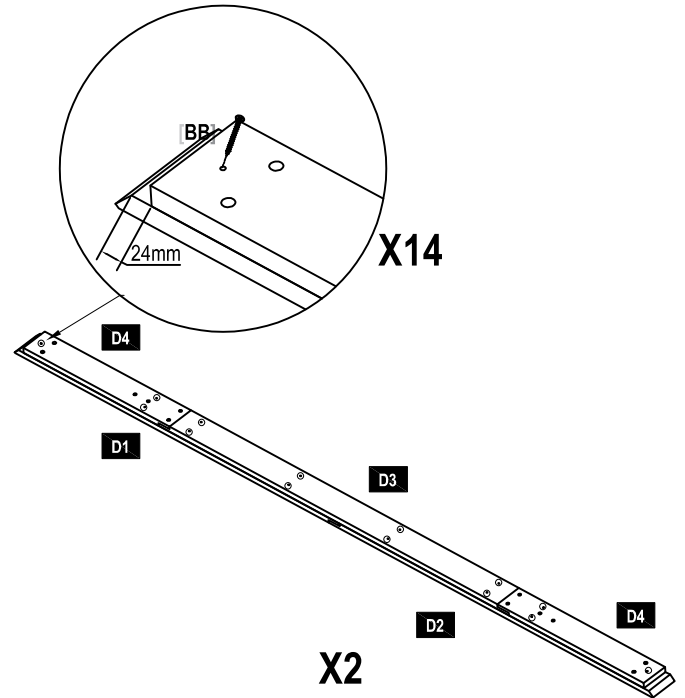

STEP 06 Lay the Cross Beam [D1] + [D2] assembly from step 2 flat. Lay the Cross Beam [D5] + [D3] + [D5] assembly from step 4 on top. Attach the two together with fourteen (14) M5x40 Screws [BB]. Repeat to make another side panel assembly.

STEP 07 Attach Cross Beam assembly [D5] from step 6 to two (2) Posts [A]. Position the side with Cross Beam 1 [D1] on the left. Attach using one (1) M10x80 Bolts [DD], one (1) M10x205 Bolts [HH], three (3) M10 Flat Washers [NN] and one (1) M10 Anti-Slip Screw Nuts [JJ] on one end. Repeat with the other end.

Repeat the entire process to make the other side of the gazebo.

[BB] x 28

[DD] x 4
[HH] x 4
[JJ] x 4
[NN] x 12

