

Features

- 36" minimum base cabinet width.
- Single bowl.
- 9" (229 mm) depth provides generous workspace.
- Five oversized faucet holes.
- Sink drain with strainer sold separately.

Material

- KOHLER® enameled cast iron.
- Acid-resistant enamel finish.

Installation

- Undermount.
- Oversized holes allow for easy installation of faucets and accessories.

Recommended Products/Accessories

- K-6063 Sink Rack
- K-8801 Sink drain and strainer with tailpiece
- K-8799 Sink drain and strainer basket
- K-6637 Cutting Board
- K-23726 Drain treatment
- K-23725 Cast iron cleaner
- 1411886 Undermount sink kit 23"

Optional Products/Accessories

- K-11352 Disposal Flange with Stopper
- K-9000 P-Trap



Codes/Standards













ASME A112.19.1/CSA B45.2

KOHLER® Enameled Cast Iron Kitchen Sink Lifetime Limited Warranty

See website for detailed warranty information.

Available Colors/Finishes

Color tiles intended for reference only.

Color	Code	Description
	0	White
	FF	Sea Salt™
	96	Biscuit
	47	Almond
	NY	Dune
	95	Ice™ Grey
	K4	Cashmere
	FT	Basalt
	58	Thunder™ Grey
	R1	Roussillon™ Red
	FP	Caviar
	7	Black Black™

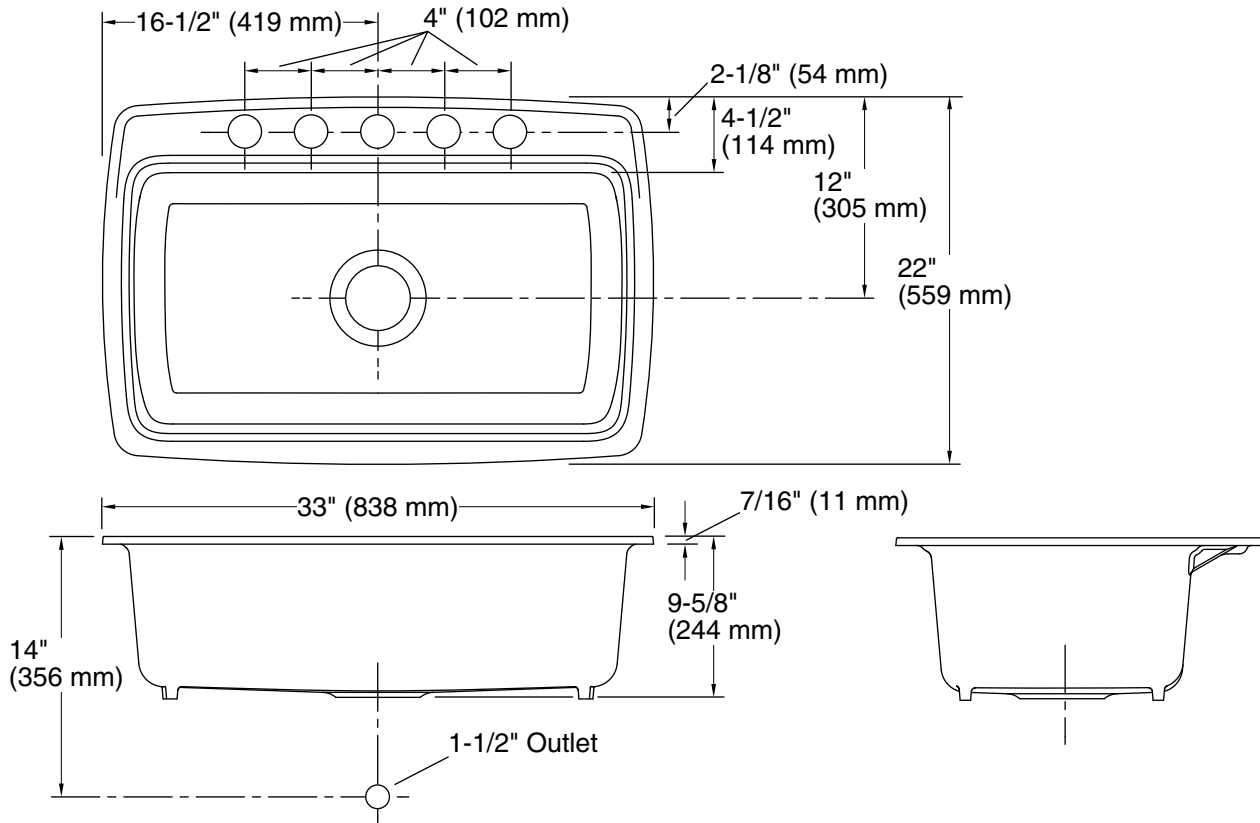

Technical Information

All product dimensions are nominal.

Bowl configuration:	Single
Installation:	Under-mount
Min. base cabinet width:	36" (914 mm)
Bowl area (Only):	Length: 29" (737 mm) Width: 15" (381 mm) Bowl depth: 9" (229 mm)
Number of deck holes:	5
Faucet hole(s):	2-3/8" (60 mm)
Drain hole:	3-5/8" (92 mm)
Template:	Under-mount, 1034873-7, required, included

Notes

Install this product according to the installation instructions.

Faucet holes in under-mount fixture are oversized at $\sim 2\text{-}3/8"$ (60 mm). Drill faucet holes in counter according to fitting roughing-in.