

NEU180 series

(Including NEU180, NEU181, NEU181A, NEU182A, NEU182B, NEU188, NEU188A, NEU185, etc.)

Upright vacuum cleaner; household type

Owner's Guide

Thank you for purchasing your new Eureka vacuum!

Important instructions

For easy assembly, please take a few moments to read this owner's guide.

If you have questions about your new vacuum, please contact our customer service HELPLINE at 1-800-282-2886.

We're here to help!



Eureka stands by our Clean Promise seal.

Learn more at

www.eureka.com/cleanpromise

www.eureka.com



eureka

Where to find important vacuum information

Keep this information

Write the model, type and serial number here:

Date of purchase (keep your receipt) _____

Model number and type _____

Serial number _____

Find these numbers on a label on the middle back side of the vacuum cleaner. Refer to these numbers when ordering parts and accessories or if service is needed.

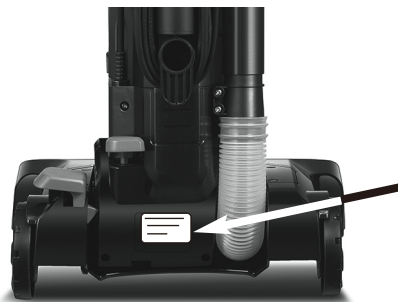

This Owner's Guide provides important instructions to prolong the life of your Eureka vacuum cleaner.

Registration: To register your product visit www.eureka.com and click on the 'Register Your Product' link in the top right corner.

Inspection: Carefully unpack and inspect your new Eureka vacuum cleaner for shipping damage. Each unit is tested and thoroughly inspected before shipping. For instructions regarding any shipping damage, call the Eureka Customer Service **HELPLINE** at **1-800-282-2886** immediately.

Contents

Important safeguards.	3
What comes in the carton	4
How to assemble your vacuum cleaner.	5
How to identify parts of your vacuum cleaner	6
How to use your vacuum cleaner	7
How to use accessories.	8
How to maintain dust cup and filters	9
How to clear a blockage	10
How to maintain brushroll	11
How to replace brushroll or belt.	12
Thermal cut-off and problem solving.	13
The Eureka limited warranty	14
How to order replacement parts	15

 Follow caution information wherever you see this symbol.

IMPORTANT SAFEGUARDS

When using an electrical appliance, basic precautions should always be followed, including the following:

READ ALL INSTRUCTIONS BEFORE USING THIS VACUUM CLEANER

WARNING



To reduce the risk of fire, electric shock, or injury:

- Do not use outdoors or on wet surfaces.
- **Do not leave vacuum cleaner when plugged in.** Turn off the switch and unplug the electrical cord when not in use and before servicing.
- Do not allow to be used as a toy. Close attention is necessary when used by or near children.
- Use only as described in this manual. Use only manufacturer's recommended attachments.
- Do not use with damaged cord or plug. If vacuum cleaner is not working as it should, has been dropped, damaged, left outdoors, or dropped into water, call the Eureka Customer Service **HELPLINE** at **1-800-282-2886**.
- Do not pull or carry by cord. Do not use cord as a handle. Do not close a door on cord or pull cord around sharp edges or corners. Do not run vacuum cleaner over cord. Keep cord away from heated surfaces.
- Do not use extension cords or outlets with inadequate current carrying capacity.
- Turn off all controls before unplugging.
- Do not unplug by pulling on cord. To unplug, grasp the plug, not the cord.
- Do not handle plug or vacuum cleaner with wet hands.
- Do not put any objects into openings. Do not use with any openings blocked; keep free of dust, lint, hair, and anything that may reduce airflow.
- This vacuum cleaner creates suction and contains a revolving brush roll. Keep hair, loose clothing, fingers, and all parts of body away from openings and moving parts.
- Do not place vacuum cleaner on furniture or stairs as the brush roll may cause damage. Use extra care when cleaning stairs. Place vacuum cleaner on floor with the handle in storage position while using attachments.
- Do not pick up anything that is burning or smoking, such as cigarettes, matches, or hot ashes.
- Do not use without dust cup, filter and screen in place.
- Belt pulleys can become hot during normal use. To prevent burns, avoid touching the belt pulley when servicing the drive belt.
- Do not use to pick up flammable or combustible liquids such as gasoline, or use in areas where they may be present.
- Store your vacuum cleaner indoors in a cool, dry area.
- Keep your work area well lit.
- Unplug electrical appliances before vacuuming them.
- **WARNING:** This product can expose you to chemicals including Styrene, which is known to the State of California to cause cancer, and Bisphenol-A, which is known to the State of California to cause birth defects or other reproductive harm. For more information go to www.P65Warnings.ca.gov.

SAVE THESE INSTRUCTIONS

To reduce the risk of electric shock, this appliance has a polarized plug (one blade is wider than the other). This plug will fit in a polarized outlet only one way. If the plug does not fit fully into the outlet, reverse the plug. If it still does not fit, contact a qualified electrician to install the proper outlet. Do not change the plug in any way.



Motor

Do Not Oil the motor or the brush roll at any time. The bearings are permanently lubricated and sealed.

What comes in the carton

The below parts and accessories are included in all NEU180 series.
NEU180, NEU181, NEU181A, NEU182A, NEU182B, NEU185, NEU188, NEU188A, etc.

Parts



Hose



Handle



Upper Cord Hook



Lower Cord Hook

Accessories



Dusting brush



Upholstery tool



Crevice tool

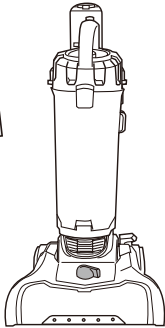

Vacuum cleaner

The below additional accessory is also included with models:
NEU181, NEU181A, NEU188, NEU188A, etc.



Pet Turbo Brush

The below additional accessories are also included with models:
NEU188, NEU188A



Flexible telescoping crevice tool

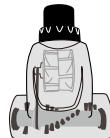

Pet Turbo Brush



2-in-1 upholstery tool

Accessories may vary depending on which model was purchased.

How to assemble your vacuum cleaner

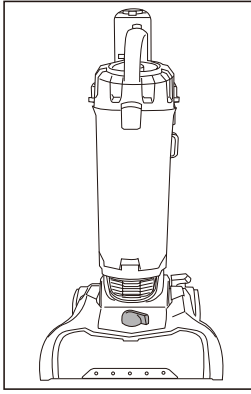

Vacuum cleaner with dust cup.

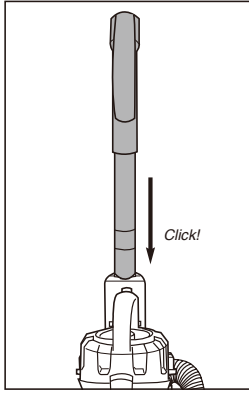

Slide handle into top of vacuum cleaner. Push down until it clicks.

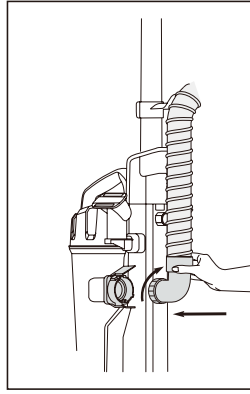

Insert bent end of hose into opening at back of dust cup. Twist hose clockwise to lock.

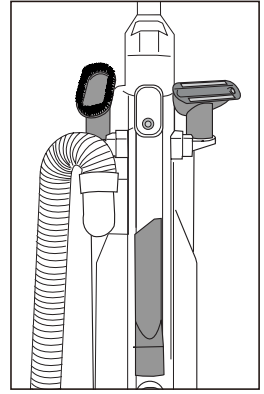

Store accessories on back of vacuum cleaner.

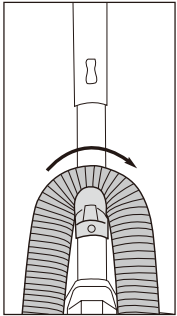

Loop hose over hose retainer.

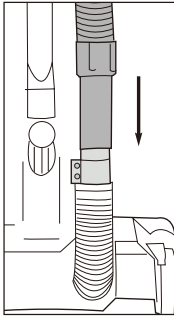

Push loose end of hose securely onto hose inlet.

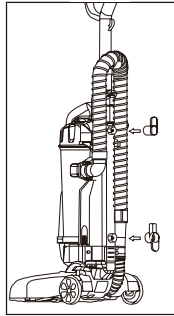

Align upper and lower cord hooks and press to snap in place. Upper cord hook should rotate freely.

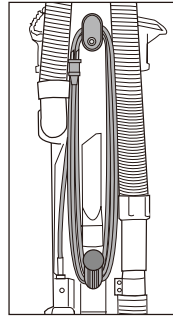

Wrap cord onto upper and lower cord hooks.

Select models only
(NEU182-NEU188
except NEU182A)

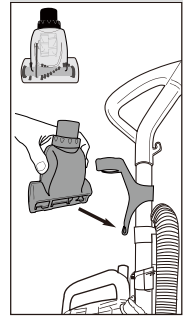

Store turbo brush on front of handle. Align brush opening with slot and push to snap tool into clip.

How to identify parts of your vacuum cleaner

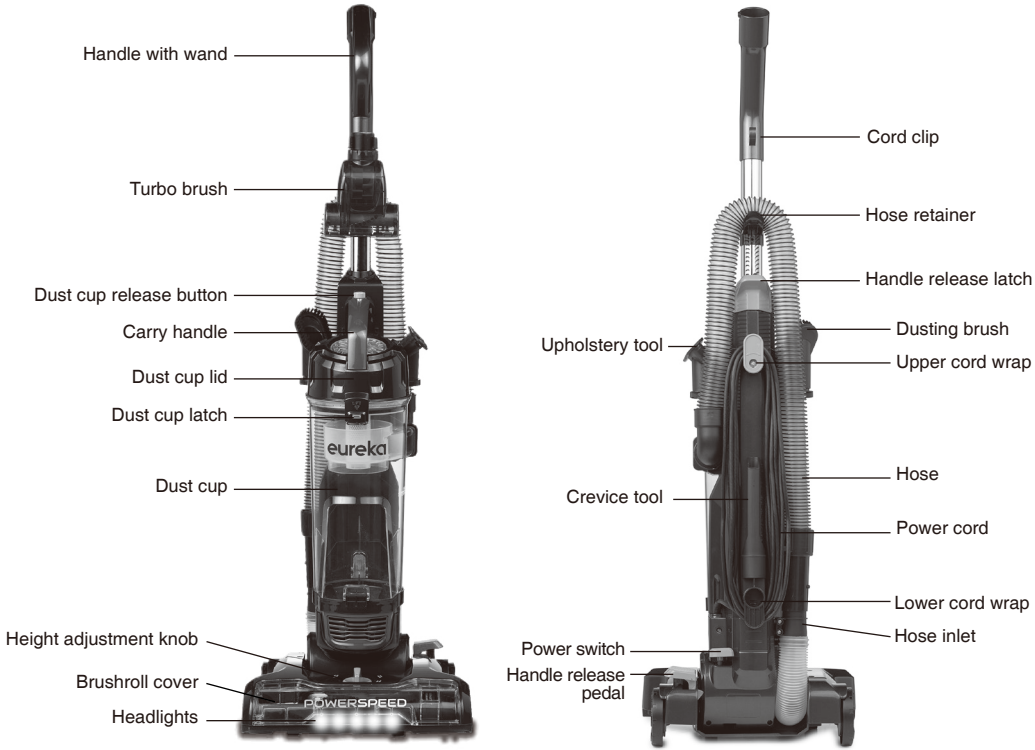

Headlights are included on select models only (NEU188, NEU188A). Accessories may vary depending on which model was purchased.

For filter maintenance instructions, see page 9

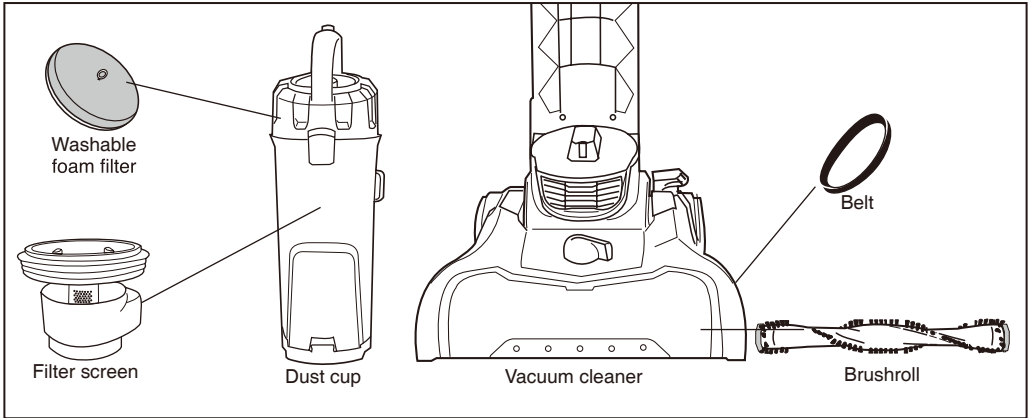

How to use your vacuum cleaner

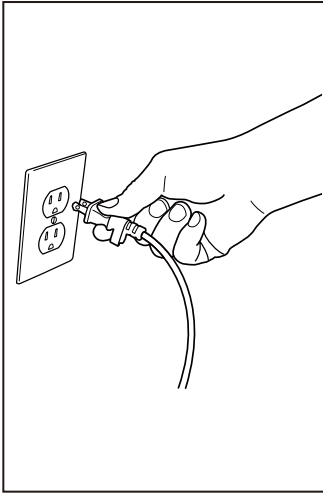

Plug power cord into outlet.

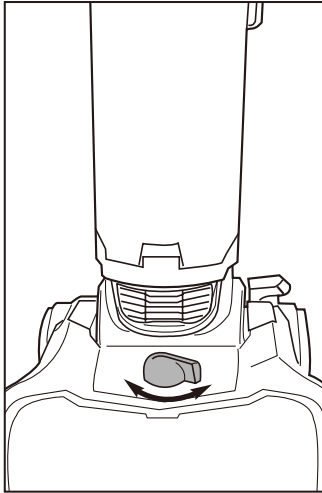

Turn height adjustment knob to adjust from bare floors to high pile carpet.

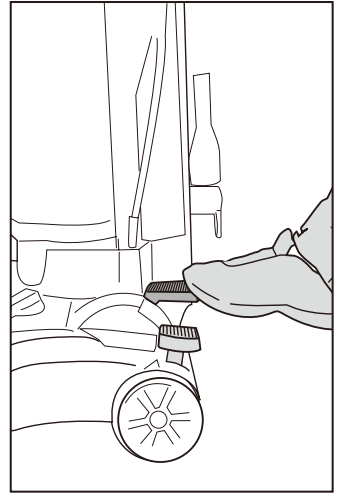

Step on power switch to turn vacuum cleaner on. Step on again to turn off.

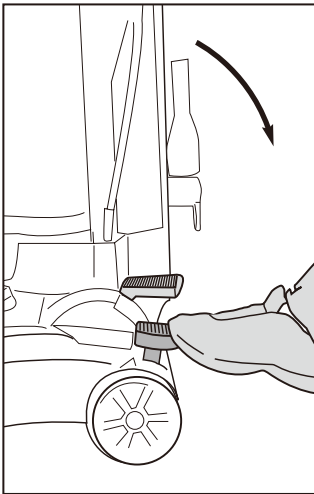

Step on handle release to lower handle into position for vacuuming floors.

Empty dust cup after every use

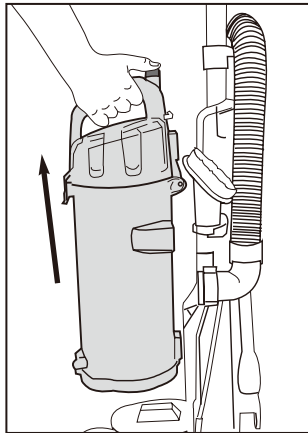

Press release button and lift off dust cup.

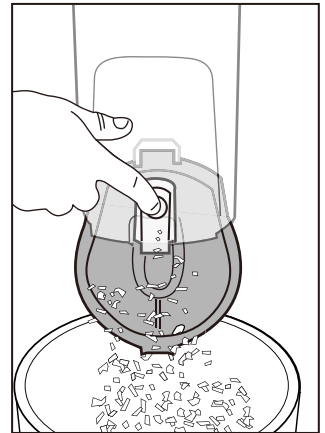

To empty debris, press lever to release bottom lid.

How to use accessories

CAUTION

When using tools, always place handle in upright position. Make sure vacuum cleaner is turned off while attaching tools.

- Place vacuum in upright position.
- Turn height adjustment knob to highest position.
- Pull up on hose connection to release hose end from hose inlet (Fig. 1).
- Push end of hose into top of handle and twist clockwise until it clicks (Fig. 2).
- Press handle release latch and pull out handle with wand (Fig. 3).
- To attach accessories, push desired tool onto end of wand (Fig. 4).
- To use accessories without handle and wand, push desired tool directly onto end of hose (Fig. 5).
- When finished using accessories, twist hose counterclockwise and pull off handle. Slide handle into top of vacuum cleaner and push down until it clicks. Push loose end of hose securely onto hose inlet. Store tools on vacuum cleaner back. (See page 5.)

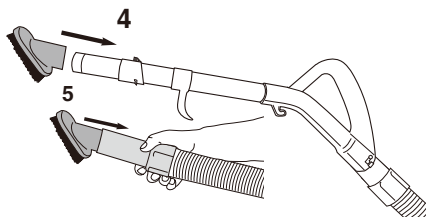
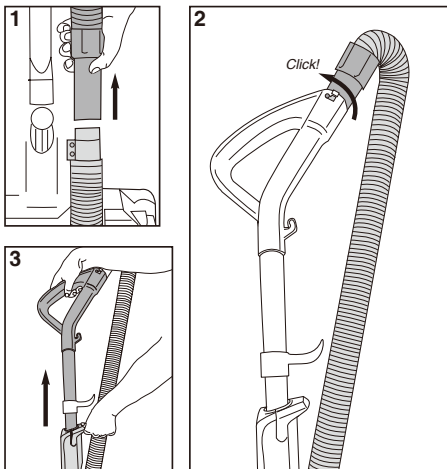

Crevice tool (NEU180, NEU181, NEU181A, NEU182A, NEU182B, NEU185, etc.) -

Use for baseboard edges, corners, detailing chairs, sofas, dryer vents and tight spaces.



Upholstery tool (NEU180, NEU181, NEU181A, NEU182A, NEU182B, NEU185, etc.) -

Use for furniture, chairs, sofas and mattresses.

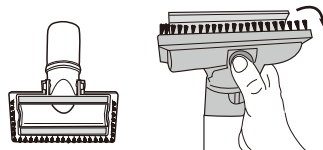

2-in-1 upholstery tool (NEU188) -

Use brush to vacuum upholstered surfaces or pick up debris. Use felt portion to clean delicate surfaces. Press thumb release and lift brush up and out of the way.

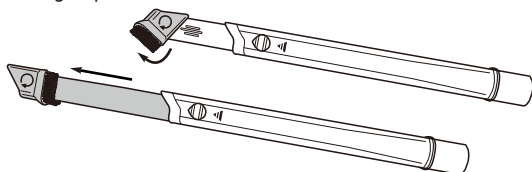

Flexible telescoping crevice tool (NEU188) - Press button and pull to extend tool to desired length. To use brush, pull to swivel into position. Use for baseboards, crevices and tight spaces.



Dusting brush (NEU180, NEU181, NEU181A, NEU182A, NEU182B, NEU185, etc.) -

Use for furniture, drapes, blinds, drawers and vents.

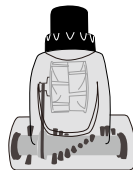

Turbo brush (NEU181, NEU181A, NEU188, NEU188A) -

Use to remove pet hair from stairs, carpet and upholstery.

Accessories may vary depending on which model was purchased.

How to maintain dust cup and filters

Dust cup – Empty after each use

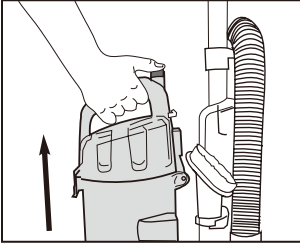

Press release button and lift off dust cup.

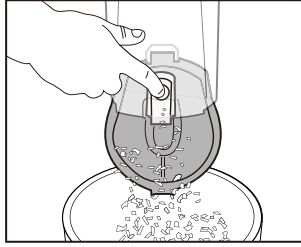

Hold dust cup over wastebasket and press lever to release bottom lid. Debris will empty.

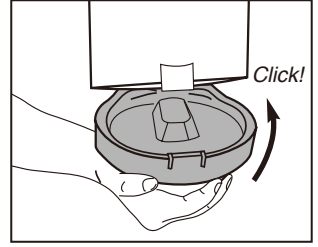

Close bottom lid until it clicks.

Washable dust cup filters – Clean monthly

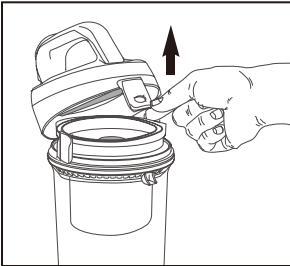

Pull dust cup latch to lift up dust cup lid.

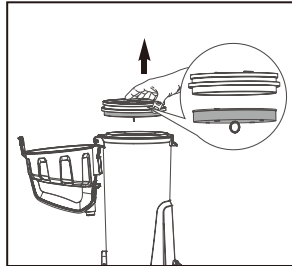

Lift out foam filter and shake off dust. Rinse foam filter and dry THOROUGHLY.

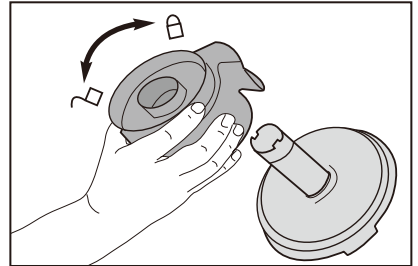

Grip tabs and lift out filter screen. Twist bottom of filter screen counterclockwise to unlock and pull apart. Shake off dust. Rinse screen and dust cup. Dry all THOROUGHLY. Reassemble screen; twist clockwise to lock.

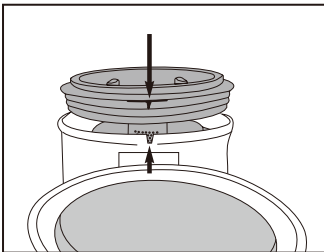

Align tab on filter screen with slot on back of dust cup and drop into position.

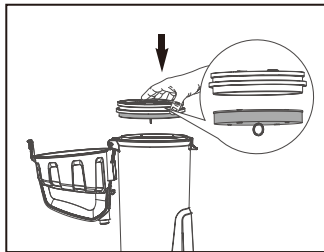

Reinstall foam filter.

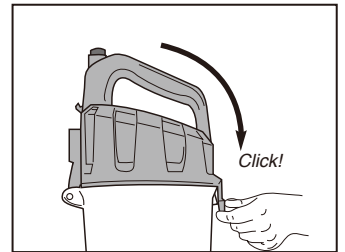

Close cover until it clicks.



Warning: Never operate vacuum cleaner without foam filter, filter screen and dust cup in proper position.

How to clear a blockage

⚠ CAUTION

Make sure vacuum is turned off and power cord is unplugged.

If vacuum is not cleaning floors, or if no suction at end of hose, check to be sure air path is not blocked.

- Press release button and lift off dust cup (Fig. 1).
- Empty debris. Hold over wastebasket and press lever to release bottom lid (Fig. 2).
- Check filter and filter screen. Remove any debris and shake off dust. (See maintenance instructions on page 9.)
- Loosen end of hose.
- Use a rod or similar blunt implement to clear a blockage in wand or hose. Flex hose to loosen debris (Fig. 3). Use caution if there is any risk that glass or nails could have become imbedded in hose.
- Use finger to check for debris in air path (Fig. 4).
- Reinstall filter and filter screen inside dust cup and position dust cup onto vacuum cleaner.

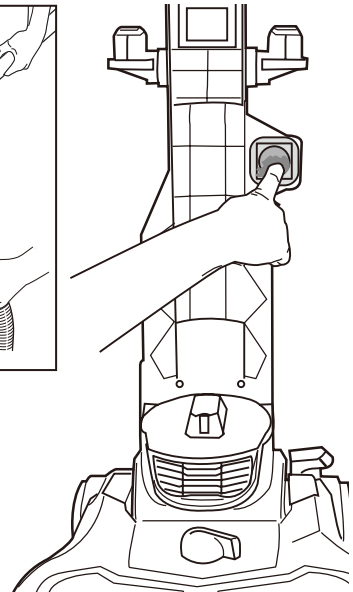
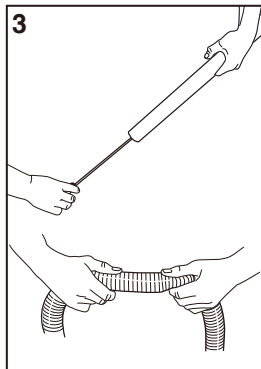
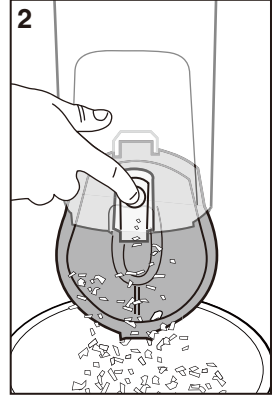
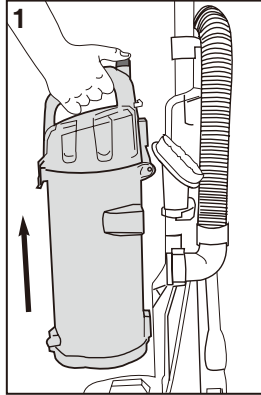

⚠ Warning: Never operate vacuum cleaner without foam filter, filter screen and dust cup in proper position.

How to maintain brushroll

⚠ CAUTION

Make sure vacuum is turned off and power cord is unplugged.

- Step on handle release to lower handle.
- Turn vacuum face down on floor.
- To avoid unnecessary service calls, check brushroll for debris.
- Use scissors to clip heavy threads or strings.

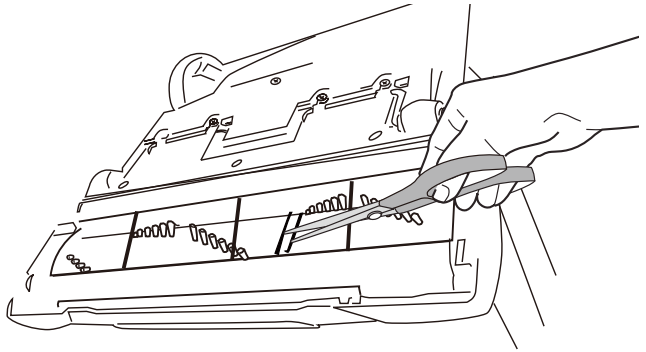
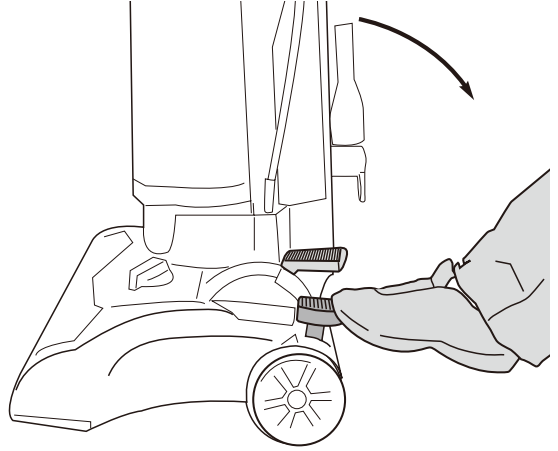

How to maintain turbo brush

Select models only (NEU182-NEU188 except NEU182A)

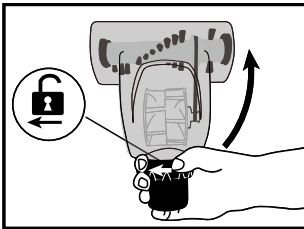

Grasp collar and twist to unlock cover. Lift cover up.

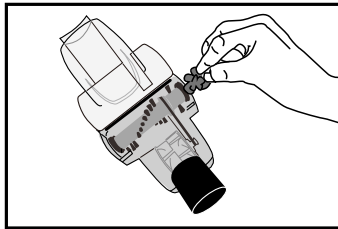

With cover open, use fingers or small brush to clear accumulated pet hair from bristles.

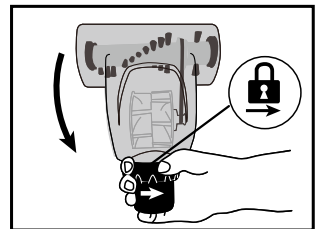

Close cover and twist collar to lock.

How to replace brushroll or belt

⚠ CAUTION

Make sure vacuum is turned off and power cord is unplugged.

- Step on handle release and lay vacuum cleaner face down.
- Use Phillips screwdriver to remove 6 screws from brushroll cover (Fig. 1). Lift off cover. Refer to Fig. 7 for location of screws.
- Rotate right end of brushroll and lift out (Fig. 2).
- Lift out left end of brushroll.
- To replace belt, position new belt around motor shaft (Fig. 3).
- Loop new belt around brushroll shaft at left end of brushroll (Fig. 4).
- To reposition brushroll into base, pull belt down and insert left end of brushroll first. Align brushroll end cap with slot so it fits into position (Fig. 5). Press right end of brushroll into position.
- To replace brushroll cover, align slot on cover with tab (Fig. 6) and snap cover into place. Replace 6 screws (Fig. 7).

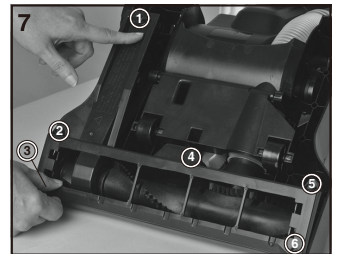
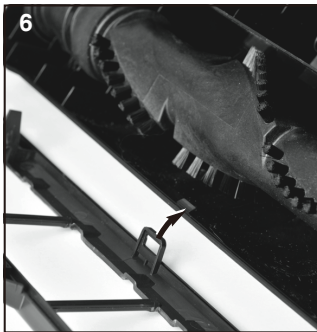
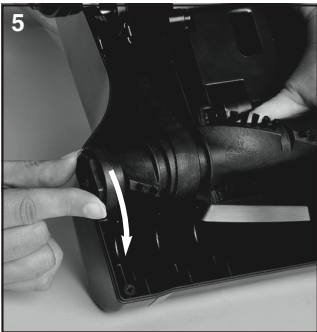
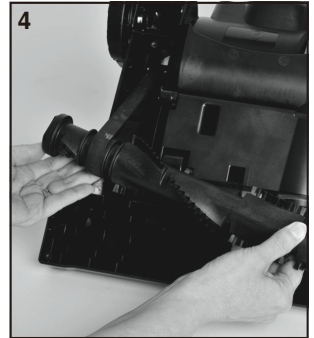
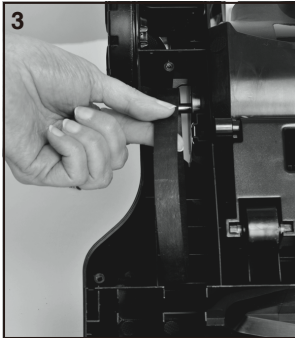
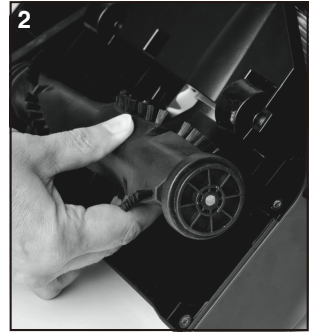
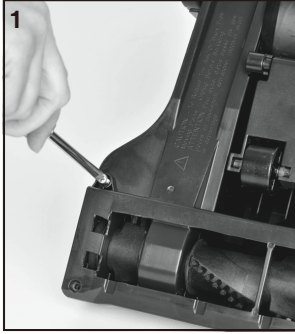

Problem solving



Make sure vacuum is turned off and power cord is unplugged.

NOTICE : Thermal cut-off

This vacuum cleaner has a special thermostat that protects the vacuum in case of motor overheating.

If the vacuum suddenly shuts off, proceed as follows: 1) Push the power switch to off and unplug the vacuum. 2) Check the vacuum for a possible source of overheating such as a full dust cup, blocked hose or clogged filter. If these conditions are found, fix them and wait at least 30 minutes before attempting to use the vacuum. 3) After the 30 minute period, plug the vacuum back in and turn on the switch. If the vacuum still does not work, call the Eureka Customer Service **HELPLINE** at **1-800-282-2886**.

Problem	Solution
Motor will not start.	<ul style="list-style-type: none">• Push plug securely into outlet, try another outlet or check circuit breaker.• Step on power switch to turn vacuum on.• See detailed “thermal cut-off” instructions above.
Vacuum cleaner does not clean floors.	<ul style="list-style-type: none">• Empty dust cup, clean and/or change filter.• Clean or replace filter regularly to maintain suction.• Check vacuum height adjustment knob position.• Clean brushroll if needed. Page 11.
No suction at the end of hose or wand.	<ul style="list-style-type: none">• See other solutions above.• Remove clogs from the hose or wand that restrict the airflow. Page 10.
Burning smell; brushroll will not turn.	<ul style="list-style-type: none">• Check brushroll for debris.• Replace broken or out of shape belt. Page 12.
Vacuum is hard to push.	<ul style="list-style-type: none">• Adjust vacuum height knob to a higher position.• Check brushroll for debris and clean if needed. Page 11.
Turbo brush will not turn (select models: NEU182-NEU188 except NEU182A).	<ul style="list-style-type: none">• Check turbo brush for debris. Page 11.

The Eureka two-year limited warranty

Midea America Corp. (“Eureka”), subject to the terms and conditions herein, warrants this vacuum cleaner to be free from defects in material and workmanship for a term of two years from the date of original purchase when used in accordance with the Eureka operating and maintenance instructions and under normal household usage. This warranty is granted only to the original purchaser and members of immediate household, and is applicable only to original purchases from Eureka authorized resellers.

What Eureka will do:

Eureka will, at its option, repair or replace a defective vacuum or vacuum part that is covered by this warranty. Repairs may be performed using new or refurbished parts that meet or exceed Eureka specifications for new parts. If Eureka elects to replace the vacuum, the replacement may be a reconditioned unit. Depending on availability of products, Eureka reserves the right to provide you with a replacement product that is the same or similar, or substitute equivalent of the original product. As a matter of warranty policy, Eureka will not refund the consumer’s purchase price.

This warranty does not cover:

- Normal wear and tear of the vacuum and vacuum parts that require replacement under normal use such as disposable dust bags, filters, drive belts, light bulbs, brush-roll, bristles, impellers and cleaning.
- Damages or malfunctions resulting from: improper or unreasonable use or maintenance, abuse, negligence, failure to follow instructions contained in any written materials that accompany the product, deterioration by reason of excess moisture, corrosive atmosphere, lightning, power surges, connections to improper voltage supply, unauthorized alteration, or other external causes such as extremes in temperature or humidity, modifications, scratches or discoloration, accidents, misuse, or acts of God. This warranty also does not cover damage resulting from repair or attempted repair by anyone other than Eureka or an authorized Eureka Warranty Station. This warranty is not applicable to any product that has been altered or on which the serial number has been defaced, modified or removed. Altering, erasing, or forging any proof-of-purchase documents voids any applicable product warranty.

Obtaining warranty service:

To obtain warranty service you must contact the Eureka Service Team, toll free, at 1-800-282-2886 or email customerserviceusa@midea.com, to discuss the warranty claim and procedures to be followed. All warranty claims must include submission of proof-of-purchase documentation. For additional information, you may also visit www.eureka.com.

Shipping charges:

You will be responsible for any initial shipping and insurance charges if the defective product(s) must be shipped for warranty service or warranty evaluation; however, Eureka or a Eureka Authorized Warranty Station will pay the return shipping charges if repairs are covered by the warranty. When returning parts for repair, you must include the model, type and serial number located on the rating plate. If any product submitted for warranty service is found to be ineligible, an estimate of repair cost will be furnished and the repair performed only if requested by the owner and upon receipt of payment or acceptable arrangements for payment.







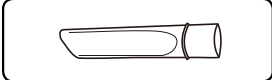

Further limitations and exclusions:

Any warranty that may be implied in connection with your purchase or use of the vacuum, including any warranty of Merchantability or any warranty of Fitness For A Particular Purpose is limited to the duration of this limited warranty. Some states do not allow limitations on how long an implied warranty lasts, so the above limitations may not apply to you.

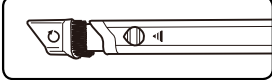
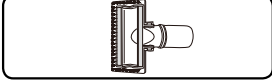
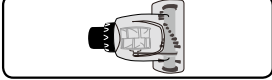
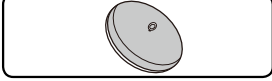
Your relief for the breach of this warranty is limited to the relief expressly provided above. In no event shall the manufacturer be liable for any consequential or incidental damages you may incur in connection with your purchase or use of the vacuum. Some states do not allow the exclusion or limitation of incidental or consequential damages, so the above limitation or exclusion may not apply to you.

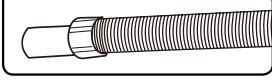
This warranty gives you specific legal rights. You may also have other rights, which may vary by state.

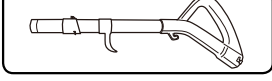
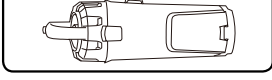
Midea America Corp.
200 Rivers Edge Drive
Medford, MA. 02155
USA

Image	Part name	Part # (Fits models)
	Dusting brush tool	E0101 (all)
	Crevice tool	E0102 (all)
	Upholstery tool	E0201 (all)
	Flexible telescoping crevice tool	S3006 (all)
	2-in-1 upholstery tool	S3007 (all)
	Turbo brush	E0208 (all)
	Washable foam filter	E0202 (all)
	Brushroll	E0203B (all)
	Hose	E0204 (all)
	Belt	E0205 (all)
	Detachable handle	E0206A (NEU180, NEU180C) E0206B (NEU181, NEU182, NEU182CT) E0206C (NEU186) E0206D (NEU187, NEU188) E0206E (NEU188A) E0206F (NEU182A)
	Dust cup	E0207 (NEU180, NEU180C) E0207B (NEU181, NEU182, NEU182CT) E0207C (NEU186) E0207D (NEU187, NEU188)
	Upper and lower hooks	E0601 (all)

Owner's Guide

Do not return to the store, call
Eureka Customer Service
HELPLINE 1-800-282-2886

www.eureka.com



Eureka stands by
our Clean Promise seal.
Learn more at
www.eureka.com/cleanpromise

© 2018 Midea America Corp. Printed in Vietnam 02155180_WMT_rev5

eureka