

# ASSEMBLY INSTRUCTIONS

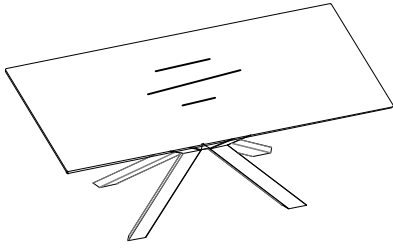

## + Do Not Use PowerTools



## + Suggested Adults

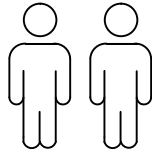

### NOTE:

- 1 Read instructions cover to cover.
- 2 Save all packaging until assembly is completed.

## 1 IMPORTANT SAFETY INFORMATION

**Do not** assemble the product if any of the following parts arrived damaged:

**Part ①** Glass table top

**Part ②** Table base

**Part ③** Connector

**Tempered Glass Warning:** Should the tempered glass chip at ANY point throughout ownership please immediately discontinue use of the table to avoid injury.

**CAUTION:** DO NOT place hot object (100°F or more) directly on the glass surface

## 2 IMPORTANT ASSEMBLY INFORMATION

### Assembly Step 1

Use C,D to connect ③ to ②

### Assembly Step 2

Use B,D to connect ② to ①

## + Parts Included

① Glass table top 1PC

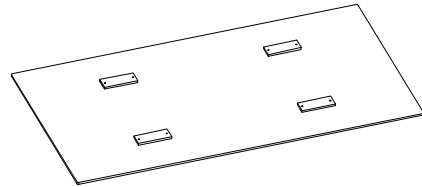

② Table base 2PCS

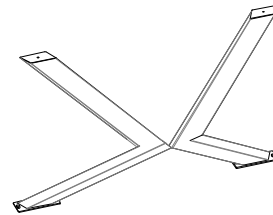

③ Connector 1PC

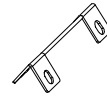

## + Hardware Included

A ALLEN WRENCH 1PC

M8



B BOLT 8PCS

M8\*10MM



C BOLT 4PCS

M8\*15MM



D FLAT WASHER 12PCS

Ø18\*Ø8



# ASSEMBLY INSTRUCTIONS

1

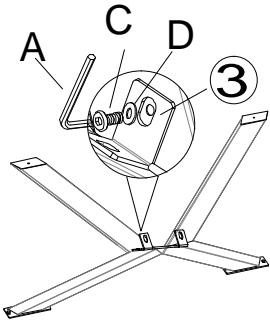

2

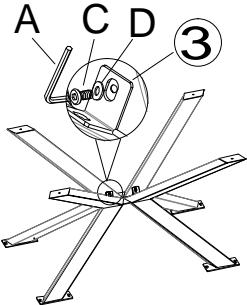

IMPORTANT: BE SURE NOT TO TIGHTEN ALL SCREWS HERE UNTIL YOU CAN ALIGN GLASS AND BASE IN STEP 3

3

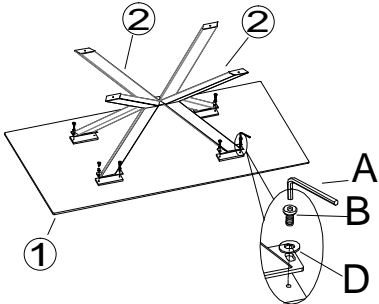

4

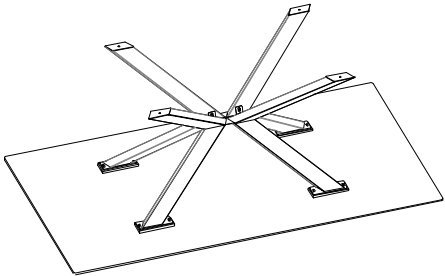

ATTENTION: WHEN YOU ASSEMBLE, PLEASE DON'T TIGHTEN EACH SCREW UNTIL ALL SCREWS ARE LINED UP WITH THE FRAME.