

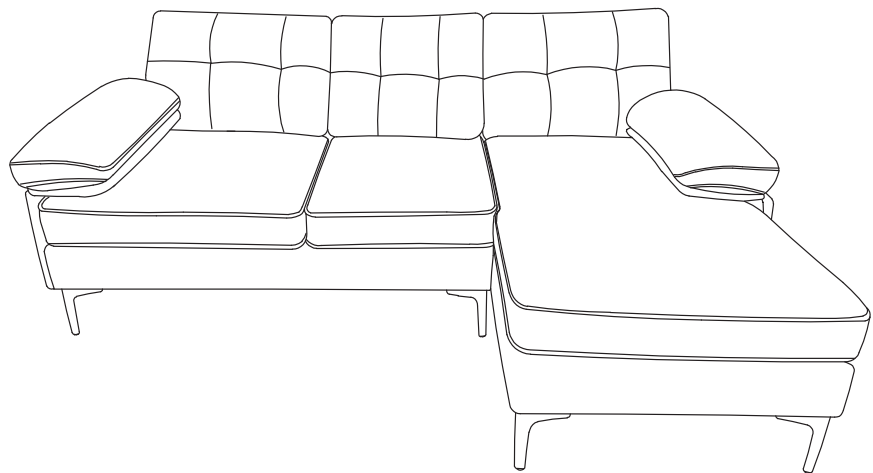

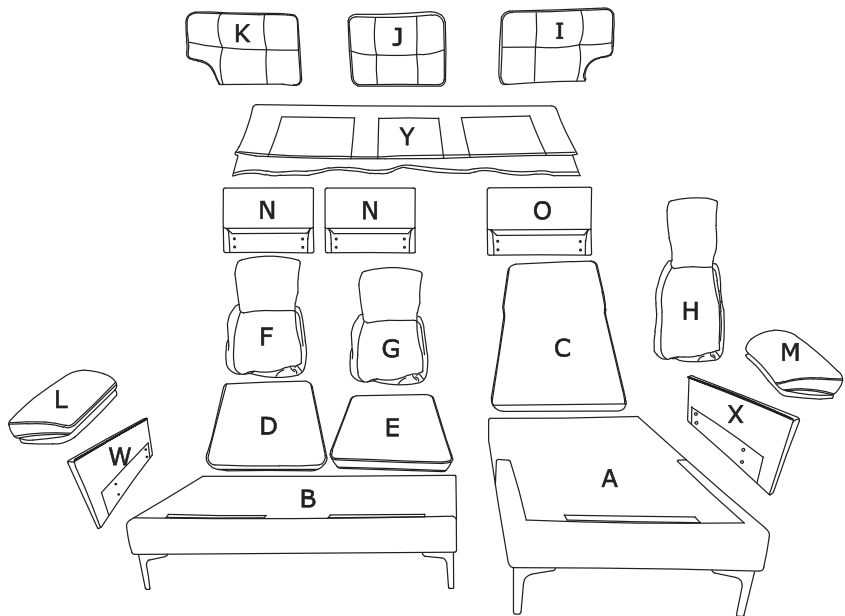





# ASSEMBLY INSTRUCTION

## L SHAPED SECTIONAL





- P  8X Sofa Leg
- Q  16X Bolt 8\*18mm
- R  12X Bolt 8\*65mm
- S  10X Bolt 8\*80mm
- T  12X Butterfly Nut
- U  24X Flat Washer
- V  1X Allen Key M5

TOOLS REQUIRED:  SCISSORS (NOT INCLUDED)

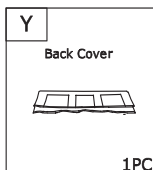
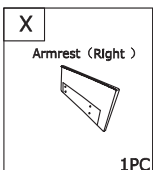
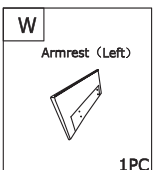
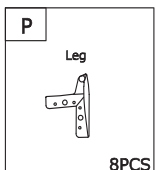
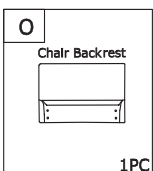
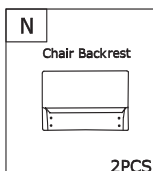
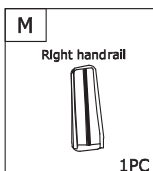
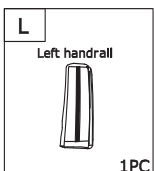
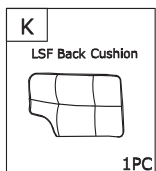
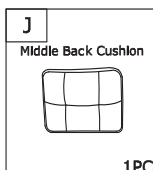
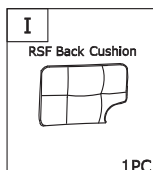
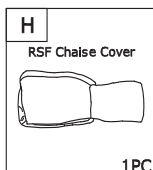
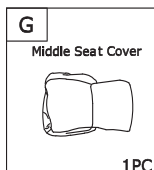
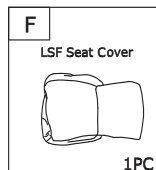
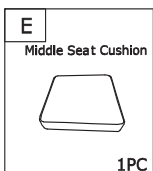
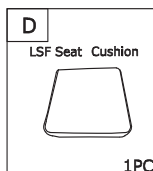
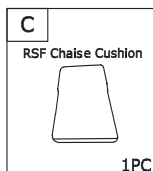
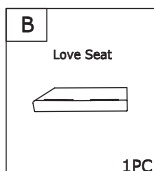
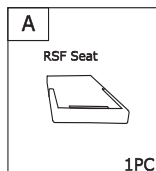

STEP 1

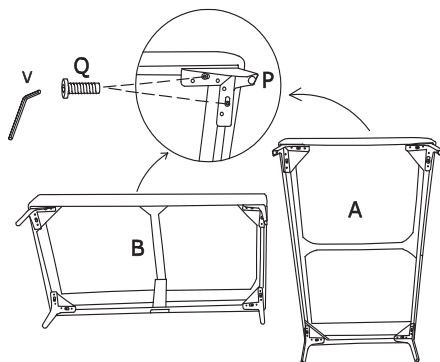

Assemble iron leg (P) with bolts (Q).

Q		16PC
P		8PC



STEP 2

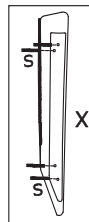
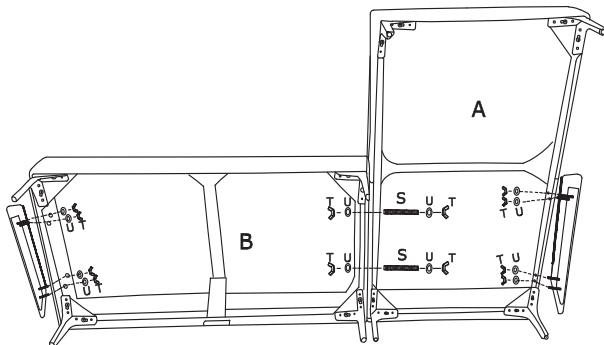
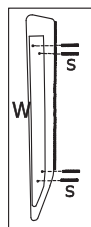

Assembly handrail (w) (x) with bolts (S) flat Washer (U) butterfly nut (T) assembly, Then assemble the seat frame with screw (S) washers (U) butterfly nuts (T).

S		10PC
T		12PC
U		12PC



STEP 3

Fixed back frame (N) and (O) with bolts (R) and flat gaskets (V).

R		12PC
U		12PC

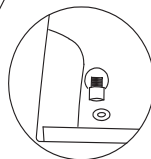
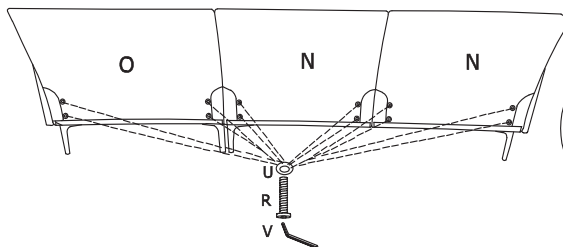

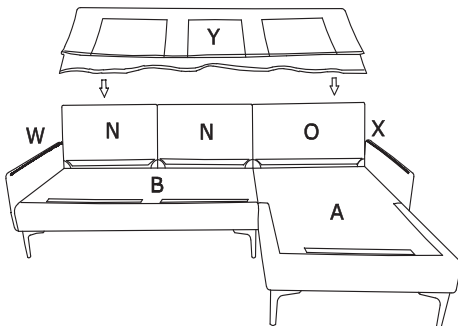
**STEP 4****Put the Back Cover on the back frame.****STEP 5**

The cushion is packaged by vacuum compression .After cutting the package,it rebounds quickly within 10s.If the fabric has wrinkles,it will basically disappear after standing for 72 hours

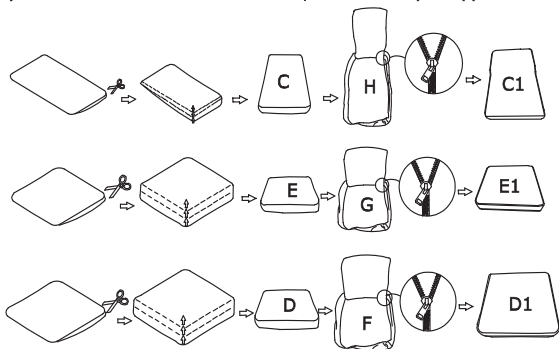

Please align the chain first and then pinch the zipper gently and close it smoothly

**STEP 6**

Put the seat cushion on the sofa first, then pull up the left arm(L) Zipper for right handrail (M).

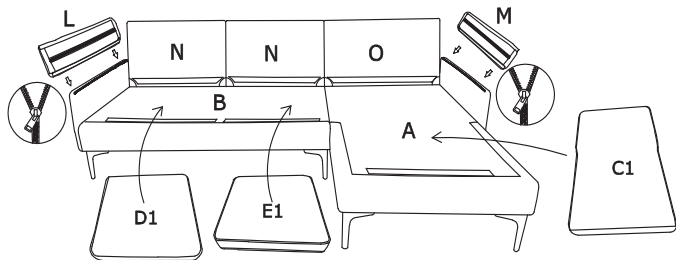

STEP 7

Put the backpack on the sofa.

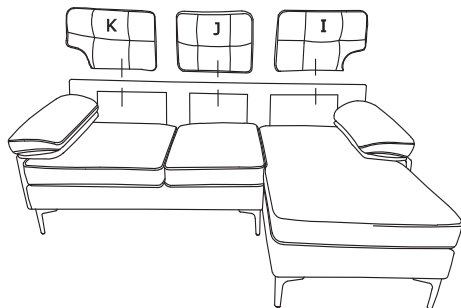

STEP 8

If the fabric has wrinkles, placing 72 hours will basically disappear. Well done! ! You can now enjoy your leisure time on the sofa.

