

# Manual Book

## Ceiling Fan with Lights

Model No.: YY52-2530H/YY52-2530S

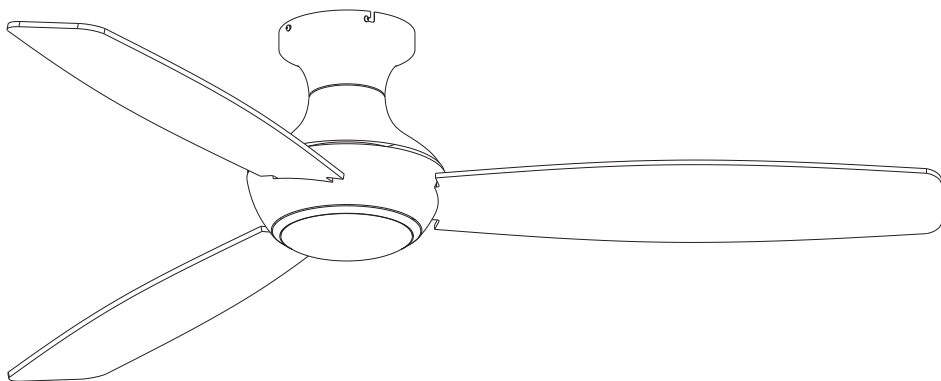

Scan for Installation Video



APP Control Applicable

# Safety Rules

---

1. Be sure the power to the wires you are working on is disconnected, either the fuse is removed or the circuit breaker is turned off. Turning the power off using the light switch is not sufficient to prevent electrical shock.
2. A qualified licensed electrician is required for the installation.
3. The outlet box and support structure must be securely mounted and capable of reliably /supporting a minimum of 70 pounds. Use only UL (cUL for Canadian Installation) listed mounting boxes marked "FOR FAN SUPPORT".
4. The fan must be mounted with a minimum of 7 feet clearance from the trailing edge of the blades to the floor.
5. Do not operate reversing switch while fan blades are in motion (if applicable). The fan must be turned off and the blades stopped before reversing the blade direction.
6. Do not place any objects in the path of the blades.
7. To avoid personal injury or damage to the fan and other items, be cautious when working around or cleaning the fan.
8. Do not use water or detergents when cleaning the fan or fan blades. A dry dust cloth or lightly dampened soft cloth will be suitable for the cleaning.
9. After marking electrical connections, spliced conductors should be turned upward and pushed carefully up into the outlet box. The wires should be spread apart with the grounded conductor on one side of the outlet box.
10. Electrical diagrams are reference only, different fan lights may have different light shades and bulbs.
11. Use only our replacement parts.

This equipment has been tested and found to comply with the limits for a class B digital device, pursuant to part 15 of the FCC Rules.

These limits are to provide reasonable protection against harmful interference in a residential installation.

This equipment generates, uses, and radiate radio frequency energy and if not installed and used in accordance with the instructions may cause harmful interference to radio communications.

## **Warning:**

To reduce the risk of personal injury, use only the two steel screws and washers provided with the outlet box for mounting to the outlet box. Most outlet boxes commonly used for the support of lighting fixtures are not acceptable for fan support and need to be replaced, consult a qualified electrician if in doubt.

To reduce the risk of fire, electric shock, or personal injury, mount the fan to the outlet box marked "acceptable for fan support".

To reduce the risk of personal injury, do not bend the blade brackets (also referred to as flanges) during assembly or after installation. Do not insert objects in the path of the blades.

# Installation Preparation

## Tools Your Need



Ladder

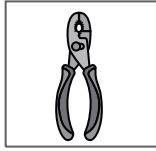

Pliers

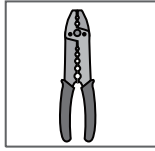

Wire Strippers

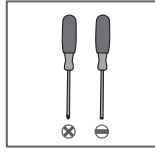

Screwdrivers



Power Drill (optional)



Drill Bit (optional)

If mounting to a support structure, you will also need the optional tools.

## What to Expect with Your Installation

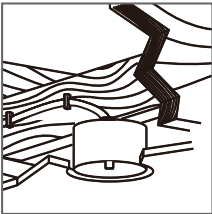

Must be able to secure the fan to building structure or fan-rated outlet box

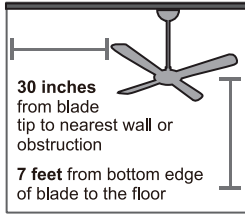

Assess location



Check the box to see the weight of the fan





Not applicable for angled ceiling

# Switch Selection

**Note:** Using a dimmer switch to control the fan may damage the fan. To reduce the risk of fire or electrical shock, do not use a dimmer switch to control the fan.

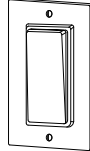
**The recommended switches are as follows:**

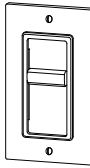
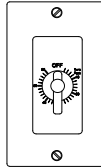
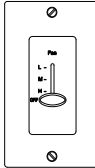
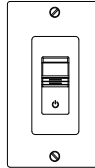
 <b>Recommended:</b>	 Single Pole Switch (Not Included)
 <b>Not Recommended:</b>	 Dimmer Switch  Timer Switch  Fan Speed Control Switch  Motion Sensor Switch

# Installation Recommended

**Room Size:**

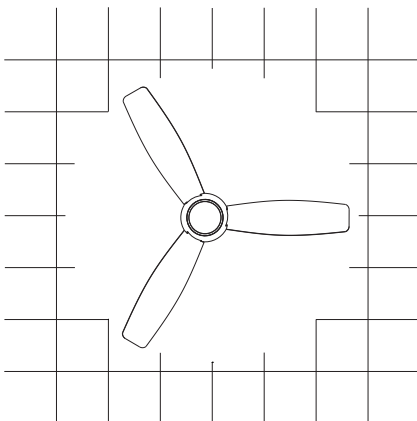





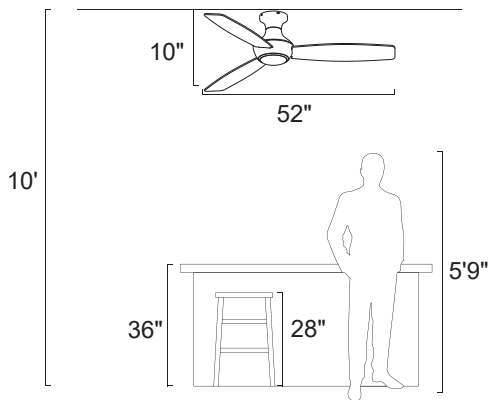

**UP TO 12 ft x 14 ft**

**Room Height:**

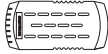









**Recommended ceiling height: 8 to 12 ft.**

# Packing List

- A Mounting Bracket × 1 
- B Receiver × 1 
- C Canopy × 1 
- D Fan Motor Assembly × 1 
- E Fan Blade × 3 
- F LED Light Kit × 1 
- G Light Shade × 1 

# Installation Kit

<b>AA</b>  Wire Nut	<b>BB</b>  Outlet Box Screw	<b>CC</b>  Wood Screw
<b>DD</b>  Expansion Screw	<b>EE</b>  Flat Washer	<b>FF</b>  Balance Kit
<b>GG</b>  Red Washer	<b>HH</b>  Remote Control and Holder	<b>II</b>  Gloves

Note:

1. The listed quantity is for installation, extra hardware may be included.

# Installation Instructions

## 1. Install the Mounting Bracket

Secure the mounting bracket (A) to the outlet box with screws taken off from outlet box or provided screws (BB) and washers (EE). Or mount the mounting bracket to the solid wood structure with wood screws (CC) and washers (EE).

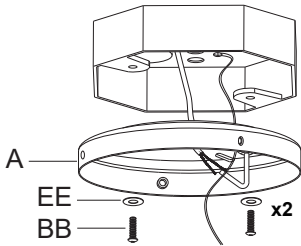

OR

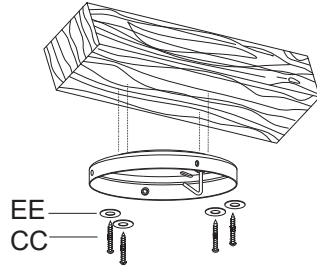

## 2. Assemble the Canopy

**Step 1:** Loosen and remove the set screws from the fan motor assembly (D).

**Step 2:** Secure the canopy (C) to the fan motor assembly (D) with the set screws.

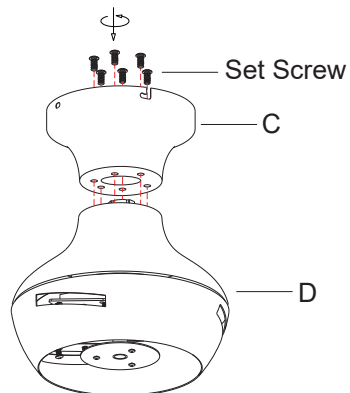
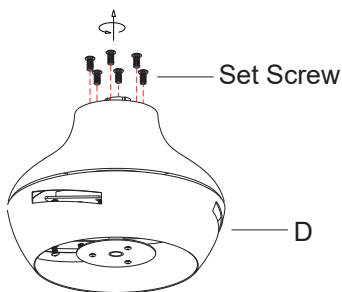

### 3. Connect the Wire

**Step 1:** Hang the fan canopy (C) by hook on mounting bracket (A).

**Step 2:** Insert the receiver (B) into the gap of the Canopy (C).

**Step 3:** Connect the wires on the fan and the receiver (B).

**Step 4:** Connect the wires from the receiver (B) to the house supply wires with wire nuts (AA), ground wire (green, green/yellow, or bare copper) to ground wire, neutral wire (white) to neutral wire, and hot wire (black) to hot wire. Wrap the connection with electrical tape.

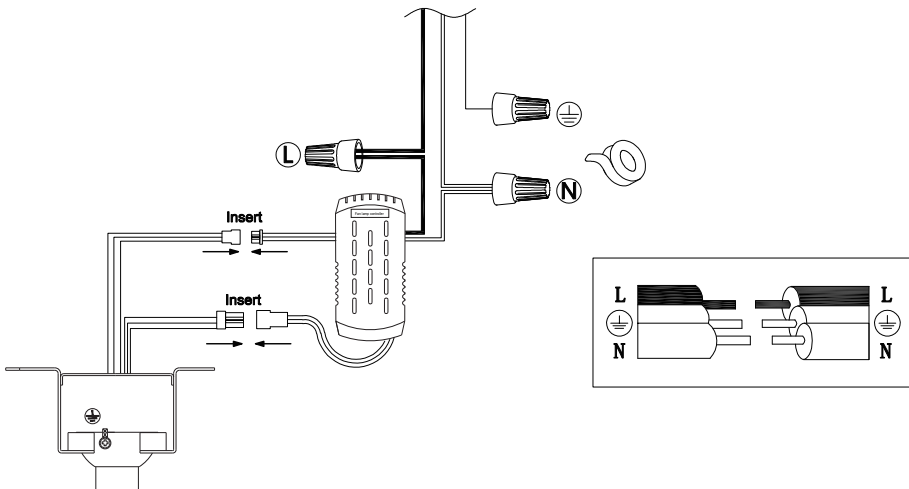
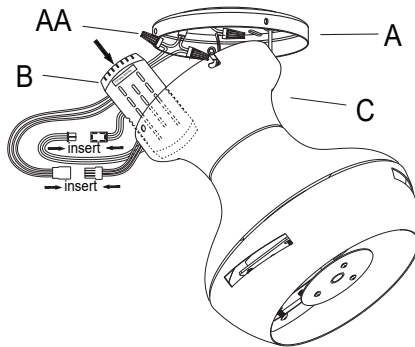

## 4. Fix the Canopy

**Step 1:** Align the “L” slots on the canopy (C) to the canopy screws on the mounting bracket (A), rotate the canopy (C) to lock it onto the mounting bracket (A).

**Step 2:** Tighten the canopy screws to secure the canopy (C).

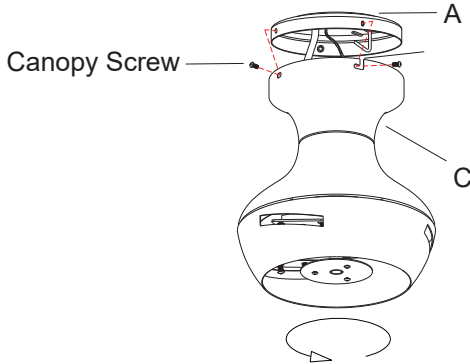

## 5. Assemble the Fan Blade

**Step 1:** Loosen and remove the fan blade screws from the fan motor assembly (D).

**Step 2:** Insert the fan blades (E) into the fan motor assembly (D) and align the round holes of the fan blades (E) with those on the fan motor assembly (D). Secure them with red washers (GG) and fan blade screws.

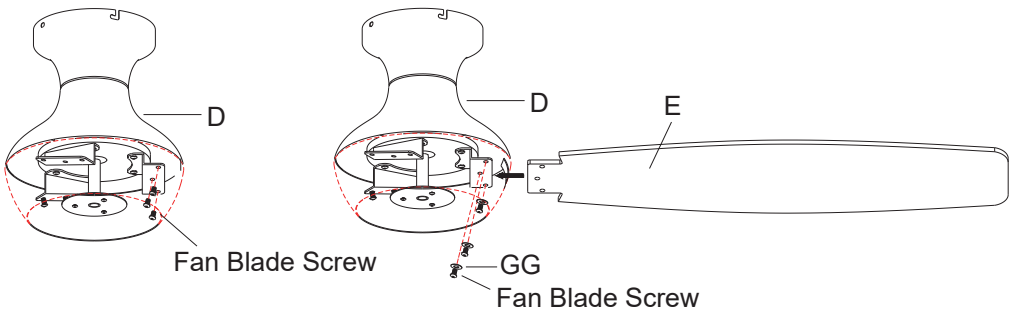

## 6. Install the Light Source and Light Shade

**Step 1:** Take off the set screws from fan motor assembly (D).

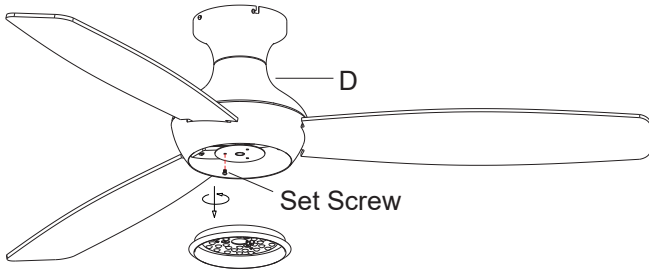

**Step 2:** Secure the LED light kit (F) onto the fan motor assembly (D) with set screws taken off.

**Step 3:** Connect the wire terminal to the interface on the LED light kit (F).

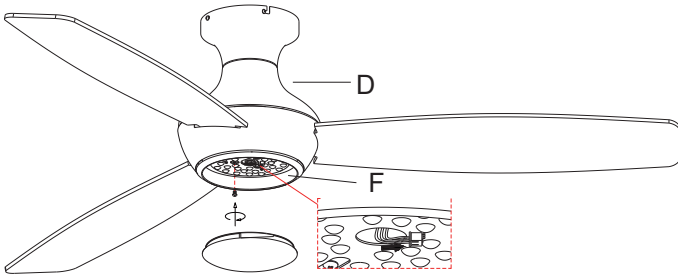

**Step 4:** Rotate the light shade (G) to secure it to the LED light kit (F).

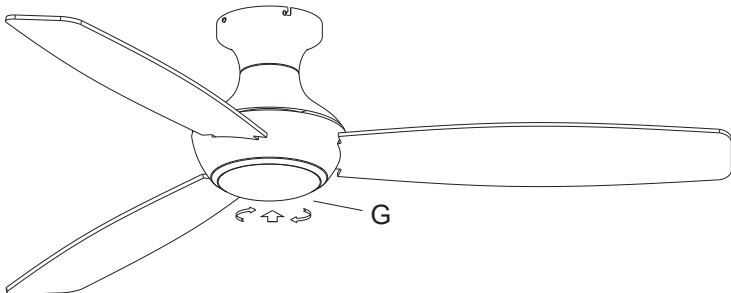

# Remote Control Instructions

		Turn off fan and light.
		Turn on/off the light.
		Quick switch of the light color: Yellow Light → White Light → Natural Light
		Adjust the brightness of the light.
		Adjust the light color temperature.
		Night mode, lights will be dimmed.
		Fan speeds 1 through 6.
		Switch the fan's rotation direction between forward and reverse.
		Natural Wind Mode: Fan speed automatically adjusts.
		Turn off the fan.
		Set a 2-hour timer for the fan.

**NOTE:**

Please insert 2 batteries before using: AAA 1.5V battery x 2pcs (not included).

**REMOTE SIGNAL PAIRING:**

If the remote control loses signal with the fan, turn off the power from wall switch, then turn it on, immediately press and hold button for around 3 seconds, after the fixture beeps or flashes, it's done.

# APP Control Instructions

Install the "FanLamp Pro" app from Google Play, Apple App Store, or other app stores by scanning the QR code or searching for the app name. Ensure that your phone is connected to the internet and Bluetooth enabled.

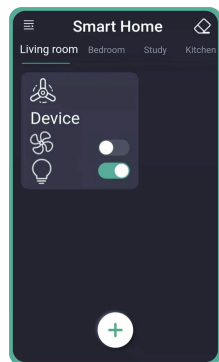
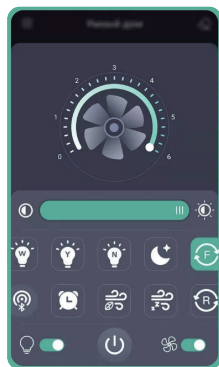

	Pairing: Click the Pair button within 5 seconds after turning on the fan from the wall switch. Once the fan flashes or beeps, it has been successfully paired with your phone and can now be controlled through the app.
	Turn on/off the light.
	Quick switch for "White" light color.
	Quick switch for "Yellow" light color.
	Quick switch for "Natural" light color.
	Night mode: Dim the lights.
	Slide the slider to change the brightness of the light.
	Slide the slider to change the fan speed.
	Fan moves forward.
	Fan moves reversely.
	Change the direction of the wind. (Not supported)
	Timing the fan.
	Natural wind: The fan speed will change automatically when you use this function
	Sleeping wind. (Not supported)
	Turn on/off the fan.
	Unpairing: Click the unpair button within 5 seconds after turning on the fan. Once the fan flashes or beeps, it has been successfully unpaired from your phone.

# Trouble Shooting

---

## 1. Fan does not work

- Make sure the fixture is connected to an ON/OFF wall switch, not a dimmer switch.
- Check the remote control battery (not included in this package).
- Check the circuit breaker to ensure the power is on.
- Check the power cord connection and the power supply connection.

## 2. Lights do not light up / flicker / noisy operation

- Make sure the fixture is connected to an ON/OFF wall switch, not a dimmer switch.
- Check your power and switch to make sure it's powered on.

## 3. Noisy operation

- Re-tighten all screws on the bracket.
- Check to see if any of the blades are cracked. If so, replace the blades.

## 4. Remote does not work

- Make sure the battery is installed correctly.
- Pair the remote control again. (See "Remote Control Instructions")
- Install two new batteries.

# Clean And Care

---

To clean, wipe the fixture with soft cloth. Spray from chemical cleaners can discolor the finish of the fixture. Do not use scouring pads, powders, steel wool or abrasive paper to clean this fixture.

# Ordering Parts

---

Keep this manual for future reference, and in case replacement parts are needed. Available parts can be ordered from place of purchase. Use exact wording from diagrams when ordering parts.