



User's Manual



INSTALLATION INSTRUCTIONS

Installation Manual

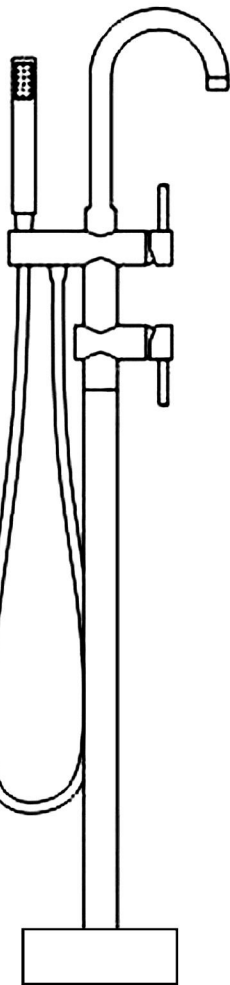

RB1106

IAPMO RESEARCH AND TESTING, INC.
5001 East Philadelphia Street, Ontario, California 91761-2816 • (909) 472-4100 • Fax (909) 472-4244 • www.iapmo.org

CERTIFICATE OF LISTING

IAPMO Research and Testing, Inc. is a product certification body which tests and reports compliance from the supplier's stock or from the market or a combination of both to verify compliance to the requirements of applicable codes and standards. This activity is coupled with periodic surveillance of the supplier's factory and operations as well as the assessment of the supplier's Quality Assurance System. This listing is subject to the conditions set forth in the accompanying rules and shall not be construed as any recommendation, insurance or guarantee by IAPMO Research and Testing, Inc. of the product except as authorized by written product specifications.

UPC 

The most updated information on this Certificate of Listing is available online at pld.iapmo.org

Effective Date: August 2013 Void After: August 2016

Product: Plumbing Fixture Fittings File No. 6137

Issued To: **Haizheng Heart Cartridge Co., Ltd.**
No. 28 Heilman Dony Road,
Shilong Town,
Haizheng City, GUANGDONG
China

Identification: Plumbing supply fittings complying with this Standard shall be marked with the manufacturer's recognized name, trademark, or other mark or, in the case of private labeling, the name, trademark or other mark of the customer for whom the fitting was manufactured. The marking shall be accomplished by use of a permanent mark or by placing a permanent label on the product. Markings on plumbing supply fittings shall be visible after installation.

Single-handle, single-control, and automatic compensating mixing bath and shower valves shall have identifiable temperature control settings in which the settings are indicated by words "cold", "warm", "hot", etc.), by numbers, or graphically.

Packages shall be marked with the manufacturer's name, trademark, or other mark as well as the model number or, in the case of private labeling, the name, trademark, or mark of the customer for whom the fitting was manufactured as well as the model number.

David McHenry
Chairman, Product Certification Committee

Ross Cheney
CEO, The IAPMO Group



This listing period is based upon the last date of the month indicated on the Effective Date and Void After Date shown above. Any change in material, manufacturing process, marking or design without having first obtained the approval of the Product Certification Committee, or any evidence of non-compliance with applicable codes and standards, or the absence of periodic surveillance, shall be deemed sufficient cause for revocation of this listing. Production of or reference to this listing for advertising purposes may be made only by specific written permission of IAPMO Research and Testing, Inc. Any alteration of this certificate shall be grounds for revocation of this listing. This document shall be reproduced in its entirety.

IAPMO RESEARCH AND TESTING, INC.
5001 East Philadelphia Street, Ontario, California 91761-2816 • (909) 472-4100 • Fax (909) 472-4244 • www.iapmo.org

CERTIFICATE OF LISTING

IAPMO Research and Testing, Inc. is a product certification body which tests and reports compliance from the supplier's stock or from the market or a combination of both to verify compliance to the requirements of applicable codes and standards. This activity is coupled with periodic surveillance of the supplier's factory and operations as well as the assessment of the supplier's Quality Assurance System. This listing is subject to the conditions set forth in the accompanying rules and shall not be construed as any recommendation, insurance or guarantee by IAPMO Research and Testing, Inc. of the product except as authorized by written product specifications.

UPC 

The most updated information on this Certificate of Listing is available online at pld.iapmo.org

Effective Date: October 2016 -Rev. 11/28/2016- Void After: October 2017

Product: Flexible Water Connectors File No. 4955

Issued To: **Tubman Jianglin Plumbing Hose & Parts Co., Ltd.**
Fuzhou Industry Zone
Tubman County
Chengyang 317400,
China

Identification: Manufacturer's name or trademark and UPC® certification mark. Special note on label "For use with water in exposed locations only."

Characteristics: Flexible water connectors manufactured in various sizes, lengths and metal and fittings for hot or cold water applications that consist of an inner tube, which may or may not have an outer braided cover. Connectors are to be installed for use in accessible locations only and in accordance with the manufacturer's instruction, and the latest edition of the Uniform Plumbing Code.

Products listed on this certificate have been tested by an IAPMO R&T recognized laboratory. This recognition has been granted based upon the laboratory's compliance to the applicable requirements of ISO/IEC 17025.

Products are in compliance with the following code(s):
Uniform Plumbing Code (UPC®)

David McHenry
Chairman, Product Certification Committee

Ross Cheney
CEO, The IAPMO Group



This listing period is based upon the last date of the month indicated on the Effective Date and Void After Date shown above. Any change in material, manufacturing process, marking or design without having first obtained the approval of the Product Certification Committee, or any evidence of non-compliance with applicable codes and standards, or the absence of periodic surveillance, shall be deemed sufficient cause for revocation of this listing. Production of or reference to this listing for advertising purposes may be made only by specific written permission of IAPMO Research and Testing, Inc. Any alteration of this certificate shall be grounds for revocation of this listing. This document shall be reproduced in its entirety.

IAPMO RESEARCH AND TESTING, INC.
5001 East Philadelphia Street, Ontario, California 91761-2816 • (909) 472-4100 • Fax (909) 472-4244 • www.iapmo.org

CERTIFICATE OF LISTING

IAPMO Research and Testing, Inc. is a product certification body which tests and reports compliance from the supplier's stock or from the market or a combination of both to verify compliance to the requirements of applicable codes and standards. This activity is coupled with periodic surveillance of the supplier's factory and operations as well as the assessment of the supplier's Quality Assurance System. This listing is subject to the conditions set forth in the accompanying rules and shall not be construed as any recommendation, insurance or guarantee by IAPMO Research and Testing, Inc. of the product except as authorized by written product specifications.

UPC 

The most updated information on this Certificate of Listing is available online at pld.iapmo.org

Effective Date: November 2016 -Rev. 3/1/2017- Void After: November 2017

Product: Plumbing Fixture Fittings File No. 4528

Issued To: **Heppert, Inc.**
171 Mattatuck Heights
Hartford, CT 06105

Identification: Each fitting component shall bear permanent legible markings to identify the manufacturer. This marking shall be the trade name, trademark, or other mark known to identify the manufacturer. The product shall also bear all other markings required by the standard. The marking shall be located where it can be readily seen after installation is complete. The product or packaging shall also bear the UPC® certification mark.

Characteristics: Plumbing fixture fitting components to be installed in accordance with the manufacturer's instructions and the requirements of the latest edition of the Uniform Plumbing Code.

Products listed on this certificate have been tested by an IAPMO R&T recognized laboratory. This recognition has been granted based upon the laboratory's compliance to the applicable requirements of ISO/IEC 17025.

Products are in compliance with the following code(s):
Uniform Plumbing Code (UPC®)
National Plumbing Code of Canada

Tom Collings
Chairman, Product Certification Committee

Ross Cheney
CEO, The IAPMO Group



This listing period is based upon the last date of the month indicated on the Effective Date and Void After Date shown above. Any change in material, manufacturing process, marking or design without having first obtained the approval of the Product Certification Committee, or any evidence of non-compliance with applicable codes and standards, or the absence of periodic surveillance, shall be deemed sufficient cause for revocation of this listing. Production of or reference to this listing for advertising purposes may be made only by specific written permission of IAPMO Research and Testing, Inc. Any alteration of this certificate shall be grounds for revocation of this listing. This document shall be reproduced in its entirety.

BEFORE INSTALLATION

This product has been inspected and debugged by the factory to the best condition. Please do not disassemble and assemble it yourself.

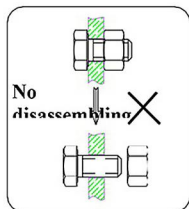

Before installing the faucet, please be sure to remove sundries and sludge from the water pipe to prevent sundries from blocking the faucet.

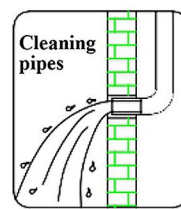

Freestanding Bathtub Faucet Manual

1. Please check everything component by the list below after you open the package, make sure nothing missing, any questions please contact us feel free, we will reply within 24 hours. and solve the issue together with you.

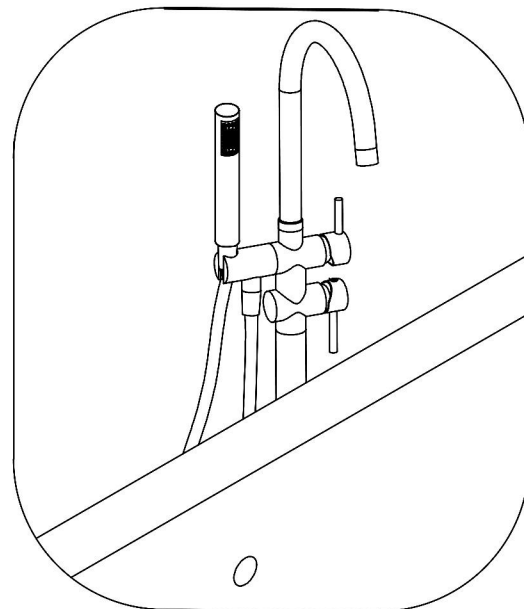

NO.	Part	PCS
1	Main Body	1
2	Straight Tube	1
3	Decorative Cover	1
4	Inlet Tube	2
5	Bolts Holder	1
6	Expansion Bolts	3
7	Shower Head	1
8	Shower Tube	1
9	Manual	1

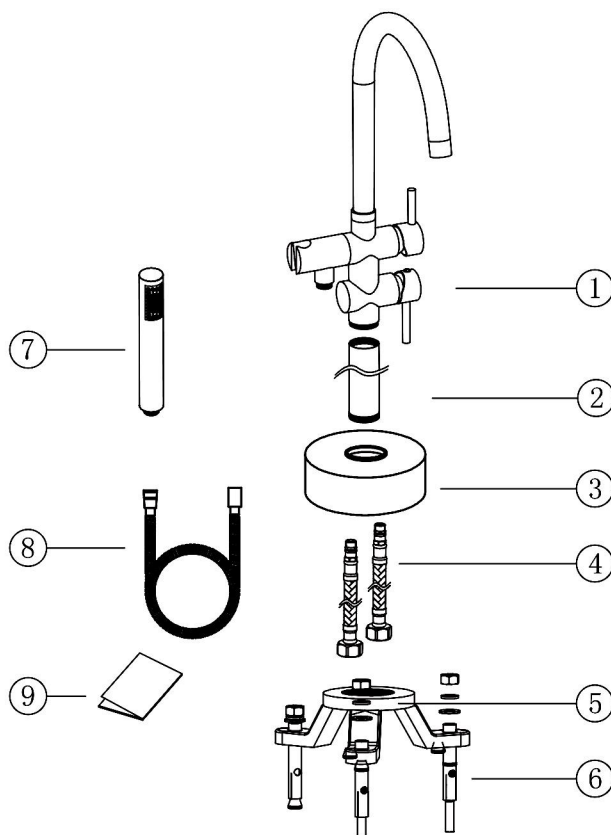

2. Using the faucet for a matching height bathtub.

INSTALLATION STEPS

1. Connect the straight tube, decorative cover and bolts holder to inlet tube then screw the inlet tube to main body.

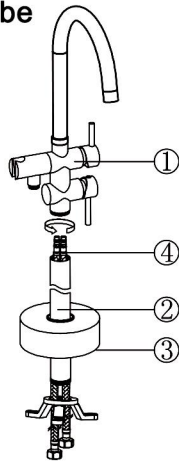

2. Connect the main body with straight tube by twisting it.

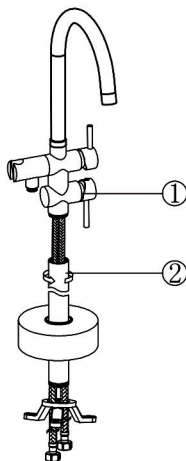

3. Prepare water inlet like the drawing below.

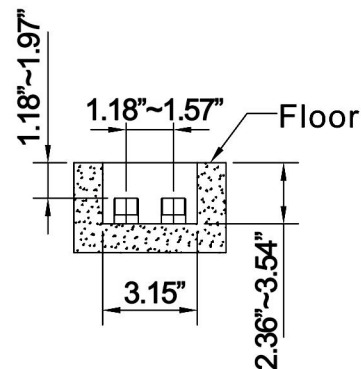

4. Connect the inlet tube like the drawing.

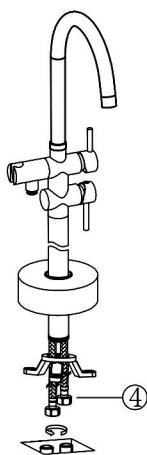

5. Twist the bolts holder to the faucet.

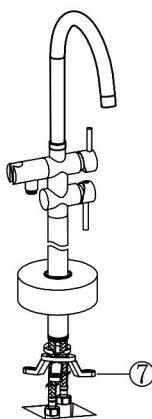

6. Drill holes on floor based on the drawing.

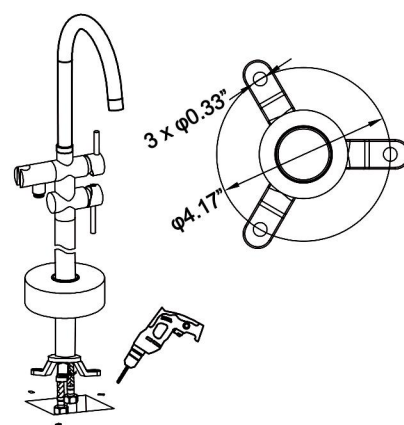

7. Tighten the expansion bolts.

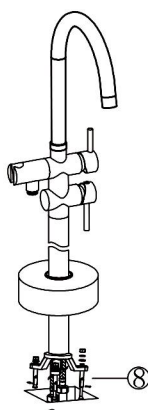

8. Twist the shower tube to both faucet and shower head.

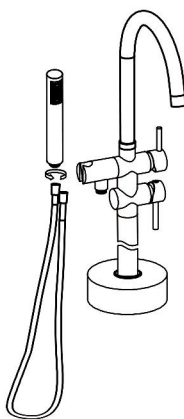

9. Finished assembly.

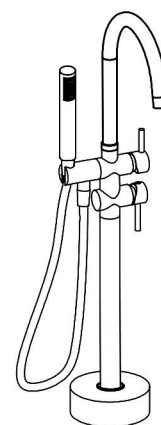

CLEANING CARE

In order to keep the appearance of faucet clean, bright and good performance, please take care of the faucet as follows;

1. Rinse with water only and dry with soft cotton cloth;
2. Use mild liquid and colorless glass cleaner to remove surface dirt and scale film, or use polish without abrasive effect;
3. Do not use abrasive detergent, polish, emery cloth, paper towel or scraper, etc.;
4. Do not use acid cleaner, or cleaner and soap with insoluble gran etc.;
5. In the process of use, mud may accumulate in the bubbler and make the water flow show, The bubbler can be unscrewed, rinsed with water, and then installed back in place.



Please feel free to contact us if you have any questions. We will help to solve the issue together with you. OUR EMAIL: services@rbrohant.com



Service Contact:
+1(801) 800-9309
services@rbrohant.com

Made in China