

ASSEMBLY INSTRUCTIONS

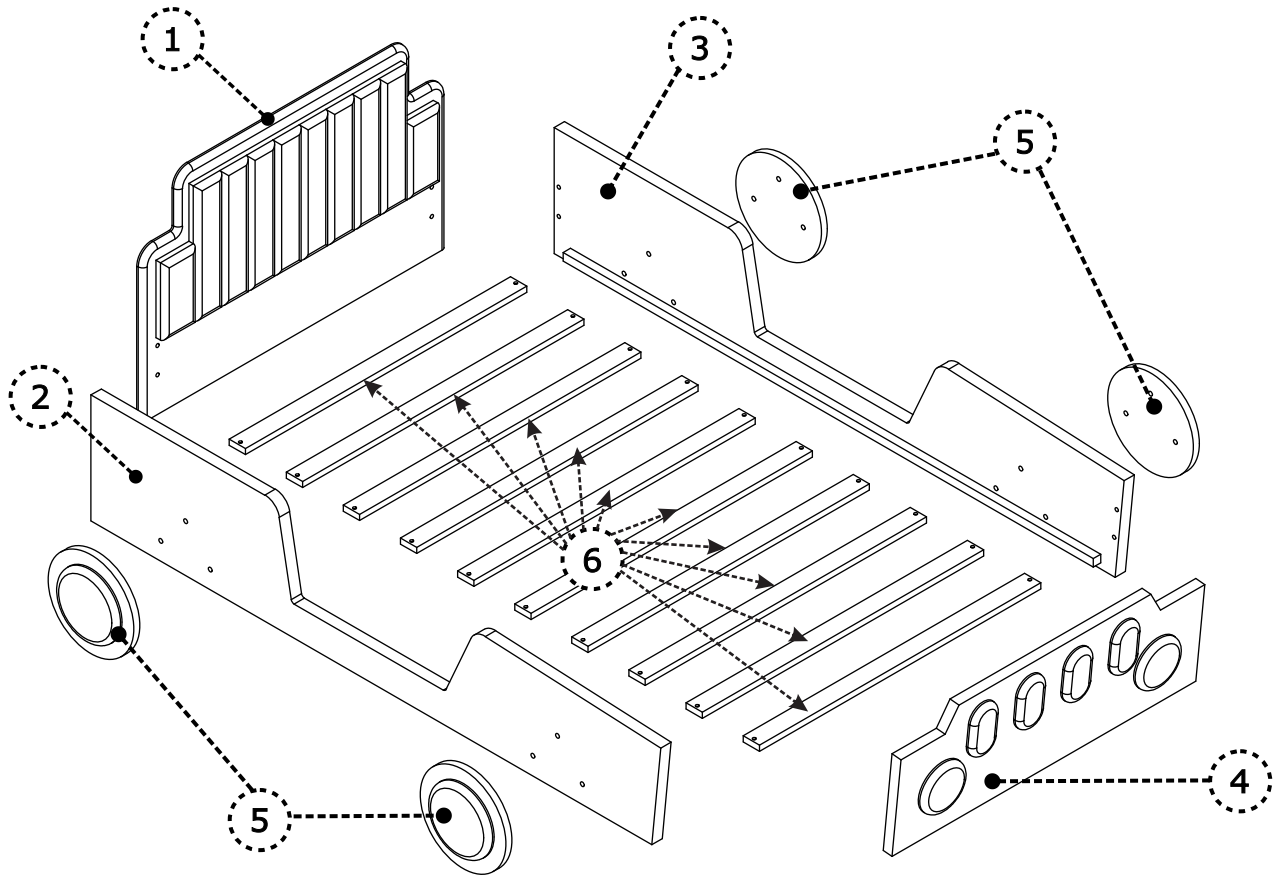

PARTS

Check that you've received
all parts listed below.

BOX: 1/2

2 x 1



Side board Left

3 x 1

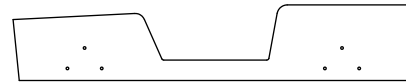

Side board Right

Hardware



PARTS

Check that you've received
all parts listed below.

BOX: 2/2

1 x 1

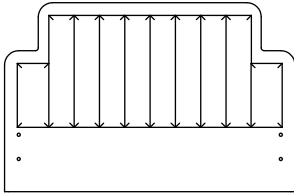

Head Board

4 x 1

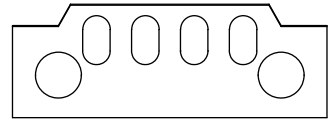

Foot Board

5 x 4

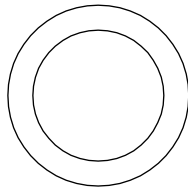

Legs

6 x 10

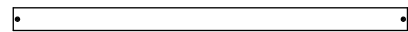







Slats

HARDWARE

Check that you've received all hardware listed below.

Hardware List

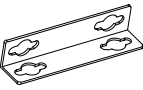
No.	OUTLOOK	DESC	QTY
(A)		Bolts 5/16"x20 mm	16
(B)		Bolts 5/16"x30 mm	12
(C)		Plain washer Ø19x1.5 mm	28
(D)		Spring washer Ø13x1 mm	28
(E)		Allen key 80x30x4 mm	1
(F)		Screws Ø4x30 mm	20
(G)		Steel Pat	4

STEP 1

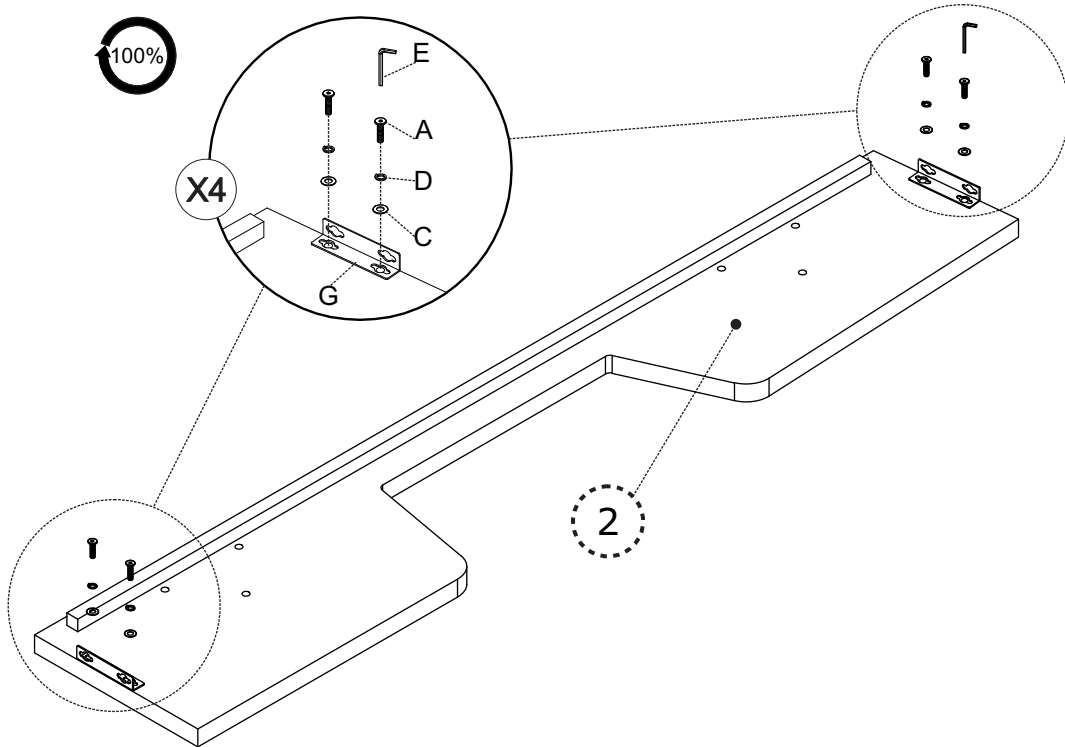
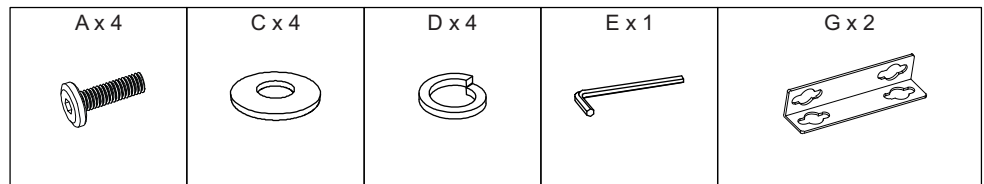

STEP 2

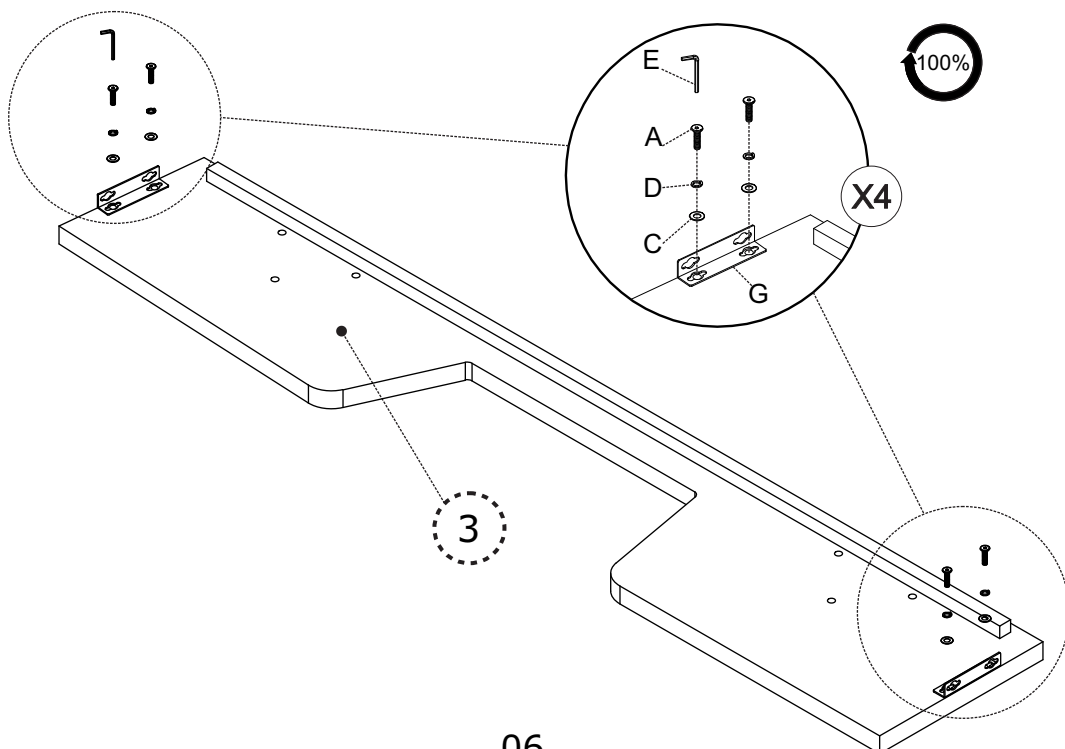
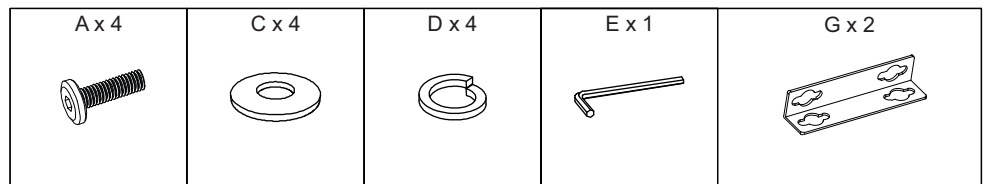

STEP 3

B x 6	C x 6	D x 6	E x 1	
-------	-------	-------	-------	--

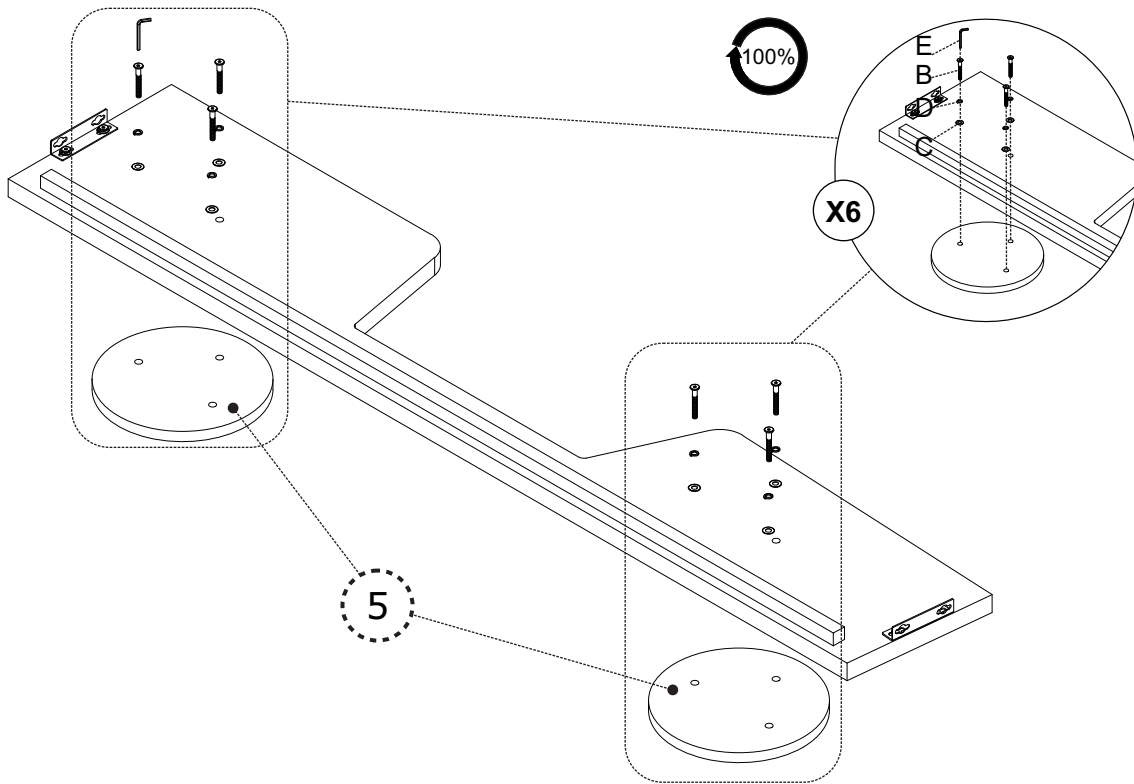



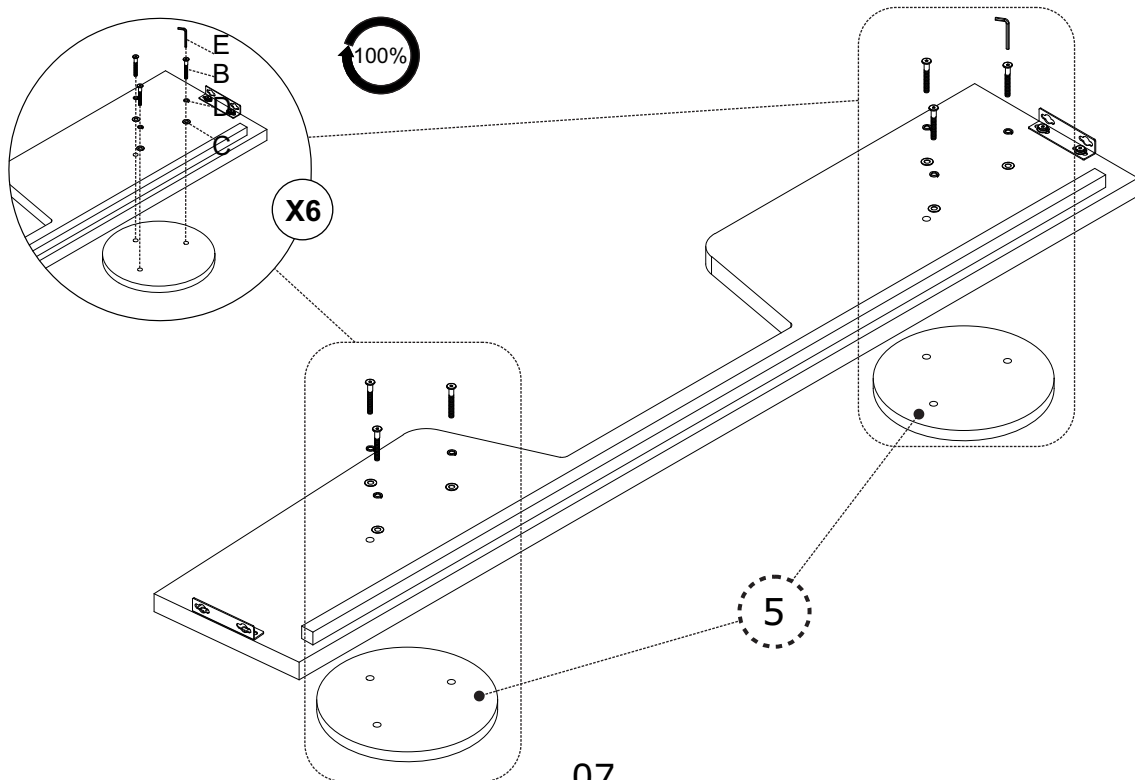

STEP 4

B x 6	C x 6	D x 6	E x 1	
-------	-------	-------	-------	--





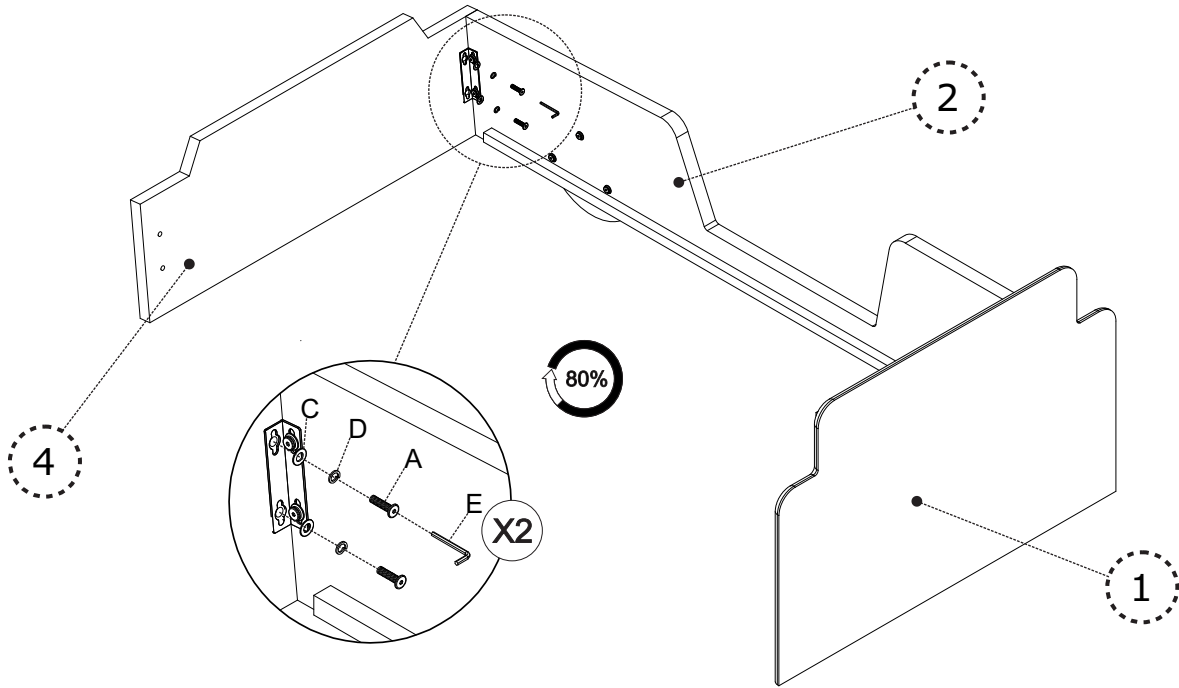

STEP 5

A x 2 	C x 2 	D x 2 	E x 1 	
--------------------------------------------------------------------------------------------	--------------------------------------------------------------------------------------------	--------------------------------------------------------------------------------------------	----------------------------------------------------------------------------------------------	--





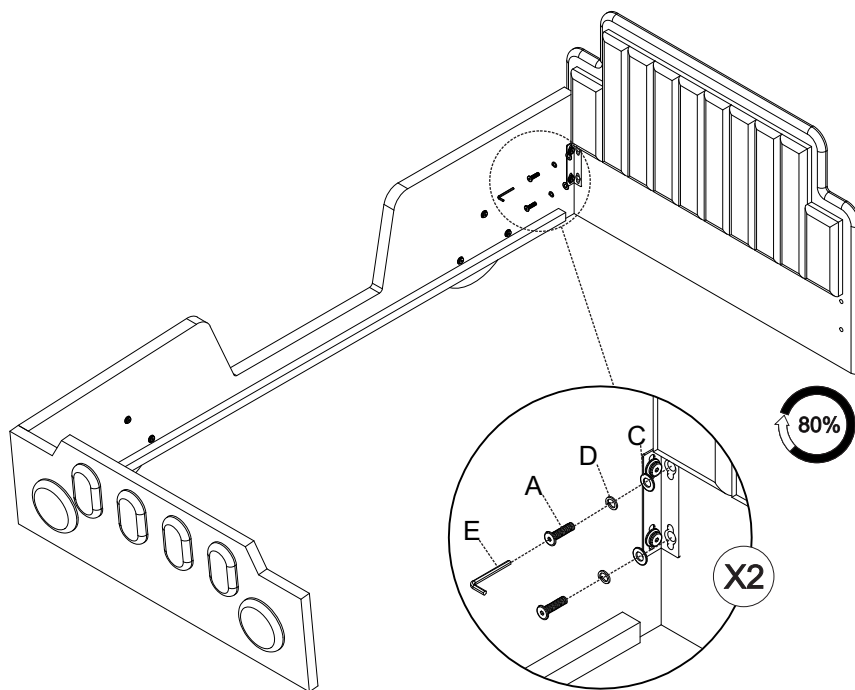

STEP 6

A x 2 	C x 2 	D x 2 	E x 1 	
----------------------------------------------------------------------------------------------	----------------------------------------------------------------------------------------------	----------------------------------------------------------------------------------------------	------------------------------------------------------------------------------------------------	--





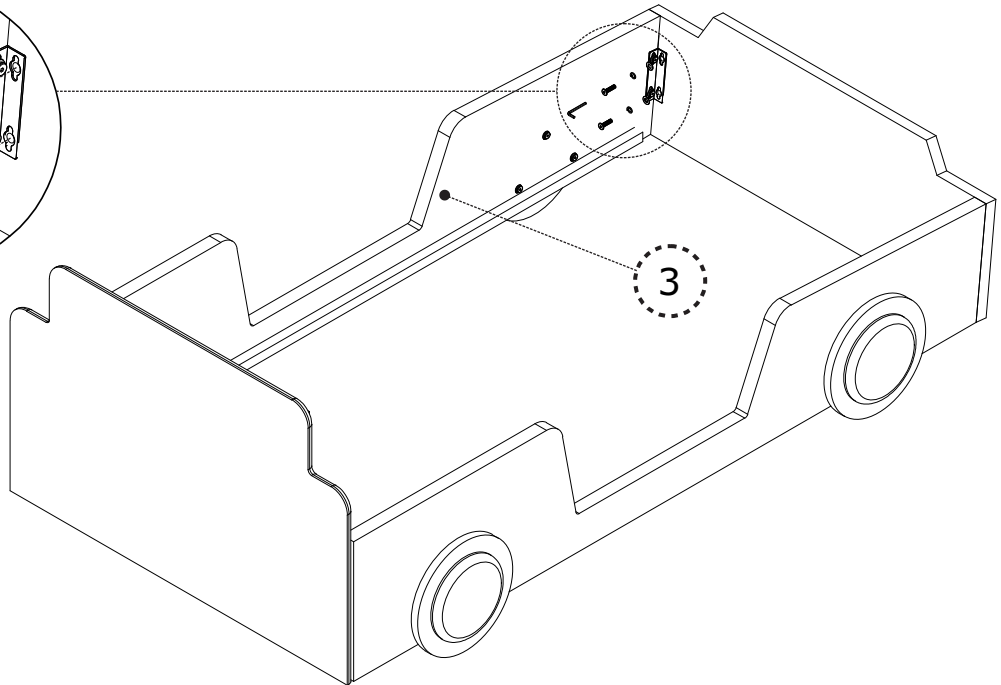
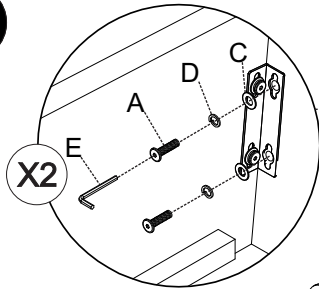

STEP 7

A x 2 	C x 2 	D x 2 	E x 1 	
--------------------------------------------------------------------------------------------	--------------------------------------------------------------------------------------------	--------------------------------------------------------------------------------------------	----------------------------------------------------------------------------------------------	--

80%



STEP 8

A x 2 	C x 2 	D x 2 	E x 1 	
----------------------------------------------------------------------------------------------	----------------------------------------------------------------------------------------------	----------------------------------------------------------------------------------------------	------------------------------------------------------------------------------------------------	--

80%

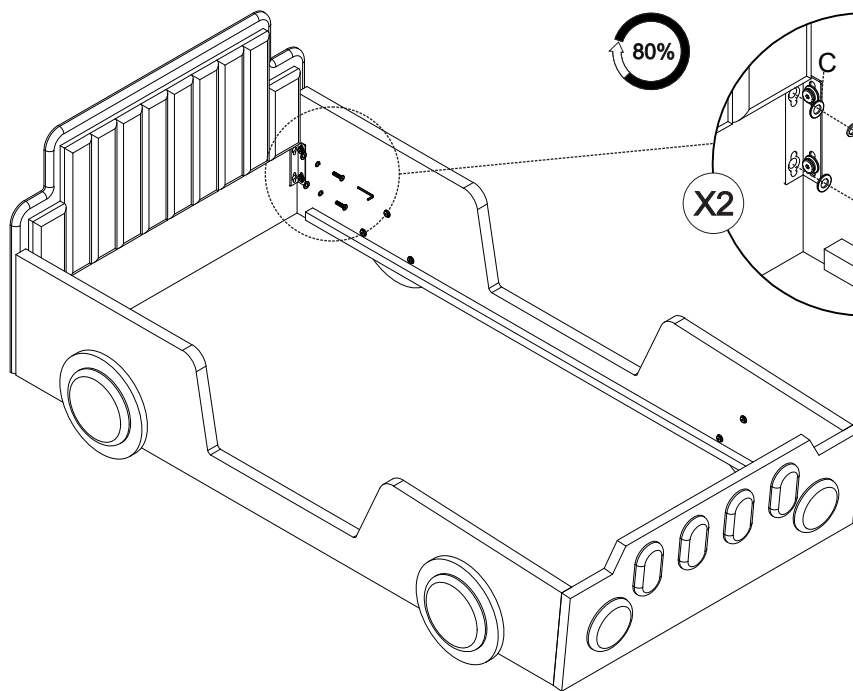
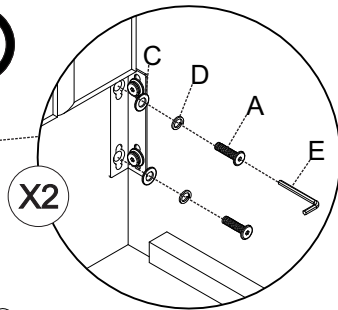

STEP 9

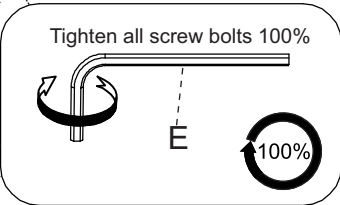
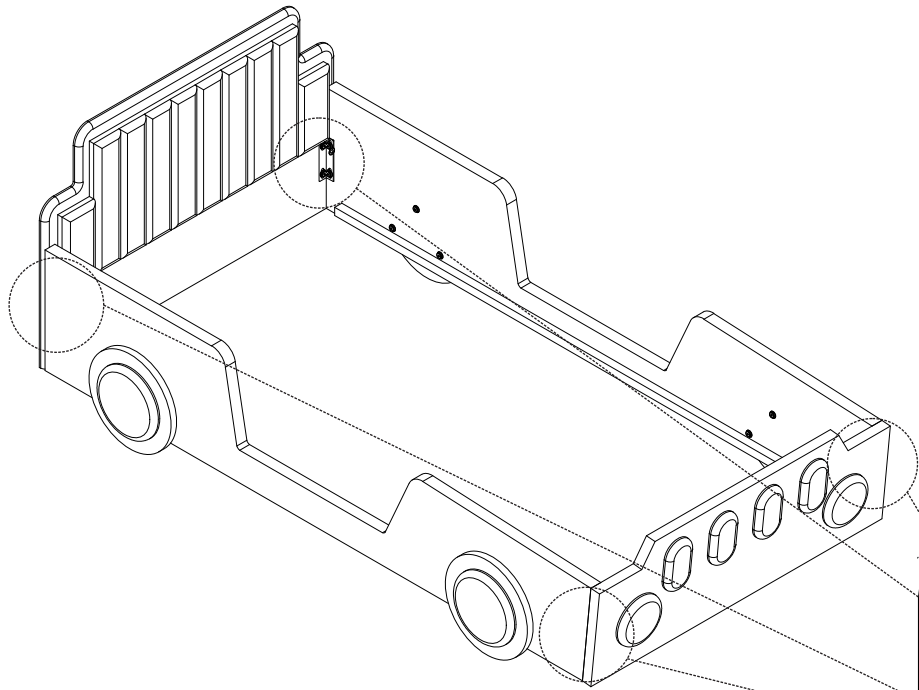
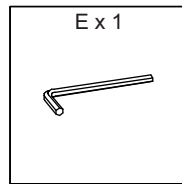

STEP 10

