

ASSEMBLY INSTRUCTION

PLEASE READ BEFORE ASSEMBLING!

Tip #1: Make sure you've taken all the pieces and hardware out of its packaging before discarding the box.

Tip #2: Using page 2 and/or page 3 of instruction manual make sure all pieces and hardware are accounted for.

Tip #3: Read manual before assembling, it helps!

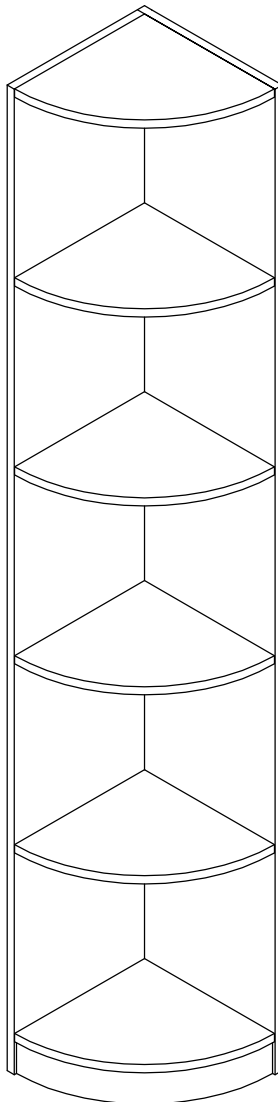

ASSEMBLY INSTRUCTION

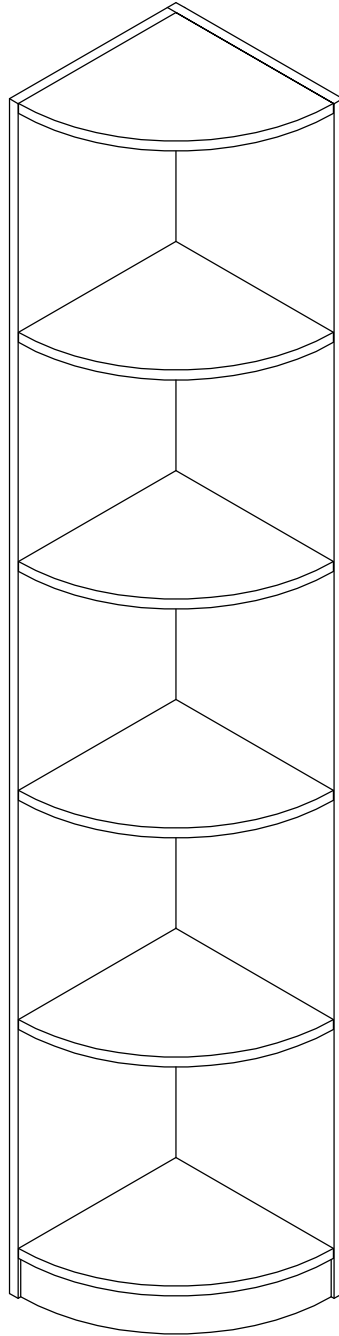



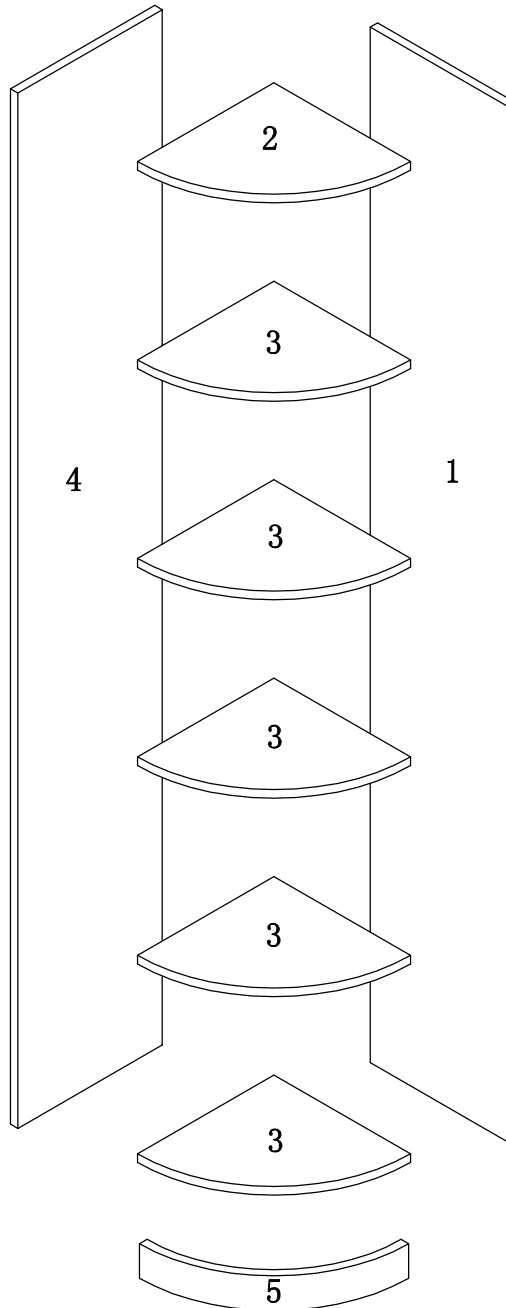



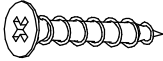

PARTS IDENTIFICATION

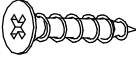
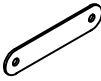

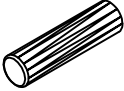
(1)	1pc	(4)	1pc
(2)	1pc	(5)	1pc
(3)	5pcs		

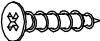
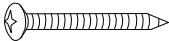
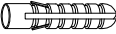
HARDWARE IDENTIFICATION

A		$\phi 4 \times 35$	29pcs
B		$28 \times 20 \times 20$	3pcs
C		$\phi 4 \times 16$	12pcs
D			2pcs
E		$\phi 3 \times 14$	4pcs
F		$\phi 8 \times 25$	12pcs
G		$\phi 16$	4pcs
H		Glue: For securing please apply to wood dowel first before inserting into panel	1pc
I		$\phi 4 \times 25$	1pc
J		$\phi 5 \times 40$	1pc
K			1pc
L			1pc
M			2pc

ASSEMBLY INSTRUCTION

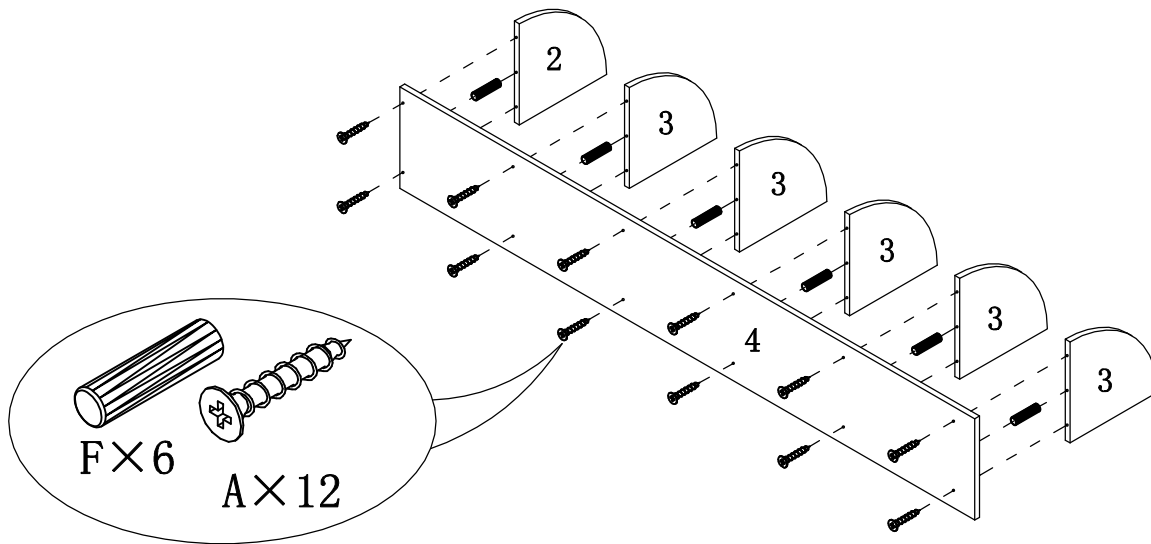

STEP1

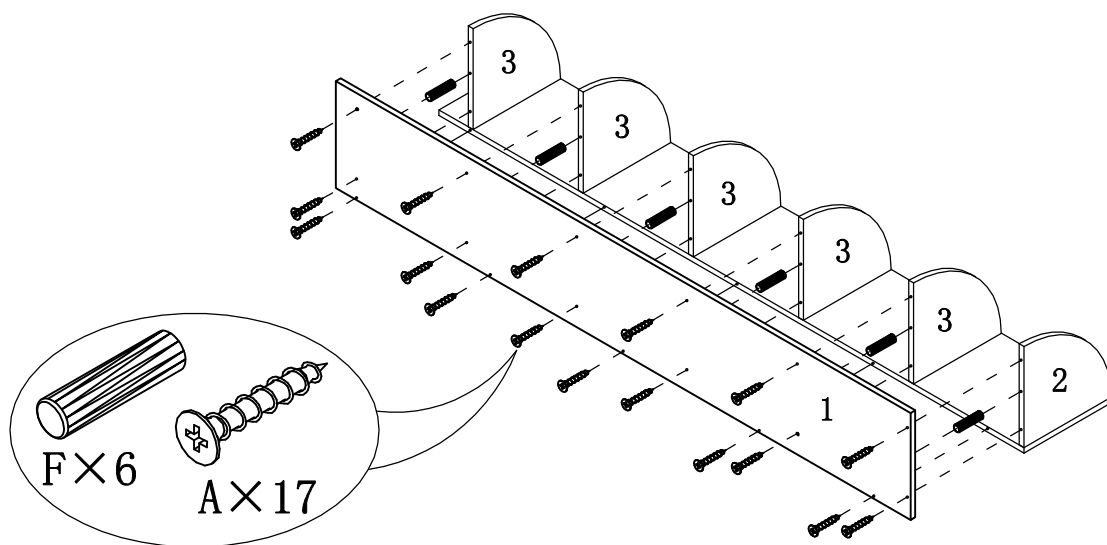

STEP2

PAGE:4 OF 5

ASSEMBLY INSTRUCTION

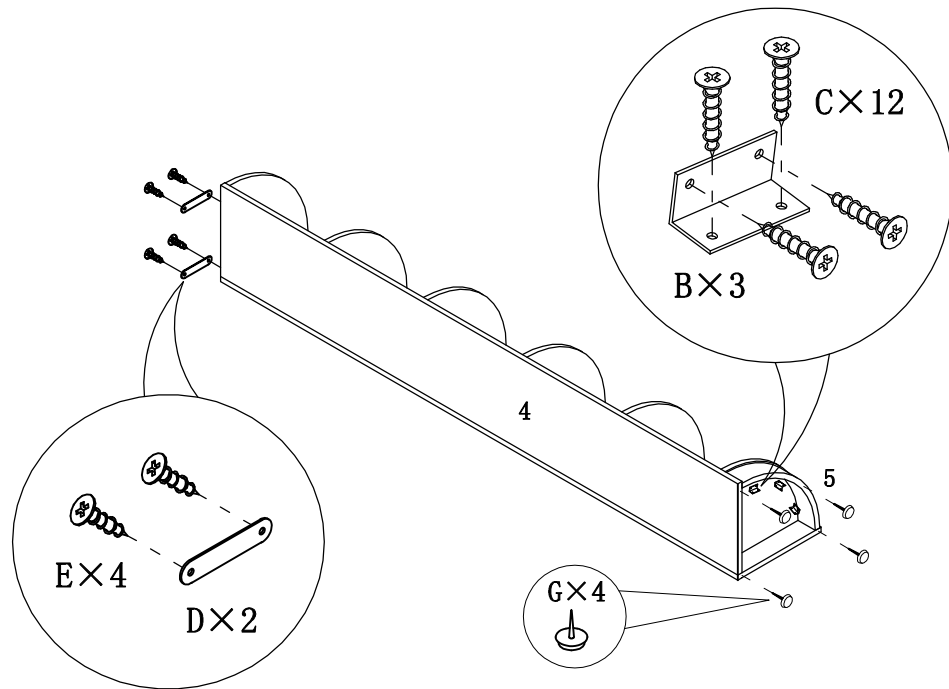

STEP3

STEP4

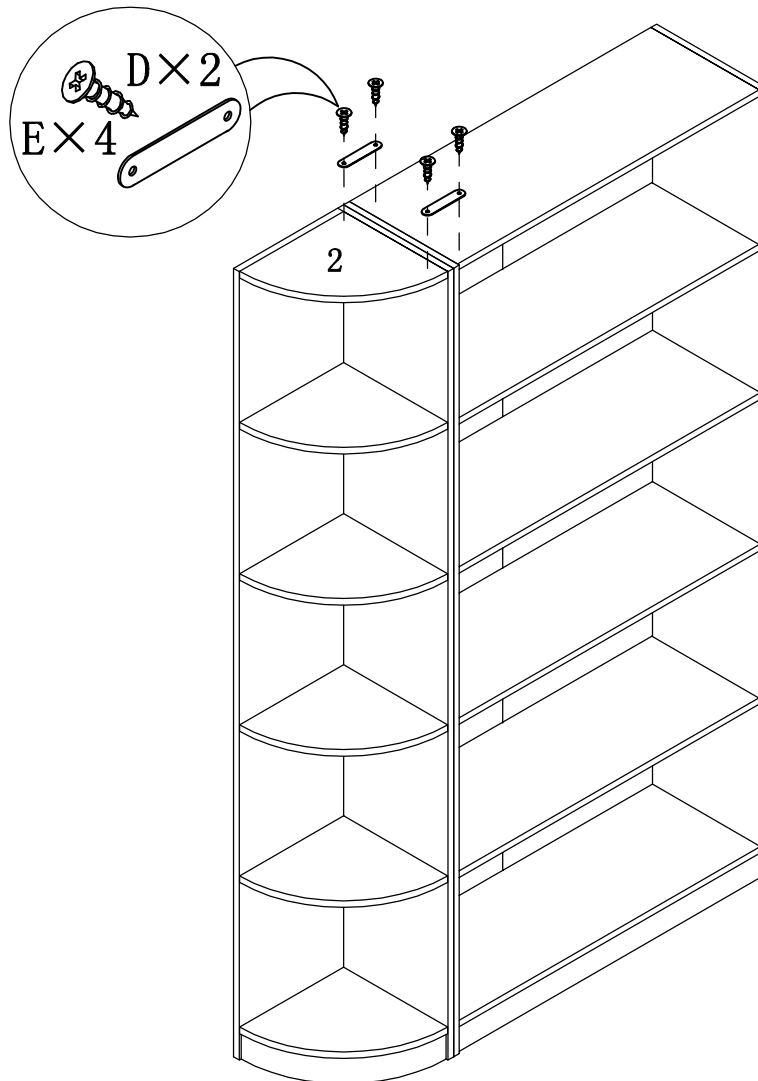

ANTI-TIPPING STRAP INSTRUCTION

HARDWARE (INCLUDED) :

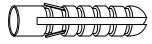

DRYWALL ANCHOR $\phi 8 \times 40$ X 1PC

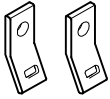

METAL BRACKETS $12 \times 12 \times 1$ X 2PCS

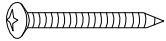

DRYWALL SCREW $\phi 5 \times 40$ X 1PC



STRAP $197 \times 5 \times 1$ X 1PC



FLATHEAD SCREW $\phi 4 \times 25$ X 1PC

TOOLS NEEDED (NOT INCLUDED) :

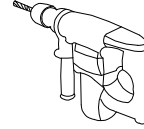

DRILL & DRILL BIT



LIGHT HAMMER

Note: Hardware included only compatible with standard drywalls.

STEP 1

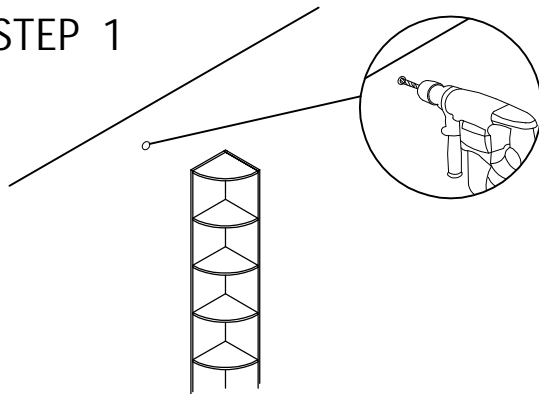

1. Find spot on wall 1" below top of item.
2. Using a drill bit slightly thinner than anchor, drill hole into drywall.

STEP 2

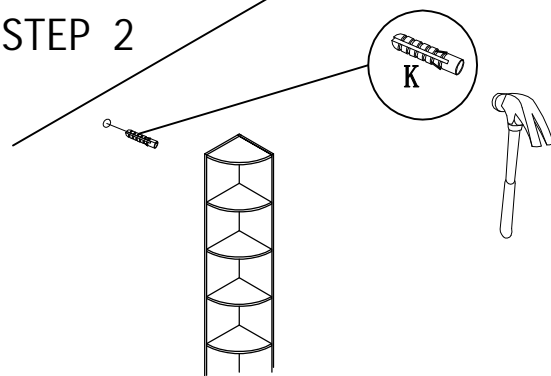

1. Use a light hammer to tap anchor into hole.
2. Anchor should fit snugly. If hole is too small, drill again to increase hole size. Do not force anchor into wall.

STEP 3

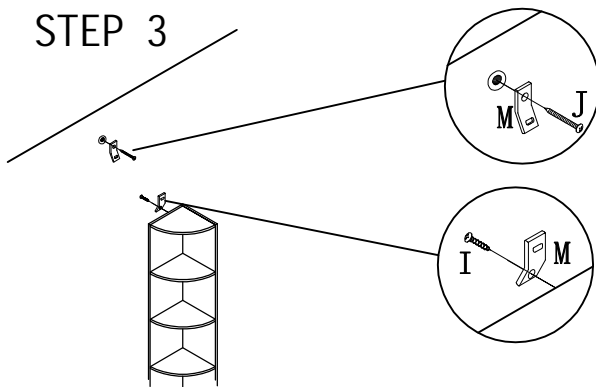

1. Insert drywall screw into metal bracket and into drywall anchor.
2. Insert flathead screw into second metal bracket and into back of item, along top edge.

STEP 4

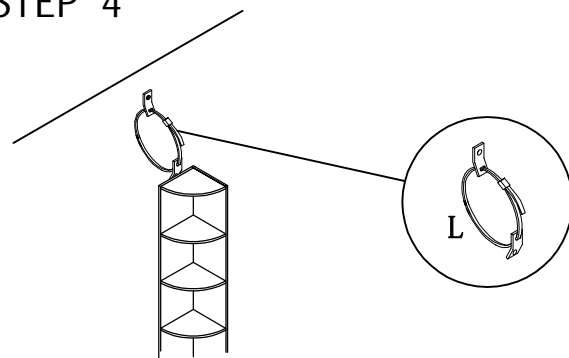

1. Insert strap thru bracket attached to wall, then thru bracket on item, and into head of strap.
 2. pull lightly til strap stops.
- Assembly is complete.