

SMALL ANIMAL CAGES
KLEINTIERKÄFIGE
CAGES POUR PETITS ANIMAUX
GABBIE PER PICCOLI ANIMALI
JAULAS PARA ANIMALES PEQUEÑOS

- !**
1. Confirm all parts are present prior to assembly.
 2. Assemble on a flat, clean and soft surface.
 3. Do not fully tighten screws until all parts are assembled.







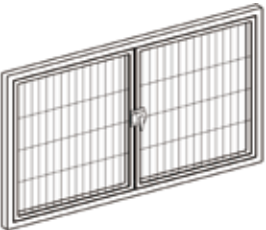
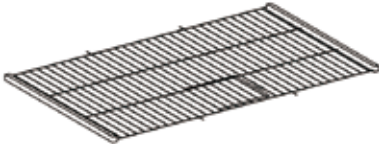
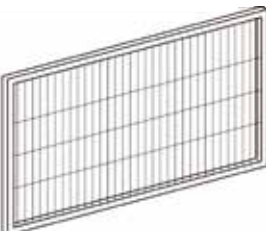
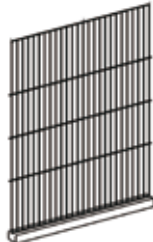

1. Vergewissern Sie sich vor der Montage, dass alle Teile vorhanden sind.
2. Führen Sie die Montage auf einer ebenen, sauberen und weichen Oberfläche durch.
3. Ziehen Sie die Schrauben erst dann vollständig an, wenn alle Teile montiert sind.

1. Confirmez que toutes les accessoires sont présents avant l'assemblage.
2. Assemblez sur une surface plane, propre et douce.
3. Ne serrez pas complètement les vis tant que toutes les accessoires ne sont pas assemblées.

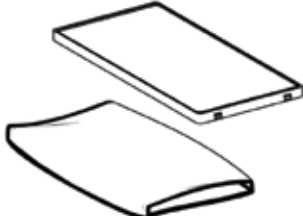
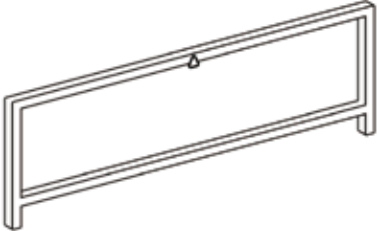
1. Verificare che tutte le parti siano presenti prima dell'assemblaggio.
2. Assemblare su una superficie piana, pulita e morbida.
3. Non serrare completamente le viti finché tutte le parti non sono state assemblate.

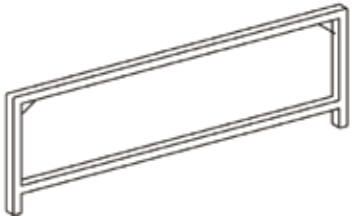
1. Asegúrese de que todas las piezas están en su lugar antes del montaje.
2. Montaje en una superficie plana, limpia y suave.
3. No apriete completamente los tornillos hasta que todas las piezas estén montadas.

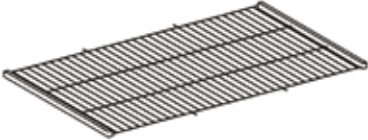
Item no. Nr. N° d'article Articolo No. Artículo No.	Reference Image Referenzbild Image de référence Immagine di riferimento Imagen de referencia	Qty. Menge Qté. Qtà Cant.	Item no. Nr. N° d'article Articolo No. Artículo No.	Reference Image Referenzbild Image de référence Immagine di riferimento Imagen de referencia	Qty. Menge Qté. Qtà Cant.
A		X1	C		X1
B		X1	D		X2

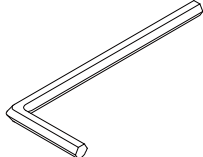
Item no. Nr. N° d'article Articolo No. Artículo No.	Reference Image Referenzbild Image de référence Immagine di riferimento Imagen de referencia	Qty. Menge Qté. Qtà Cant.	Item no. Nr. N° d'article Articolo No. Artículo No.	Reference Image Referenzbild Image de référence Immagine di riferimento Imagen de referencia	Qty. Menge Qté. Qtà Cant.
E		X1	K		X1
F		X1	L		X1
G		X1	M		X4
H		X1	N	 M6X30mm	X16
I		X1	O	 M5X25mm	X4
J		X2	P		X1

1

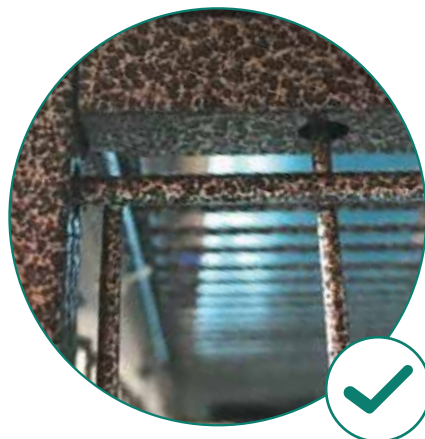
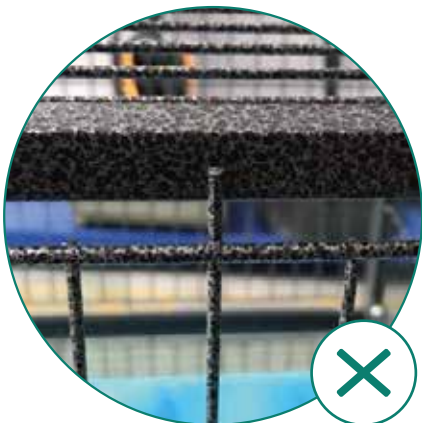
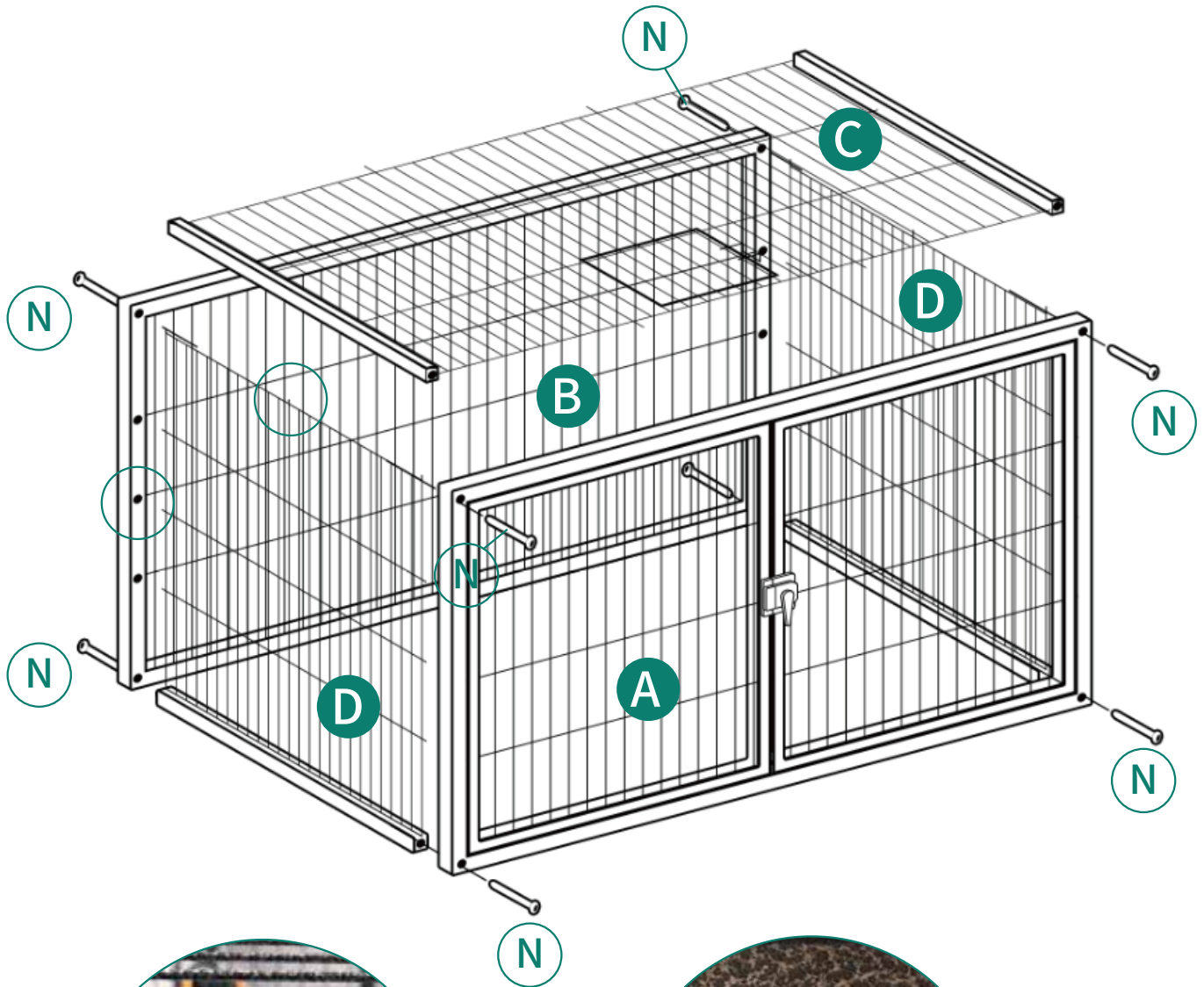
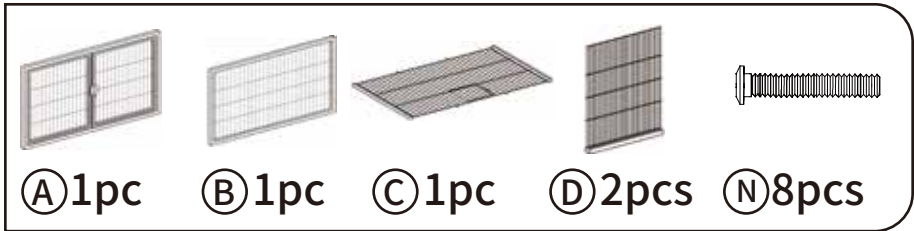

2



ⓐ 1pc



ⓓ 1pc



ⓔ 1pc



ⓙ 2pcs



Ⓜ 4pcs



Ⓝ 8pcs

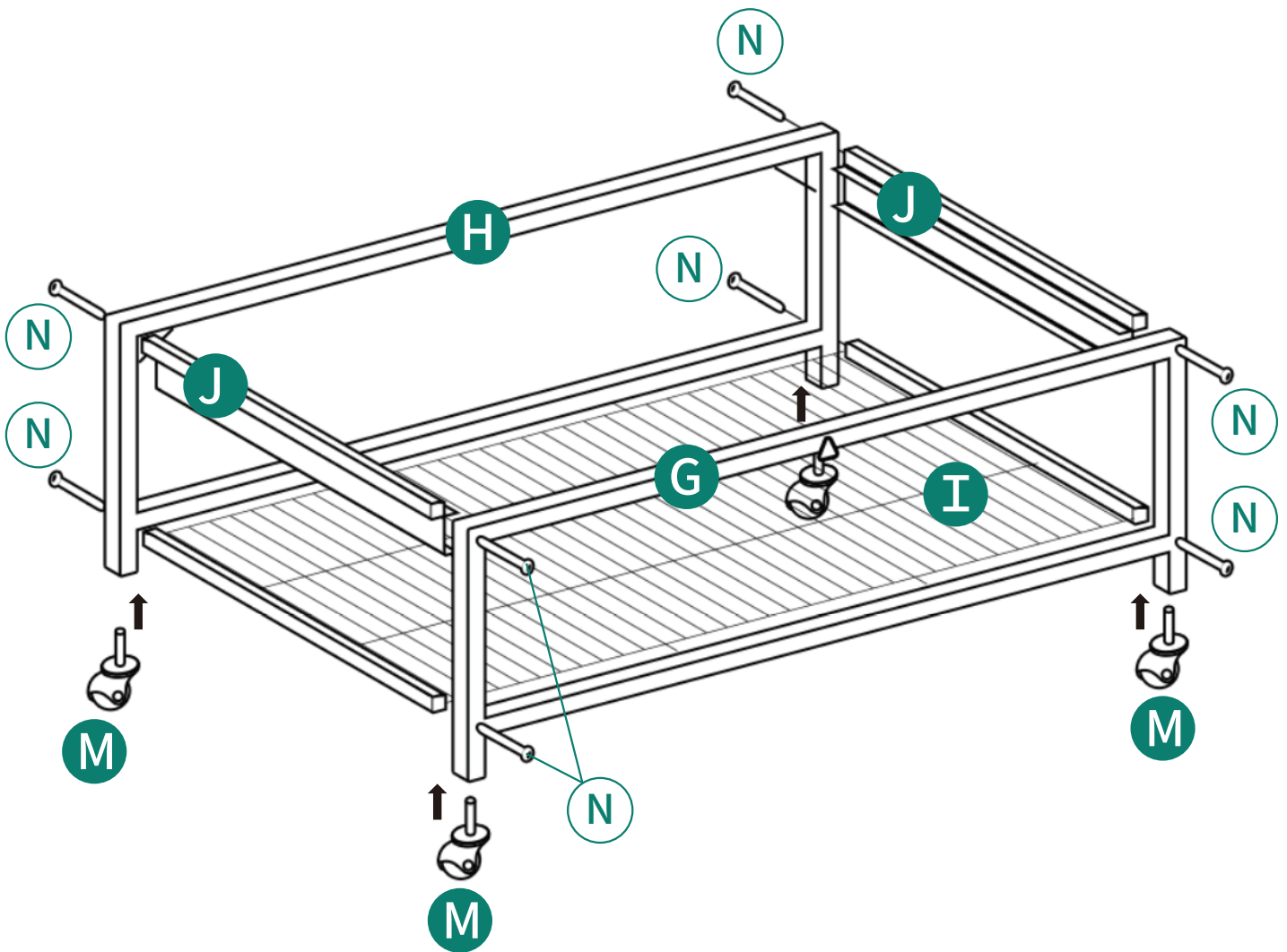

3



ⓔ 1pc



ⓕ 1pc



Ⓞ 4pcs

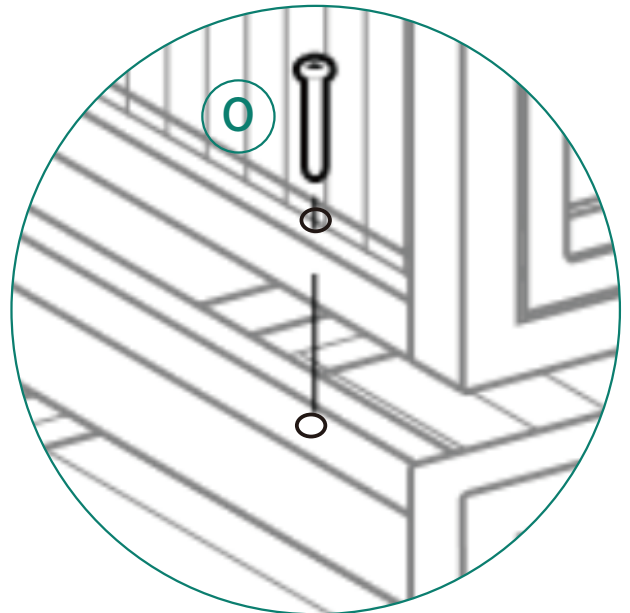
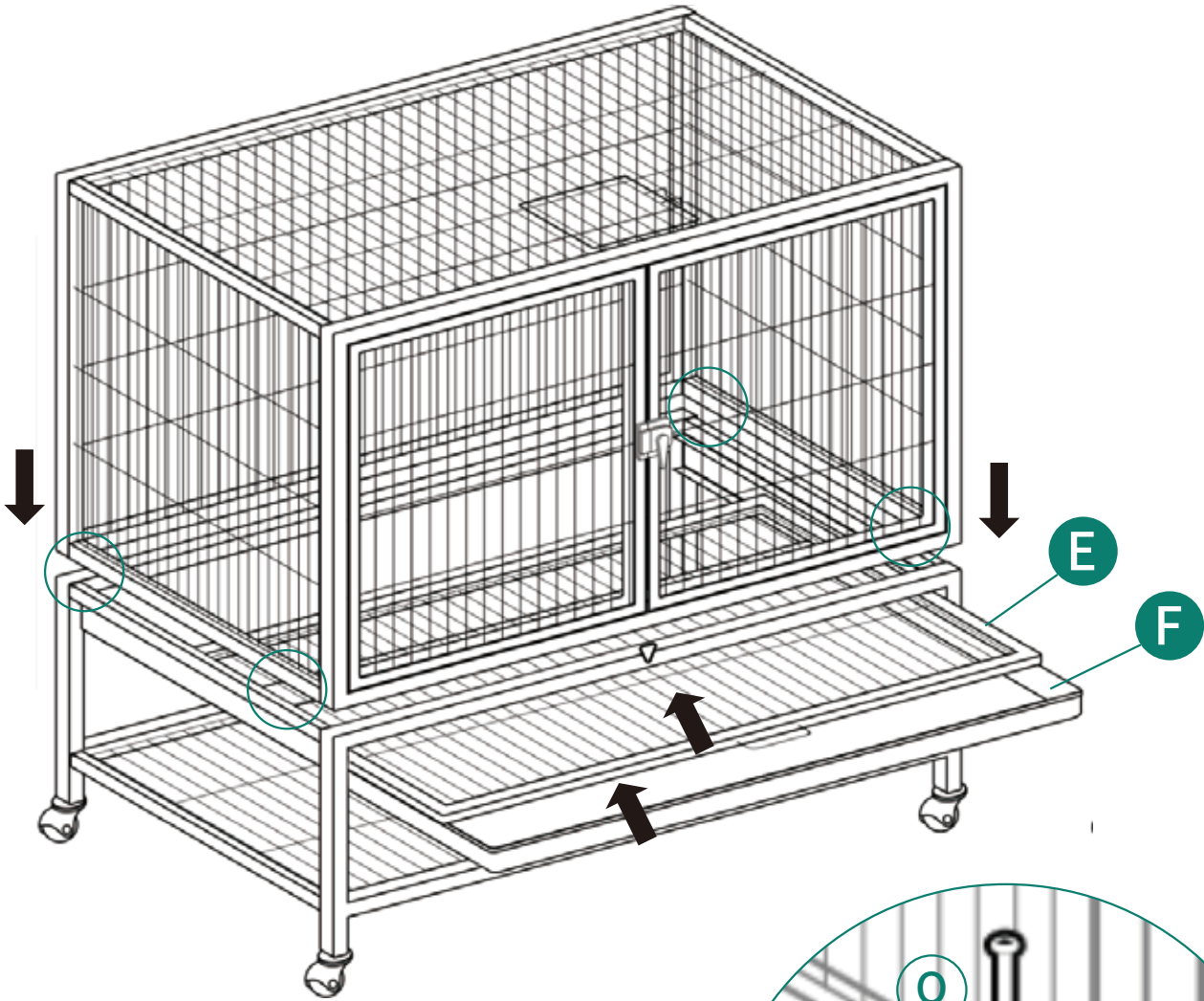

4



Ⓚ1pc



Ⓛ1pc

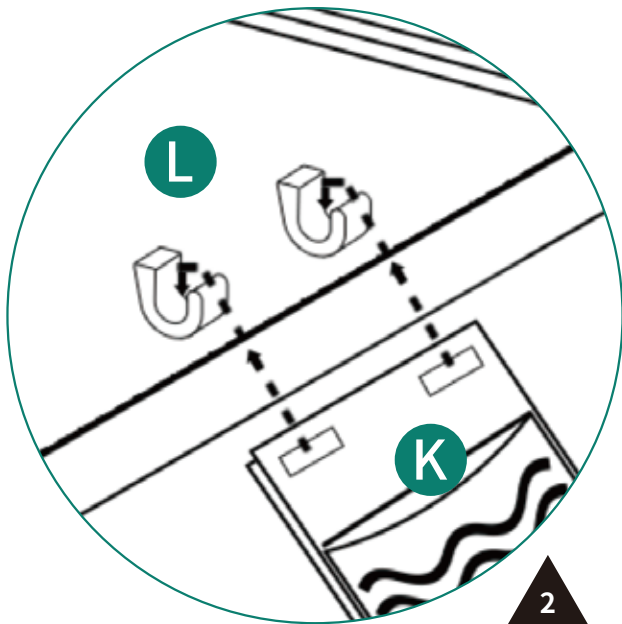
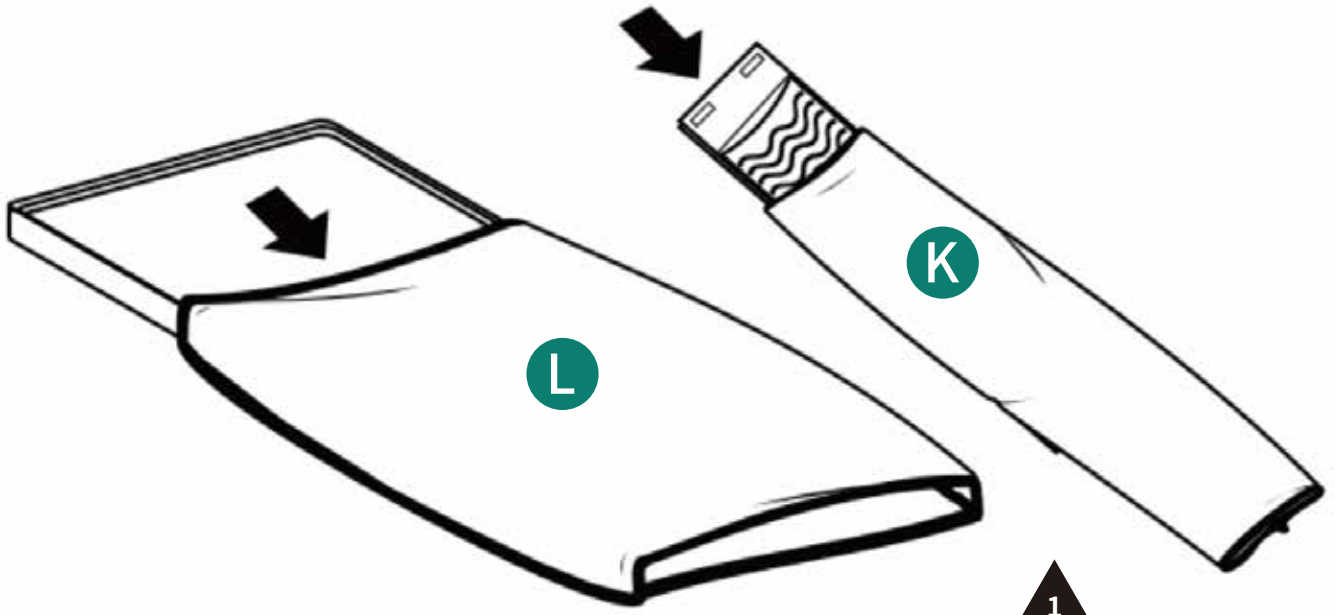

5

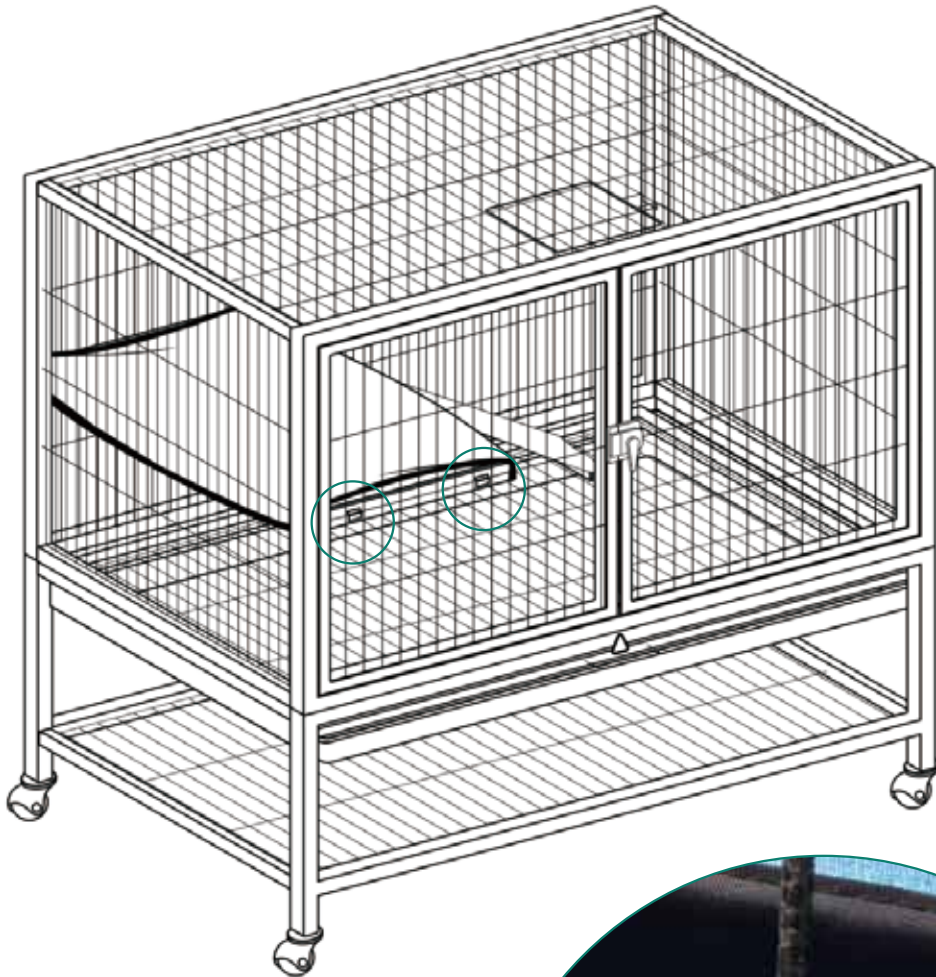

6

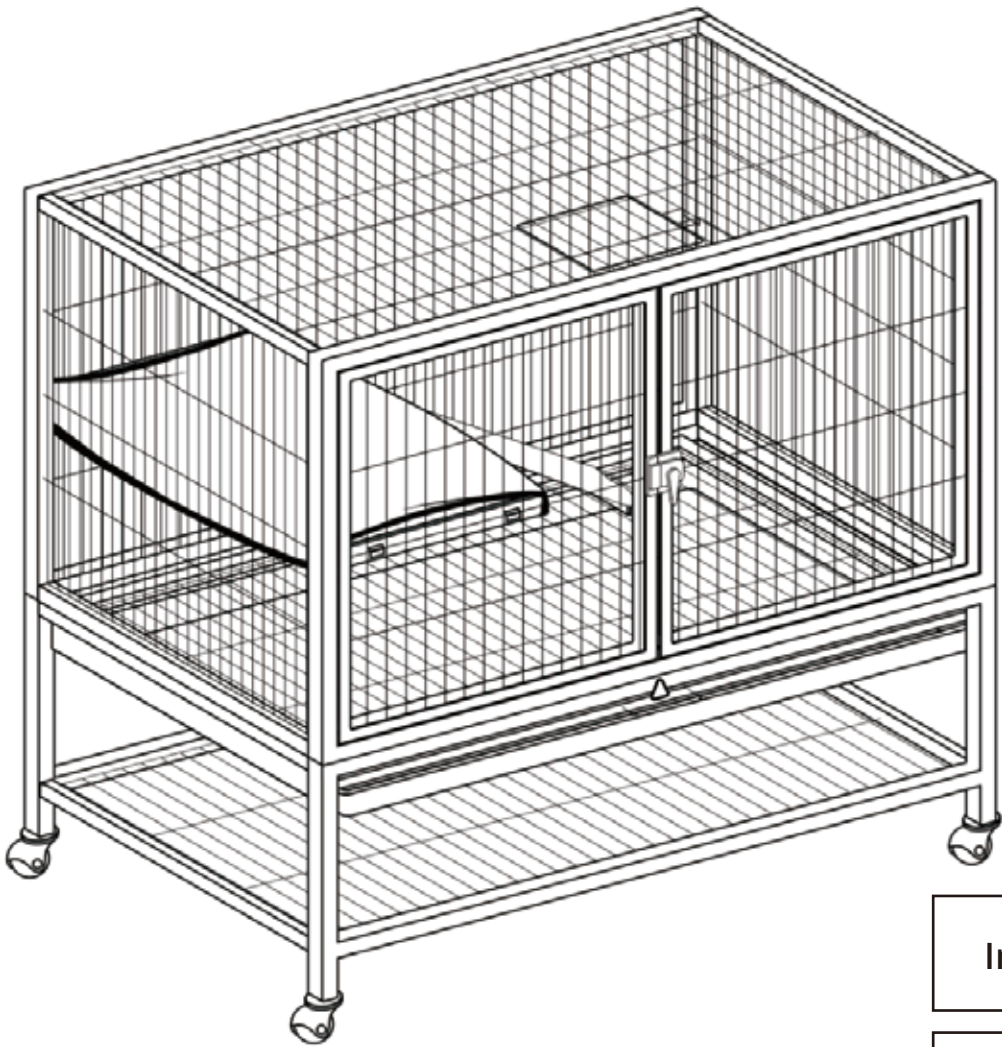

Installation Completed

Installation Abgeschlossen

Installation Complétée

Installazione Completata

Instalación Completada