









ASSEMBLY INSTRUCTIONS

SINGLE BED 3'0

A		cab. 17 - 1/4 x 110	08
B		cab. 13 - 7,0 x 120	03
C		cab. 13 - 7,0 x 100	03
D		1/4	08
E			01
F		10 x 40	04
G		4,0 x 35	24
H		space block	02
J		20g	01

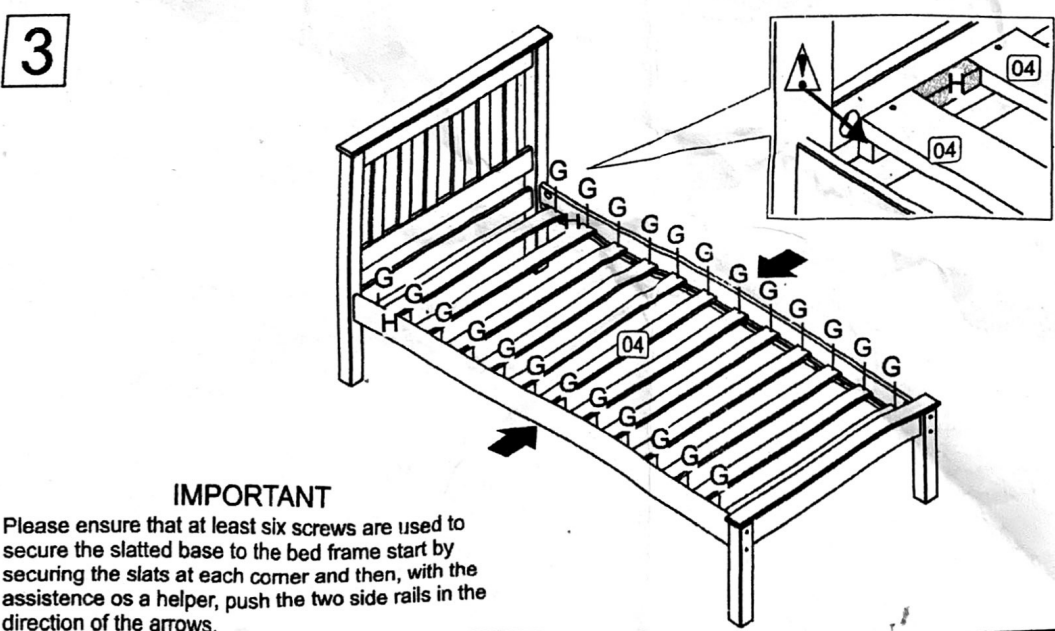
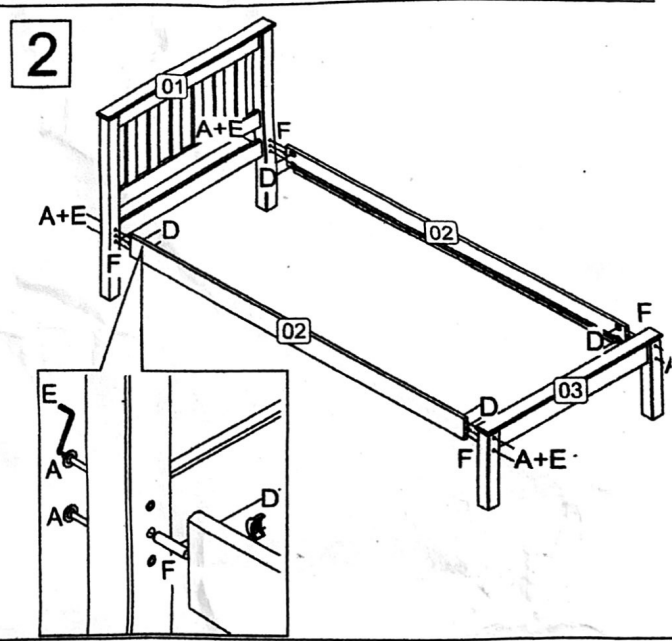
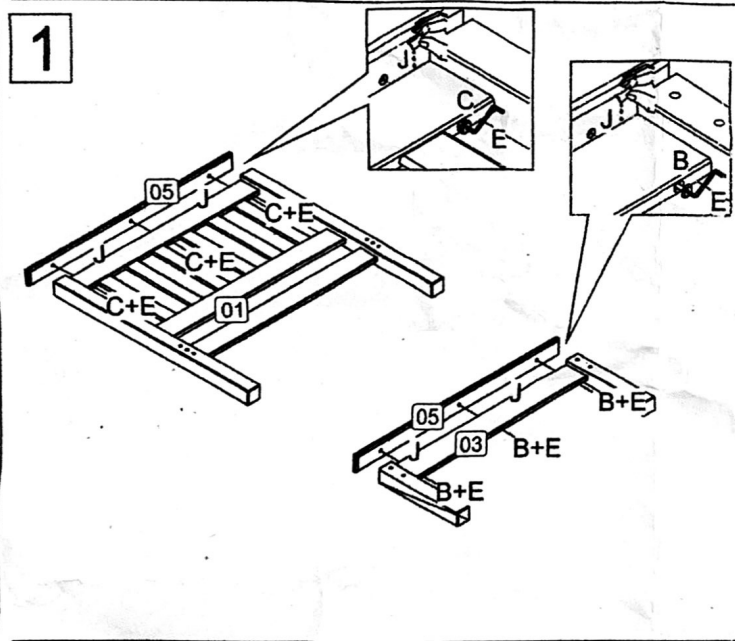
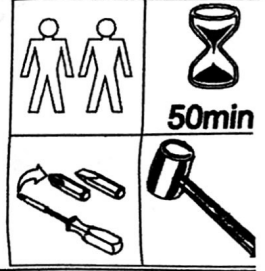
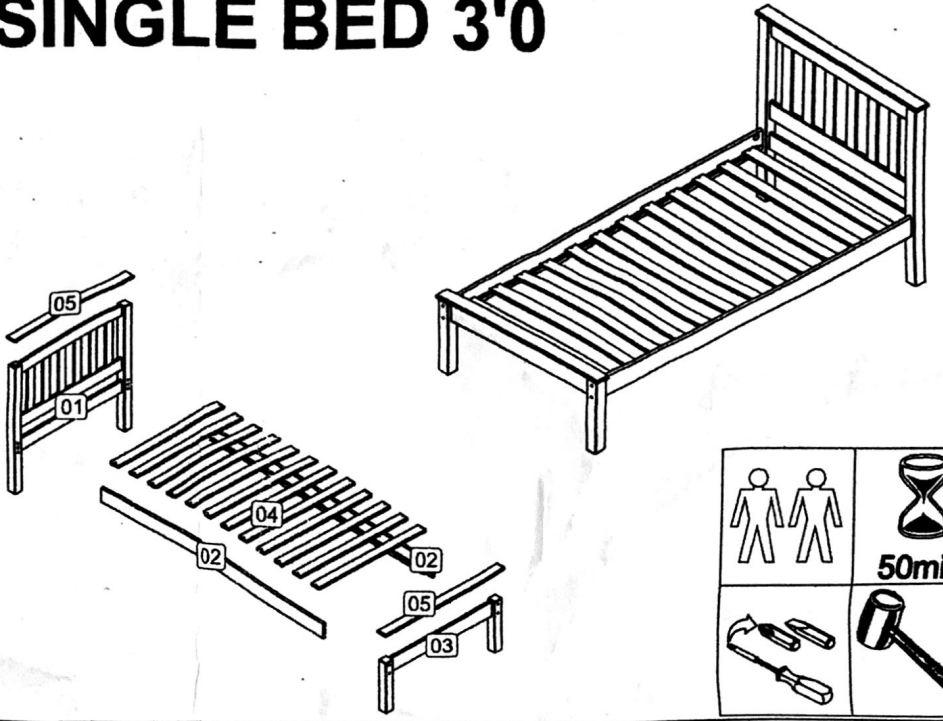

IMPORTANT

Please ensure that at least six screws are used to secure the slatted base to the bed frame start by securing the slats at each corner and then, with the assistance of a helper, push the two side rails in the direction of the arrows.